

Chip tantalum capacitors with open-function built-in

TCFG series

Semiconductor manufacturing technology has been used to include a temperature fuse in TCFG series capacitors. These capacitors feature low impedance and are ideal for digital circuits and low-voltage circuits in portable electronic equipment.

●Features

- 1) Open-function built into every package.
- 2) High capacitance in a small package.
- 3) Low impedance.
- 4) Use of semiconductor manufacturing technology provides high reliability.
- 5) Superb solderability.

●External dimensions (Units : mm)

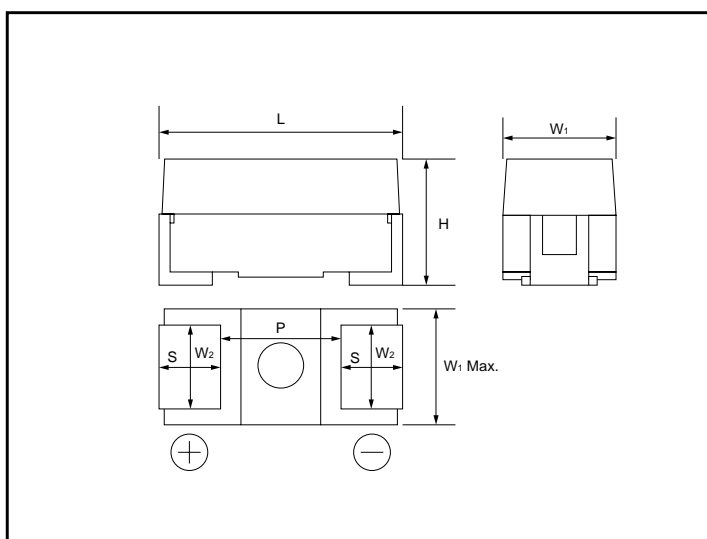

Case code	L	W ₁	W ₂	H	S	P
P (2012)	2.0 ± 0.2	1.25 ± 0.2	0.9 ± 0.2	Max.1.20	0.45 ± 0.3	1.3 ± 0.3
A (3216)	3.2 ± 0.2	1.6 ± 0.2	1.2 ± 0.2	1.6 ± 0.2	0.8 ± 0.3	1.6 ± 0.3
B (3528)	3.5 ± 0.2	2.8 ± 0.2	1.9 ± 0.2	1.9 ± 0.2	0.8 ± 0.3	1.9 ± 0.3

Tantalum capacitors

●Product designation

- When ordering, please specify the part No.
- Please check to be sure of what combination of features you wish to order.
- Fill in the blanks from left to right.

Three-digit number indicates the number of picofarads. The first two digits are the significant digits; the last digit gives the number of zeros.

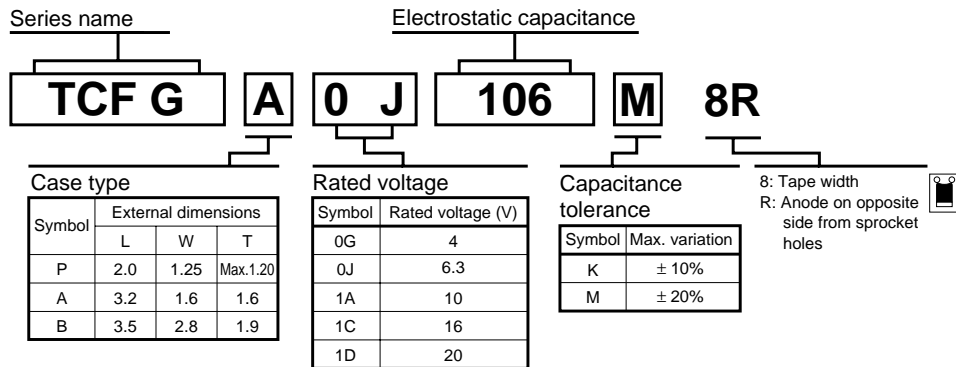

●Capacitance range

TCFG series

μF	Rated voltage (V. DC)				
	4 0G	6.3 0J	10 1A	16 1C	20 1D
0.68					
1.0			P	P A	A
1.5		P	P A	A	
2.2	P	P	P A	A	
3.3	P	P A	P A	A B	
4.7	P A	P A	P A B	A B	
6.8	P A	P A	A B	A B	
10	P A	P A B	A B	B	
15	P A B	A B	A B	B	
22	A B	A B	B	B	
33	A B	A B	B		
47	A B	B	B		
68	B	B			
100	B				

red characters : under the development

Tantalum capacitors

●Marking

The indications listed below should be given on the surface of a capacitor.

(1) Polarity : The polarity should be shown by \square bar.
(on the anode side)

(2) Rated DC voltage : Due to the small size of A case, a voltage code is used as shown below.

Voltage Code	Rated DC Voltage
g or G or OG	4.0
j or J or OJ	6.3
A or 1A	10.0
C or 1C	16.0
D	20.0

(3) Visual :
typical example

[P case]



note1) $\frac{j}{(1)} \frac{J}{(2)}$

[A case]



or



$\frac{j}{(1)} \frac{A7}{(2)}$ or $\frac{j}{(1)} \frac{106}{(2)}$

[B case]

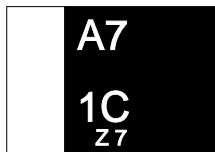

or



$\frac{A7}{(2)} \frac{1C}{(1)}$ or $\frac{10}{(2)} \frac{16V}{(1)}$

(1) voltage code (2) capacitance code

note2)

voltage code and capacitance code are variable with parts number.

Tantalum capacitors

●Characteristics

Item		Performance	Test methods / conditions (based on JIS C 5102, 5143)
Operating temperature		-55°C ~ +125°C	
Max. operating temperature at rated voltage		+85°C	
Rated voltage (V. DC)		4 6.3 10 16 20	
Derated voltage (V. DC)		2.5 4 6.3 10 13	at 125°C
Surge voltage (V. DC)		5.2 8 13 20 26	
Leakage current		Less than or equal to the larger of 0.5μA or 0.01CV. Details are given in Table 1, "Standard Product List".	Measured value 60s after application of rated voltage.
Capacitance range		1.0 ~ 100μF	Measured frequency: 120 ± 12Hz Measured voltage: 0.5Vrms + 1.5V. DC Measured circuit: equivalent series circuit
tanδ	P case	1μF to 4.7μF : 0.08 max. 6.8μF to 15μF : 0.10 max.	Measured frequency: 120 ± 12Hz Measured voltage: 0.5Vrms + 1.5V. DC Measured circuit: equivalent series circuit
	A case	1μF max.: 0.04 max. 1.5μF to 22μF : 0.06 max. 33μF to 47μF : 0.08 max.	
	B case	3.3μF to 47μF : 0.06 max. 68μF to 100μF : 0.08 max.	
Impedance	P case	27.5Ω max.	Measured frequency: 100 ± 10Hz Measured voltage: 0.5Vrms max. Measured circuit: equivalent series circuit
	A case	20.0Ω max.	
	B case	15.0Ω max.	
Resistance to solder heat	Appearance	No noticeable irregularities, and the markings must be easy to read.	Direct immersion into solder bath Solder bath temperature: 260 ± 5°C Immersion time: 5s Immersion cycles: 1 time
	L.C	Must satisfy the initial specified value.	
	ΔC / C	A · B case within ± 5% P case within ± 10%	
	tanδ	P case 1.5 times or less or initial specified tolerance. A · B case must satisfy the initial specified value.	
Open function operation		320°C for 20s or less	Direct immersion into solder bath (320 ± 5°C)
Temperature cycle	Appearance	No noticeable irregularities, and the markings must be easy to read.	The four cycles in the table below are repeated five times in succession.
	L.C	Must satisfy the initial specified value. P case = Within 150% of initial limit.	
	ΔC / C	P case within ± 10% A · B case within ± 5%	
	tanδ	P case 1.5 times or less or initial specified tolerance. A · B case must satisfy the initial specified value.	
Resistance to humidity (steady state)	Appearance	No noticeable irregularities, and the markings must be easy to read.	Measured after being left for 500 ± 12hrs. at 60 ± 2°C and 90 to 95% RH, then 1 to 2 hrs. at normal room temperature and humidity.
	L.C	Must satisfy the initial specified value.	
	ΔC / C	P case within ± 20% A · B case within ± 10%	
	tanδ	P case 1.5 times or less or initial specified tolerance. A · B case must satisfy the initial specified value.	

Tantalum capacitors

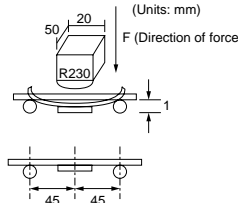
Item	Performance	Test methods / conditions (based on JIS C 5102,5143)
Temperature characteristics	Temperature	-55°C
	$\Delta C / C$	P case within +0% and -15% of the value before testing. A · B case within +10% and -0% of the value before testing.
	$\tan\delta$	P case within 1.5 times of the value before testing. A · B case must satisfy the initial specified value.
	L.C	-
	Temperature	+85°C
	$\Delta C / C$	P case within +0% and -15% of the value before testing. A · B case within +0% and -10% of the value before testing.
	$\tan\delta$	Must satisfy the initial specified value.
	L.C	Less than or equal to the larger of 5 μ A or 0.1CV.
	Temperature	+125°C
	$\Delta C / C$	P case within +20% and -0% of the value before testing. A · B case within +15% and -0% of the value before testing.
	$\tan\delta$	P case within 1.5 times of the value before testing. A · B case must satisfy the initial specified value.
	L.C	Less than or equal to the larger of 6.3 μ A or 0.125CV.
Surge resistance	Appearance	A · B case no noticeable irregularities, and the markings must be easy to read.
	L.C	Must satisfy the initial specified value.
	$\Delta C / C$	P case within $\pm 10\%$ A · B case within $\pm 5\%$
	$\tan\delta$	P case within 1.5 times of the value before testing. A · B case must satisfy the initial specified value.
High-temperature load	Appearance	No noticeable irregularities, and the markings must be easy to read.
	L. C	Must satisfy the initial specified value.
	$\Delta C / C$	Within $\pm 10\%$
	$\tan\delta$	P case within 1.5 times of the value before testing. A · B case must satisfy the initial specified value.
Terminal strength	Capacitance	Value must be stable during measurement.
	Appearance	No noticeable irregularities.
		<p>Apply the rated surge voltage for 30 \pm 5s at intervals of 5 \pm .05mins. 1000 times, with the temperature at 85 \pm 2°C.</p> <p>Temp. : 85 \pm 2°C Series Resistance : 3Ωmax. Applied voltage : rated voltage Test time : P case 1000 \pm $\frac{36}{8}$ hrs A · B case 2000 \pm $\frac{73}{8}$ hrs measre made after pieces shall be left for 1 to 2 hrs under room temp. and room humidity after test.</p> <p>Apply pressure to the device using the specified tool for 5s so that the center deflection is 1mm (see below).</p>  <p>(Units: mm)</p> <p>F (Direction of force)</p>

Tantalum capacitors

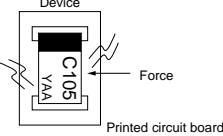
Item		Performance	Test conditions
Adhesion		Terminals must not detach.	<p>With the device mounted on the printed circuit board, apply a force of $0.5\text{kg} \cdot \text{f}$ from each side for a period of $10 \pm 1\text{s}$.</p> 
External dimensions		Refer to "External dimensions"	Measure using slide calipers that meet the requirements of JIS B7507 Class 2.
Markings	Resistance to solvents	Marking must be easy to read.	Immerse in isopropyl alcohol for $30 \pm 5\text{s}$.
Solderability Inspect the solder cover of the terminals using a solder immersion test		At least 3 / 4 of the surface of the immersed terminals must be covered with new solder.	<p>Immersion speed: $25 \pm 2.5\text{mm} / \text{s}$ Pre-processing (accelerated aging): leave for 1hr over boiling distilled water. Solder temperature: $235 \pm 5^\circ\text{C}$ Immersion time: $2 \pm 0.5\text{s}$ Solder type: H63A Flux: rosin 25%, IPA 75%</p>
Resistance to vibration	Capacitance	Value must be stable during measurement.	Vibrate in the X / Y axis at frequencies of 10~55~10Hz / minute for two hours each, with a total vibration amplitude of 1.5mm.
	Appearance	No noticeable irregularities.	
Reverse polarity withstanding voltage	Appearance	No noticeable irregularities, and the markings must be easy to read.	Apply either 0.1 times the rated voltage, or 3V, whichever is smaller, via a series resistor of $3\Omega_{\text{max}}$ and $0.1\Omega_{\text{min}}$ at a temperature of $85 \pm 2^\circ\text{C}$.
	L.C	Must be less than or equal to twice the initial specified value.	
	$\Delta C / C$	Within $\pm 10\%$ of the value before the test.	
	$\tan\delta$	Must be less than or equal to 1.5 times the initial specified value.	

Tantalum capacitors

● Table 1 Standard list, TCFG series

(P : 2012 A : 3216 B : 3528)

Part No.	Rated voltage at 85°C (V)	Derated voltage at 125°C (V)	Surge voltage at 85°C (V)	Capacitance (μF)	Tolerance (%)	Leakage current at 25°C 1VV.60s (μA)	DF 120Hz 25°C (%)	Case code
TCF GP 0G 225□	4	2.5	5.2	2.2	±20,10	0.5	8	P
TCF GP 0G 335□	4	2.5	5.2	3.3	±20,10	0.5	8	P
TCF GP 0G 475□	4	2.5	5.2	4.7	±20,10	0.5	8	P
TCF GA 0G 475□	4	2.5	5.2	4.7	±20,10	0.5	6	A
TCF GP 0G 685□	4	2.5	5.2	6.8	±20,10	0.5	10	P
TCF GA 0G 685□	4	2.5	5.2	6.8	±20,10	0.5	6	A
TCF GP 0G 106□	4	2.5	5.2	10	±20,10	0.5	10	P
TCF GA 0G 106□	4	2.5	5.2	10	±20,10	0.5	6	A
TCF GP 0G 156□	4	2.5	5.2	15	±20,10	0.6	10	P
TCF GA 0G 156□	4	2.5	5.2	15	±20,10	0.6	6	A
TCF GB 0G 156□	4	2.5	5.2	15	±20,10	0.6	6	B
TCF GA 0G 226□	4	2.5	5.2	22	±20,10	0.9	6	A
TCF GB 0G 226□	4	2.5	5.2	22	±20,10	0.9	6	B
TCF GA 0G 336□	4	2.5	5.2	33	±20,10	1.3	8	A
TCF GB 0G 336□	4	2.5	5.2	33	±20,10	1.3	6	B
TCF GA 0G 476□	4	2.5	5.2	47	±20,10	1.9	8	A
TCF GB 0G 476□	4	2.5	5.2	47	±20,10	1.9	6	B
TCF GB 0G 686□	4	2.5	5.2	68	±20,10	2.7	8	B
TCF GB 0G 107□	4	2.5	5.2	100	±20,10	4.0	8	B
TCF GP 0J 155□	6.3	4	8	1.5	±20,10	0.5	8	P
TCF GP 0J 225□	6.3	4	8	2.2	±20,10	0.5	8	P
TCF GP 0J 335□	6.3	4	8	3.3	±20,10	0.5	8	P
TCF GA 0J 335□	6.3	4	8	3.3	±20,10	0.5	6	A
TCF GP 0J 475□	6.3	4	8	4.7	±20,10	0.5	8	P
TCF GA 0J 475□	6.3	4	8	4.7	±20,10	0.5	6	A
TCF GP 0J 685□	6.3	4	8	6.8	±20,10	0.5	10	P
TCF GA 0J 685□	6.3	4	8	6.8	±20,10	0.5	6	A
TCF GP 0J 106□	6.3	4	8	10	±20,10	0.6	10	P
TCF GA 0J 106□	6.3	4	8	10	±20,10	0.6	6	A
TCF GB 0J 106□	6.3	4	8	10	±20,10	0.6	6	B
TCF GA 0J 156□	6.3	4	8	15	±20,10	0.9	6	A
TCF GB 0J 156□	6.3	4	8	15	±20,10	0.9	6	B
TCF GA 0J 226□	6.3	4	8	22	±20,10	1.4	6	A
TCF GB 0J 226□	6.3	4	8	22	±20,10	1.4	6	B
TCF GA 0J 336□	6.3	4	8	33	±20,10	2.1	8	A
TCF GB 0J 336□	6.3	4	8	33	±20,10	2.1	6	B
TCF GB 0J 476□	6.3	4	8	47	±20,10	3.0	6	B
TCF GB 0J 686□	6.3	4	8	68	±20,10	4.3	8	B

□ Tolerance
(M : ±20%, K : ±10%)

TCFG series

Tantalum capacitors

(P : 2012 A : 3216 B : 3528)

Part No.	Rated voltage at 85°C (V)	Derated voltage at 125°C (V)	Surge voltage at 85°C (V)	Capacitance (μF)	Tolerance (%)	Leakage current at 25°C 1VV.60s (μA)	DF 120Hz 25°C (%)	Case code
TCF GP 1A 105□	10	6.3	13	1.0	±20,10	0.5	8	P
TCF GP 1A 155□	10	6.3	13	1.5	±20,10	0.5	8	P
TCF GA 1A 155□	10	6.3	13	1.5	±20,10	0.5	6	A
TCF GP 1A 255□	10	6.3	13	2.2	±20,10	0.5	8	P
TCF GA 1A 225□	10	6.3	13	2.2	±20,10	0.5	6	A
TCF GP 1A 335□	10	6.3	13	3.3	±20,10	0.5	8	P
TCF GA 1A 335□	10	6.3	13	3.3	±20,10	0.5	6	A
TCF GP 1A 475□	10	6.3	13	4.7	±20,10	0.5	8	P
TCF GA 1A 475□	10	6.3	13	4.7	±20,10	0.5	6	A
TCF GB 1A 475□	10	6.3	13	4.7	±20,10	0.5	6	B
TCF GA 1A 685□	10	6.3	13	6.8	±20,10	0.7	6	A
TCF GB 1A 685□	10	6.3	13	6.8	±20,10	0.7	6	B
TCF GA 1A 106□	10	6.3	13	10	±20,10	1.0	6	A
TCF GB 1A 106□	10	6.3	13	10	±20,10	1.0	6	B
TCF GA 1A 156□	10	6.3	13	15	±20,10	1.5	6	A
TCF GB 1A 156□	10	6.3	13	15	±20,10	1.5	6	B
TCF GB 1A 226□	10	6.3	13	22	±20,10	2.2	6	B
TCF GB 1A 336□	10	6.3	13	33	±20,10	3.3	6	B
TCF GB 1A 476□	10	6.3	13	47	±20,10	4.7	6	B
TCF GP 1C 105□	16	10	20	1.0	±20,10	0.5	8	P
TCF GA 1C 105□	16	10	20	1.0	±20,10	0.5	4	A
TCF GA 1C 155□	16	10	20	1.5	±20,10	0.5	6	A
TCF GA 1C 225□	16	10	20	2.2	±20,10	0.5	6	A
TCF GA 1C 335□	16	10	20	3.3	±20,10	0.5	6	A
TCF GB 1C 335□	16	10	20	3.3	±20,10	0.5	6	B
TCF GA 1C 475□	16	10	20	4.7	±20,10	0.8	6	A
TCF GB 1C 475□	16	10	20	4.7	±20,10	0.8	6	B
TCF GA 1C 685□	16	10	20	6.8	±20,10	1.1	6	A
TCF GB 1C 685□	16	10	20	6.8	±20,10	1.1	6	B
TCF GB 1C 106□	16	10	20	10	±20,10	1.6	6	B
TCF GB 1C 156□	16	10	20	15	±20,10	2.4	6	B
TCF GB 1C 226□	16	10	20	22	±20,10	3.5	6	B
TCF GA 1D 105□	20	13	26	1.0	±20,10	0.5	4	A

□ Tolerance
(M : ±20%, K : ±10%)

Tantalum capacitors

●Packaging specifications

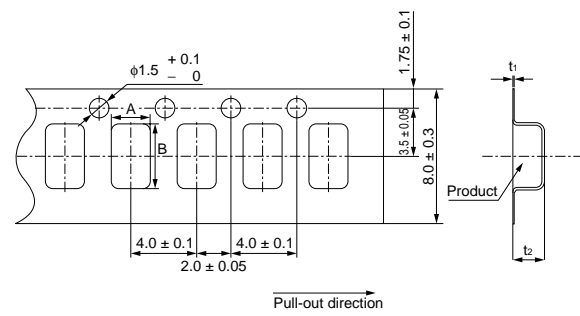
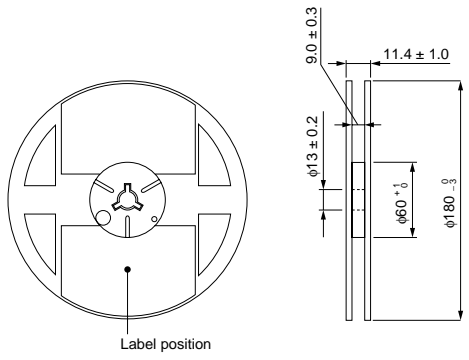
Taping	Reel																				
<p>TCFG</p>  <table border="1" style="margin-top: 10px; border-collapse: collapse; width: 100%;"> <thead> <tr> <th>Case code</th> <th>A ± 0.1</th> <th>B ± 0.1</th> <th>t₁ ± 0.05</th> <th>t₂ ± 0.1</th> </tr> </thead> <tbody> <tr> <td>P (2012)</td> <td>1.55</td> <td>2.3</td> <td>0.25</td> <td>1.5</td> </tr> <tr> <td>A (3216)</td> <td>1.9</td> <td>3.5</td> <td>0.25</td> <td>1.9</td> </tr> <tr> <td>B (3528)</td> <td>3.3</td> <td>3.8</td> <td>0.25</td> <td>2.2</td> </tr> </tbody> </table> <p style="font-size: small; margin-top: 5px;">Some emboss tapes have the center hole on its bottom.</p>	Case code	A ± 0.1	B ± 0.1	t ₁ ± 0.05	t ₂ ± 0.1	P (2012)	1.55	2.3	0.25	1.5	A (3216)	1.9	3.5	0.25	1.9	B (3528)	3.3	3.8	0.25	2.2	<p>Plastic reel</p>  <p style="text-align: right; font-size: small; margin-top: 10px;">EIAJ ETX - 7001comformed</p>
Case code	A ± 0.1	B ± 0.1	t ₁ ± 0.05	t ₂ ± 0.1																	
P (2012)	1.55	2.3	0.25	1.5																	
A (3216)	1.9	3.5	0.25	1.9																	
B (3528)	3.3	3.8	0.25	2.2																	

●Packaging style

Part No.	Package type	Packaging style		Symbol	Basic ordering unit (pcs)
TCFG	Taping	Plastic taping	φ180 mm reel	R	2,000

Tantalum capacitors

● Electrical characteristics and operation notes

(1) Soldering conditions (soldering temperature and soldering time)

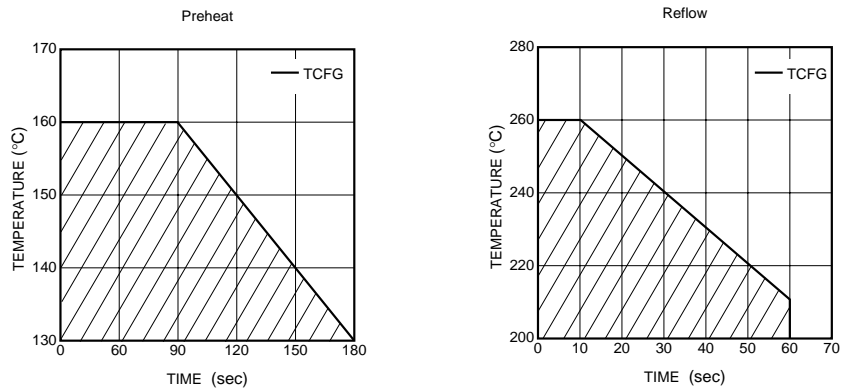

Fig.1 Reflow (Infrared Ray, Hot Plate, Hot Air)

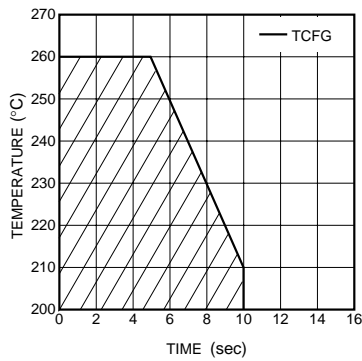

Fig.2 Flow (Dipping wave soldering)

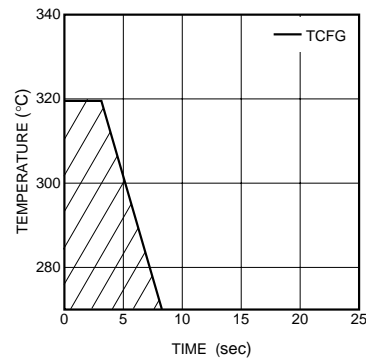

Fig.3 Hand soldering (soldering gun output: 30W or less)

(2) Leakage current-to-voltage ratio

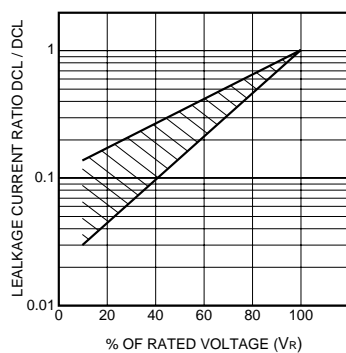

Fig.4

Tantalum capacitors

(3) Derating voltage as function of temperature

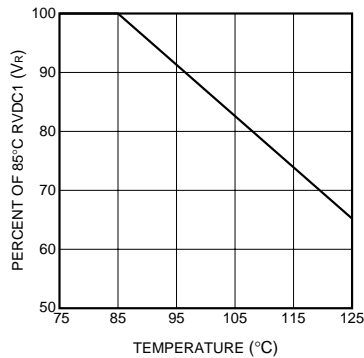

Fig.5

85°C		125°C	
Rated Voltage (V.DC)	Surge Voltage (V.DC)	Category Voltage (V.DC)	Surge Voltage (V.DC)
4	5.2	2.5	3.4
6.3	8	4	5
10	13	6.3	9
16	20	10	12
20	26	13	16

(4) Reliability

The malfunction rate of tantalum solid state electrolytic capacitors varies considerably depending on the conditions of usage (ambient temperature, applied voltage, circuit resistance).

Formula for calculating malfunction rate

$$\lambda_p = \lambda_b \times (\pi_E \times \pi_{SR} \times \pi_Q \times \pi_{CV})$$

- λ_p : Malfunction rate stemming from operation
- λ_b : Basic malfunction rate
- π_E : Environmental factors
- π_{SR} : Series resistance
- π_Q : Level of malfunction rate
- π_{CV} : Capacitance

For details on how to calculate the malfunction rate stemming from operation, see the tantalum solid state electrolytic capacitors column in MIL-HDBK-217.

Malfunction rate as function of operating temperature and rated voltage

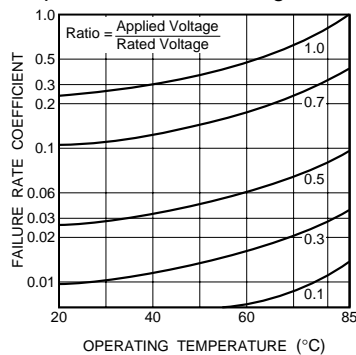

Fig.6

Malfunction rate as function of circuit resistance (Ω/V)

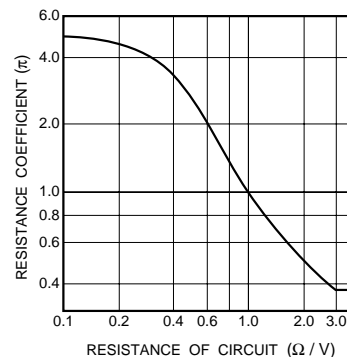

Fig.7

Tantalum capacitors

(5) External temperature vs. fuse blowout sur-

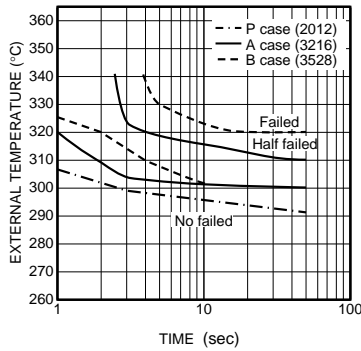

Fig.8

(6) Power vs. fuse blowout characteristics / Product

face temperature

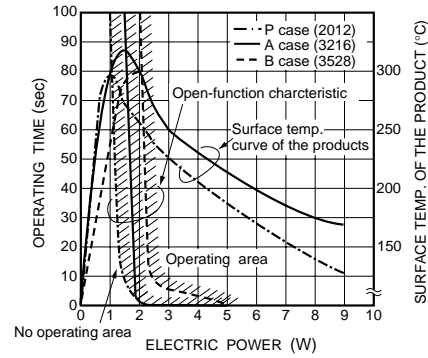

Fig.9

Note: Solder the chip at 300°C or less. If it is soldered using a temperature higher than 300°C, open function built-in may operate.

(7) Maximum power dissipation

Warming of the capacitor due to ripple voltage balances with warming caused by Joule heating and by radiated heat. Maximum allowable warming of the capacitor is to 5°C above ambient temperature. When warming exceeds 5°C, it can damage the dielectric and cause a short circuit.

Power dissipation (P) = $I^2 \cdot R$

Ripple current

P : As shown in table at right

R : Equivalent series resistance

Notes:

1. Please be aware that when case size is changed, maximum allowable power dissipation is reduced.
2. Maximum power dissipation varies depending on the package. Be sure to use a case which will keep warming within the limits shown in the table below.

Allowable power dissipation (W) and maximum temperature rising

Ambient temp.	+25°C	+55°C	+85°C	+125°C
Case				
P case (2012)	0.025	0.022	0.020	0.010
A case (3216)	0.070	0.063	0.056	0.028
B case (3528)	0.080	0.072	0.064	0.032
Max. temp. rise	5	5	5	2

Tantalum capacitors

(8) Impedance frequency characteristics

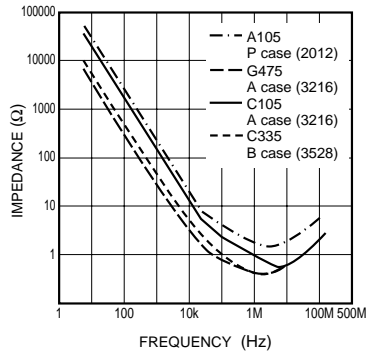

Fig.10

(9) ESR frequency characteristics

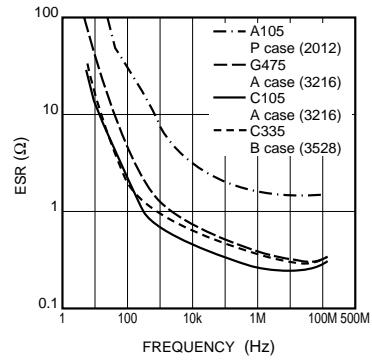

Fig.11

(10) Temperature characteristics

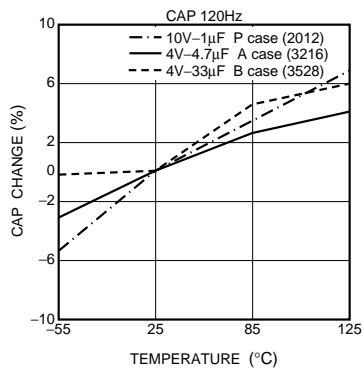

Fig.12

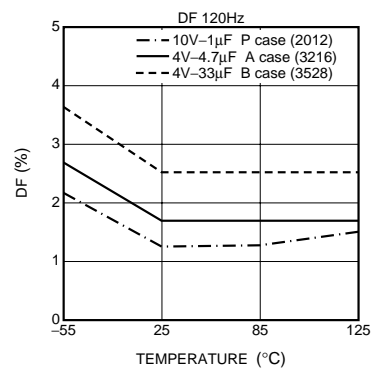

Fig.13

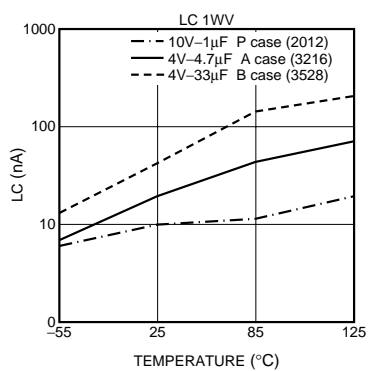

Fig.14

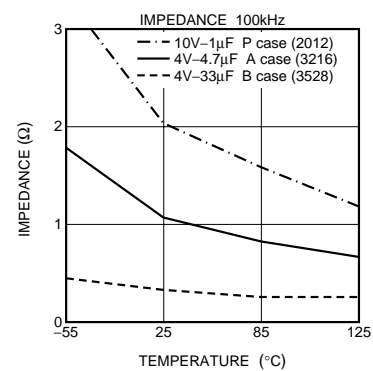

Fig.15

Tantalum capacitors

Inrush current

Beware of inrush current.
Inrush currents are inversely proportional to ESR. Large inrush currents can cause component failure.

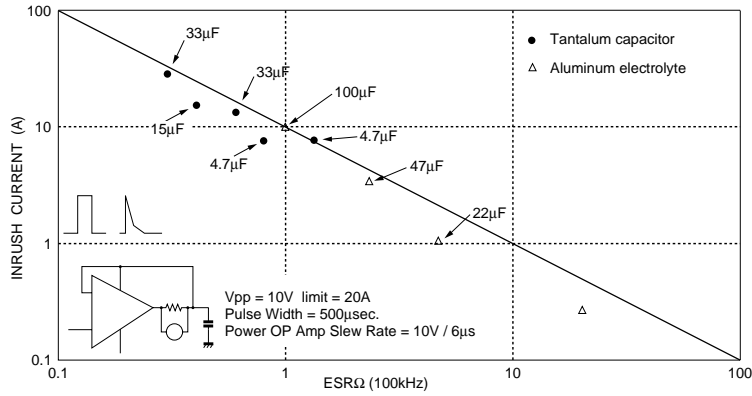

Fig.16 Maximum inrush current and ESR

Inrush current can be limited by means of a protective resistor.

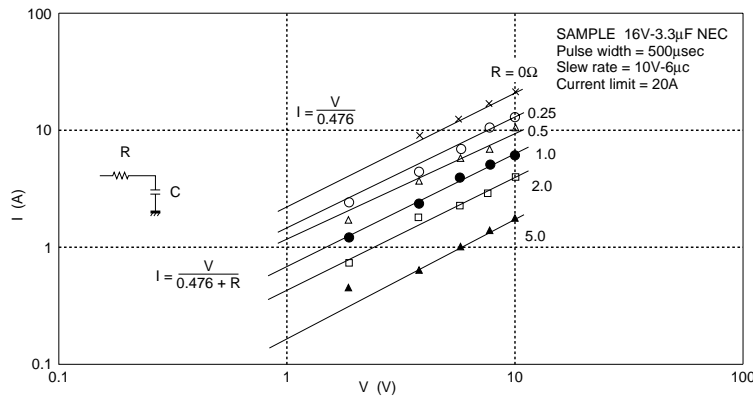

Fig.17 I_{max} change due to protective resistor R

(11) Ultrasonic cleaning

Carry out cleaning under the mildest conditions possible. The internal element of a tantalum capacitor are larger than those of a transistor or diode, so it is not as resistant to ultrasonic waves.

Example : water
Propagation speed 1500m / s
Solvent density 1g / cm³

Frequency and wavelength

Frequency	Wavelength
20kHz	7.5cm
28kHz	5.3cm
50kHz	3.0cm

Tantalum capacitors

Precautions

1) Do not allow solvent to come to a boil (kinetic energy increases).

- Ultrasonic output 0.5W / cm² or less
- Use a solvent with a high boiling point.
- Lower solvent temperature.

2) Ultrasonic cleaning frequency

28 kHz or less

3) Keep cleaning time as short as possible.

4) Move item being cleaned.

Standing waves caused by the ultrasonic waves can cause stress to build up in part of the item being cleaned.

Reference

$$\text{Kinetic energy} = 2 \times \pi \times \text{frequency} \times \sqrt{\frac{2 \times \text{ultrasonic output}}{\text{propagation speed} \times \text{solvent density}}}$$