

TENTATIVE TOSHIBA CCD LINEAR IMAGE SENSOR CCD(Charge Coupled Device)

TCD1502C

The TCD1502C is a high sensitive and low dark current 5000 elements CCD image sensor.

The sensor is designed for facsimile, imagescanner and OCR.

The device contains a row of 5000 elements photodiodes which provide a 16 lines/mm (400DPI) across a A3 size paper. The device is operated by 5V (pulse), and 12V power supply.

FEATURES

- Number of Image Sensing Elements : 5000 elements
- Image Sensing Element Size : 7 μ m by 7 μ m on 7 μ m centers
- Photo Sensing Region : High sensitive and low voltage dark signal pn photodiode
- Clock : 2 phase (5V)
- Package : 22pin DIP

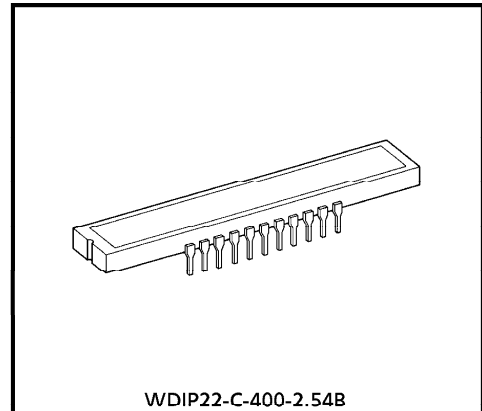

Weight : 5.4g (Typ.)

MAXIMUM RATINGS (Note 1)

CHARACTERISTIC	SYMBOL	RATING	UNIT
Clock Pulse Voltage	V_{ϕ}	- 0.3~8	V
Shift Pulse Voltage	V_{SH}		
Reset Pulse Voltage	V_{RS}		
Clamp Pulse Voltage	V_{CP}		
Power Supply Voltage	V_{OD}	- 0.3~15	
Operating Temperature	T_{opr}	- 25~60	°C
Storage Temperature	T_{stg}	- 40~100	°C

(Note 1) All voltage are with respect to SS terminals (Ground).

PIN CONNECTIONS

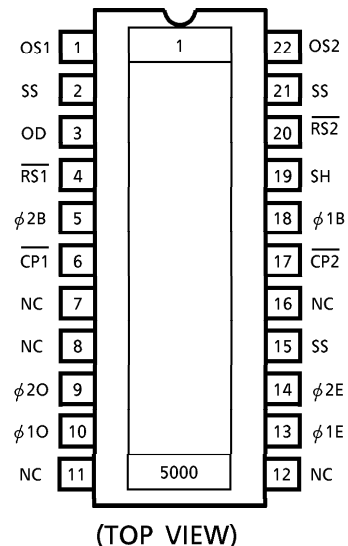

961001EBA2

● TOSHIBA is continually working to improve the quality and the reliability of its products. Nevertheless, semiconductor devices in general can malfunction or fail due to their inherent electrical sensitivity and vulnerability to physical stress. It is the responsibility of the buyer, when utilizing TOSHIBA products, to observe standards of safety, and to avoid situations in which a malfunction or failure of a TOSHIBA product could cause loss of human life, bodily injury or damage to property. In developing your designs, please ensure that TOSHIBA products are used within specified operating ranges as set forth in the most recent products specifications. Also, please keep in mind the precautions and conditions set forth in the TOSHIBA Semiconductor Reliability Handbook.

CIRCUIT DIAGRAM

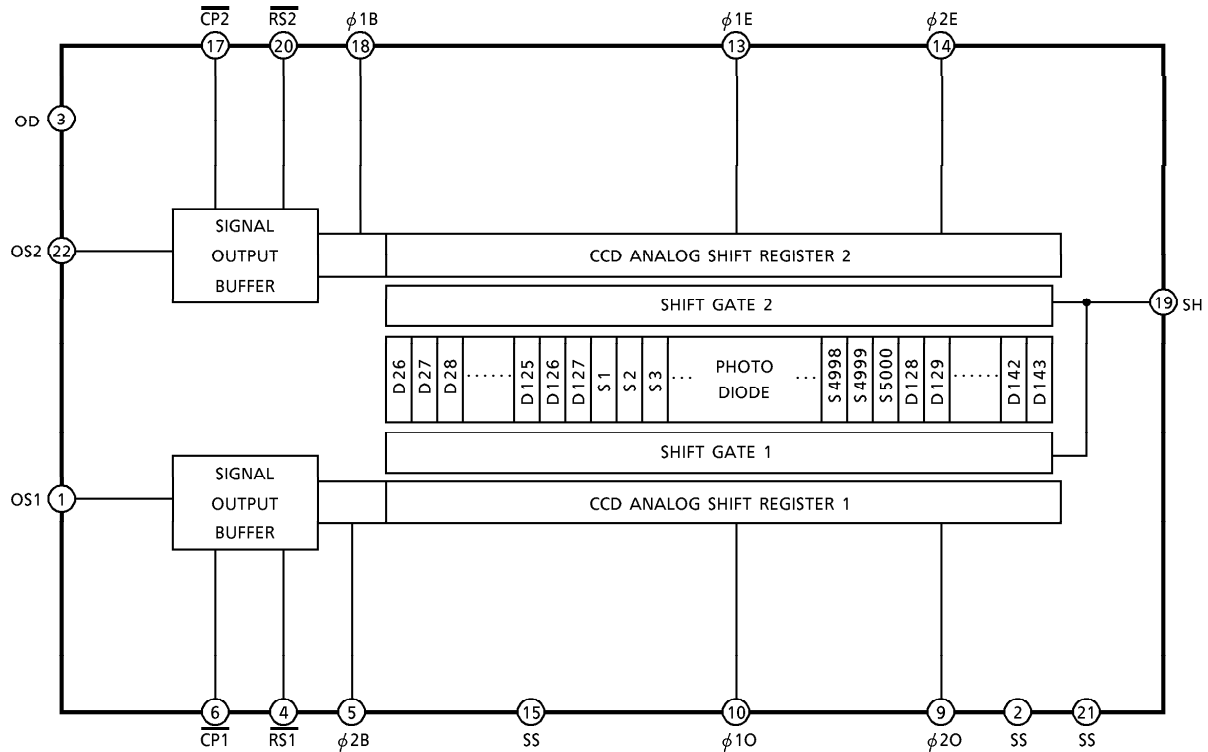

PIN NAME

$\phi 1E, O$	Clock (Phase 1)
$\phi 2E, O$	Clock (Phase 2)
$\phi 1B$	Final Stage Clock (Phase 1)
$\phi 2B$	Final Stage Clock (Phase 2)
SH	Shift Gate
RS	Reset Gate
CP	Clamp Gate
OS1	Signal Output 1
OS2	Signal Output 2
OD	Power
SS	Ground
NC	Non Connection

961001EBA2'

● The products described in this document are subject to foreign exchange and foreign trade control laws.
 ● The information contained herein is presented only as a guide for the applications of our products. No responsibility is assumed by TOSHIBA CORPORATION for any infringements of intellectual property or other rights of the third parties which may result from its use. No license is granted by implication or otherwise under any intellectual property or other rights of TOSHIBA CORPORATION or others.
 ● The information contained herein is subject to change without notice.

OPTICAL / ELECTRICAL CHARACTERISTICS

(Ta = 25°C, V_{OD} = 12V, V_φ = V_{SH} = V_{RS} = V_{CP} = 5V, f_φ = 1MHz,

t_{INT} (INTEGRATION TIME) = 10ms, LIGHT SOURCE = DAYLIGHT FLUORESCENT LAMP,

LOAD RESISTANCE = 100kΩ)

CHARACTERISTIC	SYMBOL	MIN.	TYP.	MAX.	UNIT	NOTE
Sensitivity	R	7.2	9	10.8	V / lx·s	
Photo Response Non Uniformity	PRNU	—	—	10	%	(Note 2)
	PRNU (3)	—	4	8	mV	(Note 8)
Saturation Output Voltage	V _{SAT}	1.5	2	—	V	(Note 3)
Saturation Exposure	SE	0.14	0.22	—	lx·s	(Note 4)
Dark Signal Voltage	V _{DRK}	—	1	2.5	mV	(Note 5)
Dark Signal Non Uniformity	DSNU	—	1	2.5	mV	(Note 5)
DC Power Dissipation	P _D	—	300	364	mW	
Total Transfer Efficiency	TTE	92	—	—	%	
Output Impedance	Z _O	—	0.5	1	kΩ	
Dynamic Range	DR	—	2000	—	—	(Note 6)
DC Signal Output Voltage	V _{OS1}	3.5	4.5	6	V	(Note 7)
	V _{OS2}	3.5	4.5	6		
DC Differential Error Voltage	V _{OS1} -V _{OS2}	—	—	300	mV	

(Note 2) Measured at 50% of SE (Typ.)

$$\text{Definition of PRNU : PRNU} = \frac{\Delta x}{\bar{x}} \times 100 (\%)$$

Where \bar{x} is average of total signal outputs and Δx is maximum deviation from \bar{x} under uniform illumination. (Channel 1)

In the case of 2500 elements (Channel 2), the condition is the same as above too.

(Note 3) V_{SAT} is defined as minimum saturation output voltage of all effective pixels.

$$\text{(Note 4) Definition of SE : SE} = \frac{V_{SAT}}{R} (\text{lx}\cdot\text{s})$$

(Note 5) V_{DRK} is defined as average dark signal voltage of all effective pixels.
 DSNU is defined as different voltage between V_{DRK} and V_{MDK} when V_{MDK} is maximum dark signal voltage.

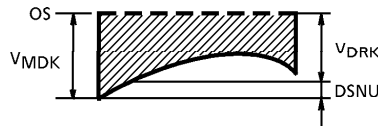

(Note 6) Definition of DR : $DR = \frac{V_{SAT}}{V_{DRK}}$

V_{DRK} is proportional to t_{INT} (Integration Time).
 So the shorter t_{INT} condition makes wider DR values.

(Note 7) DC signal output voltage and DC compensation output voltage are defined as follows:

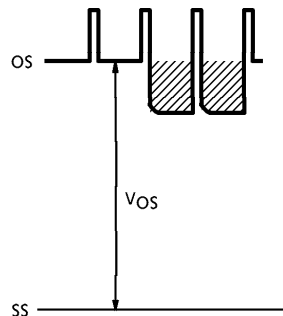

(Note 8) PRNU (3) is defined as maximum voltage with next pixel, where measured 5% of SE (Typ.)

OPERATING CONDITION

CHARACTERISTIC		SYMBOL	MIN.	TYP.	MAX.	UNIT
Clock Pulse Voltage	"H" Level	$V_{\phi 1E, O}$	4.5	5	5.5	V
	"L" Level	$V_{\phi 2E, O}$	0	—	0.5	
Final Stage Clock Voltage	"H" Level	$V_{\phi 1B}$	4.5	5	5.5	V
	"L" Level	$V_{\phi 2B}$	0	—	0.5	
Shift Pulse Voltage	"H" Level	V_{SH}	4.5	5	5.5	V
	"L" Level		0	—	0.5	
Reset Pulse Voltage	"H" Level	$\overline{V_{RS1}}$	4.5	5	5.5	V
	"L" Level	$\overline{V_{RS2}}$	0	—	0.5	
Clamp Pulse Voltage	"H" Level	$\overline{V_{CP1}}$	4.5	5	5.5	V
	"L" Level	$\overline{V_{CP2}}$	0	—	0.5	
Power Supply Voltage		V_{OD}	11.4	12.0	13.0	V

CLOCK CHARACTERISTICS (Ta = 25°C)

CHARACTERISTIC	SYMBOL	MIN.	TYP.	MAX.	UNIT
Clock Pulse Frequency	f_{ϕ}	—	1	10	MHz
Reset Pulse Frequency	$f_{\overline{RS}}$	—	1	10	MHz
Clock Capacitance	$C_{\phi E}$	—	350	450	pF
	$C_{\phi O}$	—	350	450	
Final Stage Clock Capacitance	$C_{\phi B}$	—	10	20	pF
Shift Gate Capacitance	C_{SH}	—	10	20	pF
Reset Gate Capacitance	$C_{\overline{RS}}$	—	10	20	pF
Clamp Gate Capacitance	$C_{\overline{CP}}$	—	10	20	pF

TIMING CHART

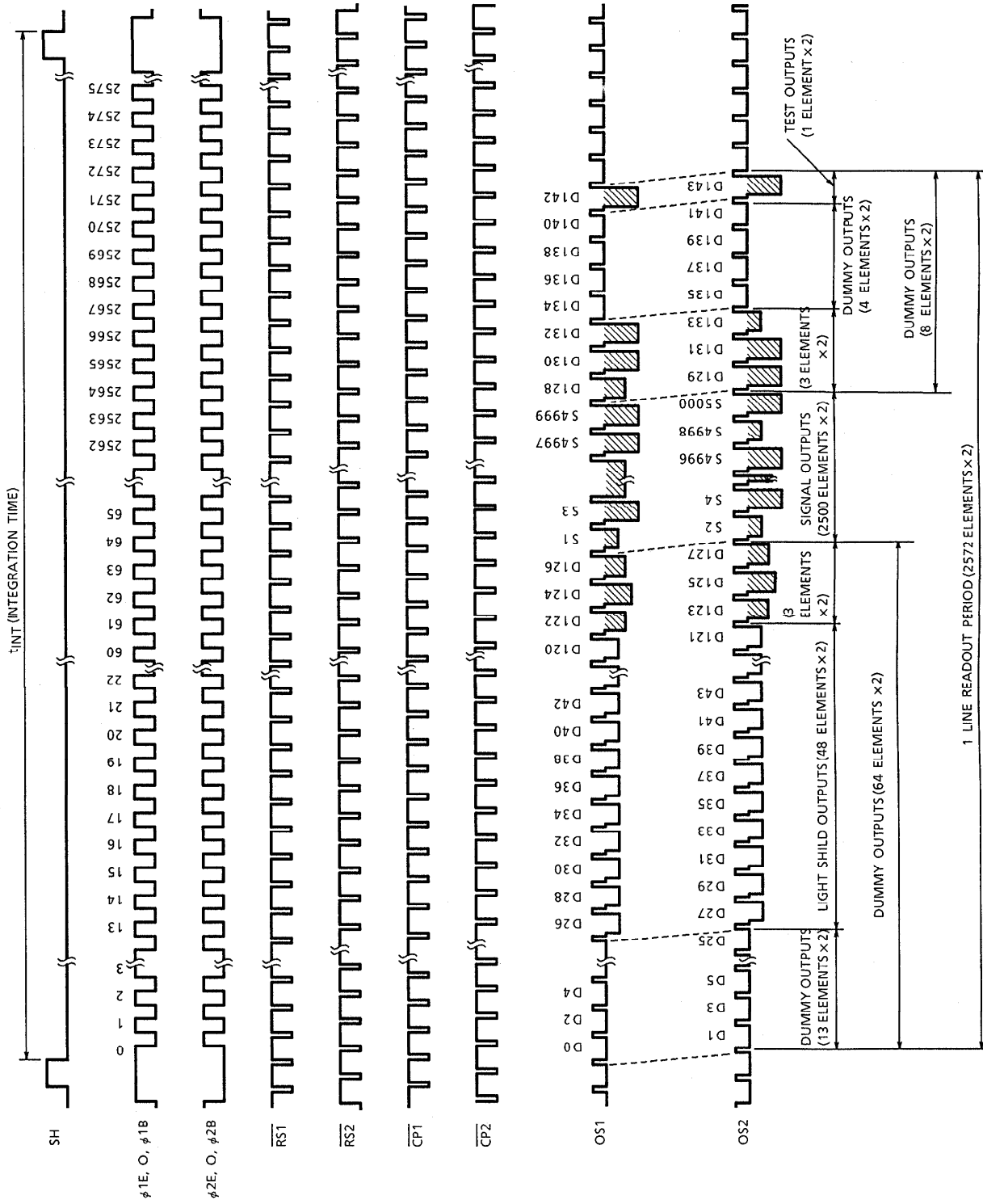

TIMING REQUIREMENTS

SH, $\phi 1$ Timing

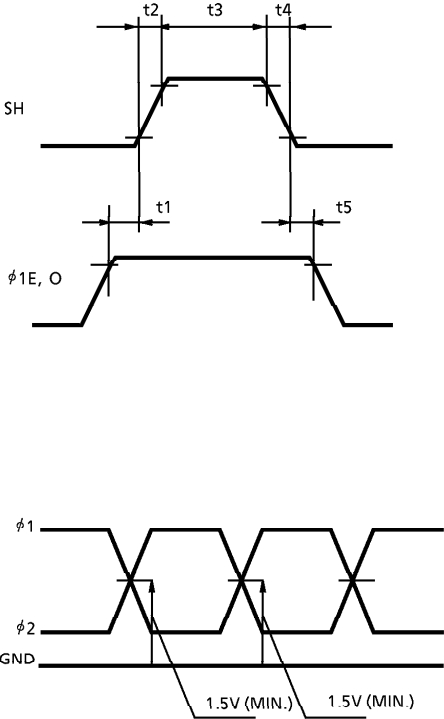

$\phi 1, \phi 2, \overline{RS}, \overline{CP}, OS$ Timing

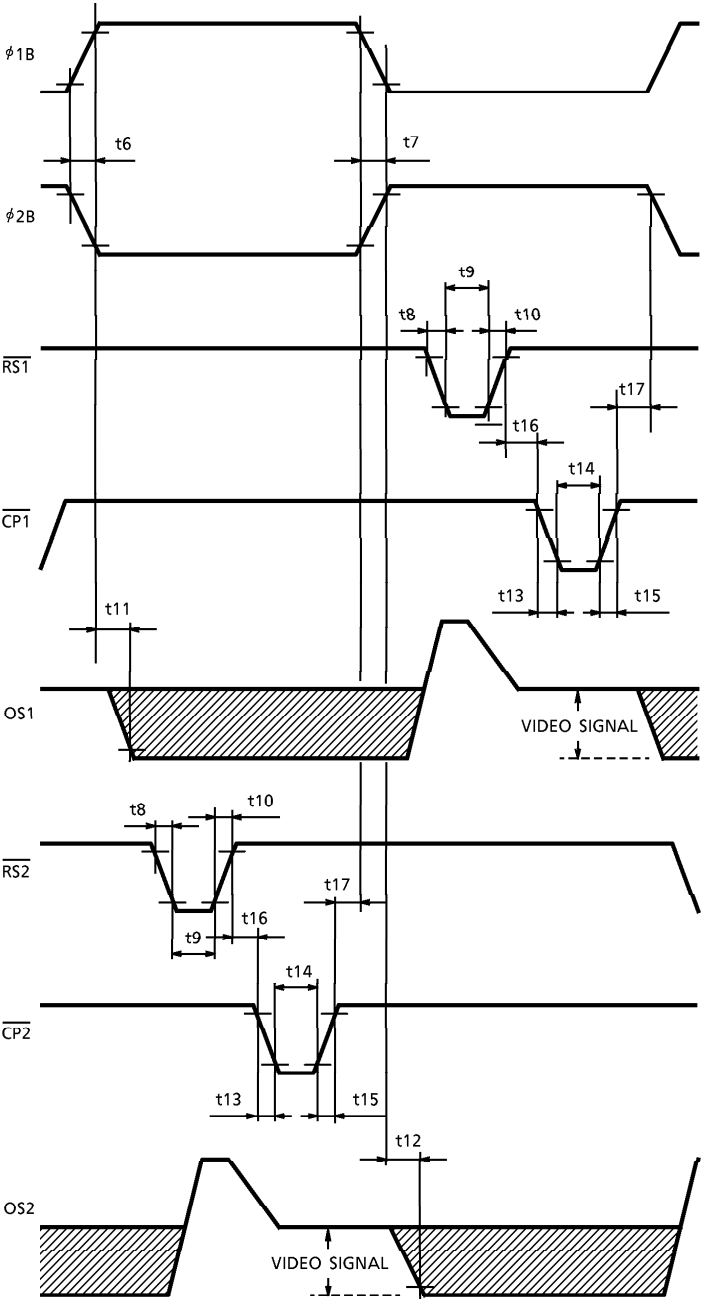

CHARACTERISTIC	SYMBOL	MIN.	TYP. (Note 9)	MAX.	UNIT
Pulse Timing of SH and ϕ 10, E	t1, t5	100	300	—	ns
SH Pulse Rise Time, Fall Time	t2, t4	0	50	—	ns
SH Pulse Width	t3	500	1000	—	ns
ϕ 1, ϕ 2 Pulse Rise Time, Fall Time	t6, t7	0	100	—	ns
\overline{RS} Pulse Rise Time, Fall Time	t8, t10	0	20	—	ns
\overline{RS} Pulse Width	t9	20	250	—	ns
Video Data Delay Time (Note 10)	t11, t12	—	20	—	ns
\overline{CP} Pulse Rise Time, Fall Time	t13, t15	0	20	—	ns
\overline{CP} Pulse Width	t14	20	—	—	ns
Pulse Timing of \overline{RS} and \overline{CP}	t16	0	—	—	ns
Pulse Timing of ϕ 1B, ϕ 2B and \overline{CP}	t17	0	—	—	ns

(Note 9) TYP. is the case of $f_{RS} = 1.0\text{MHz}$

(Note 10) Load Resistance is $100\text{k}\Omega$

TYPICAL PERFORMANCE CURVES

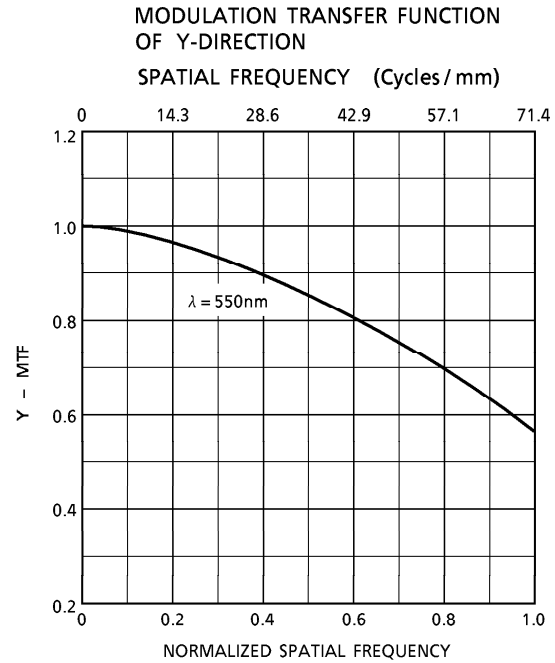
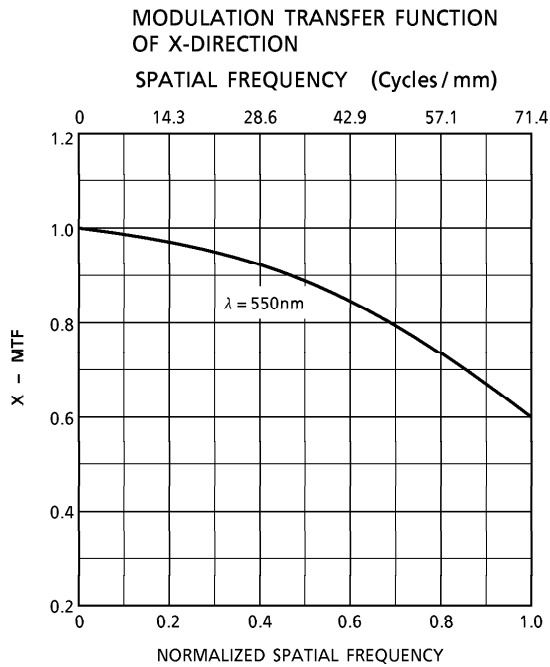
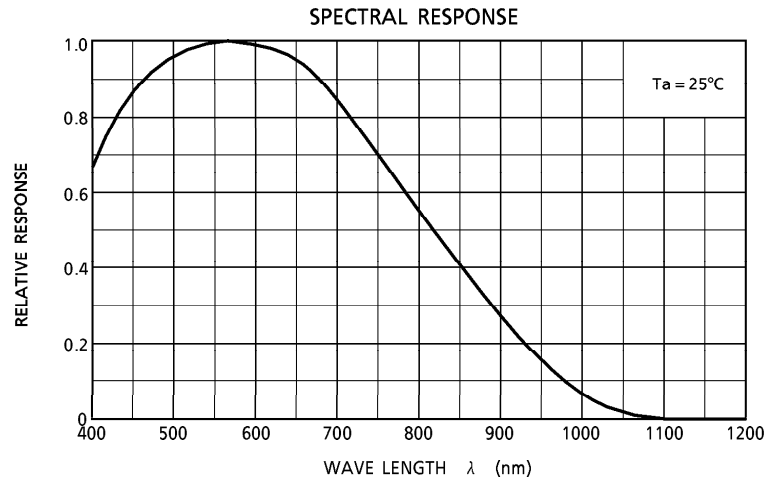

TYPICAL PERFORMANCE CURVES (Cont'd)

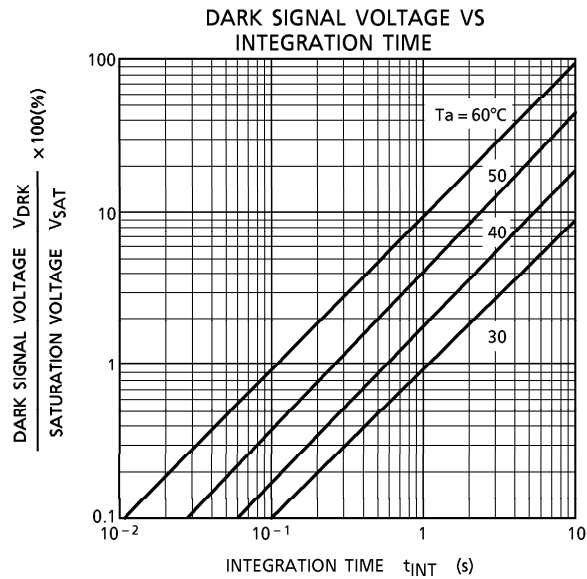
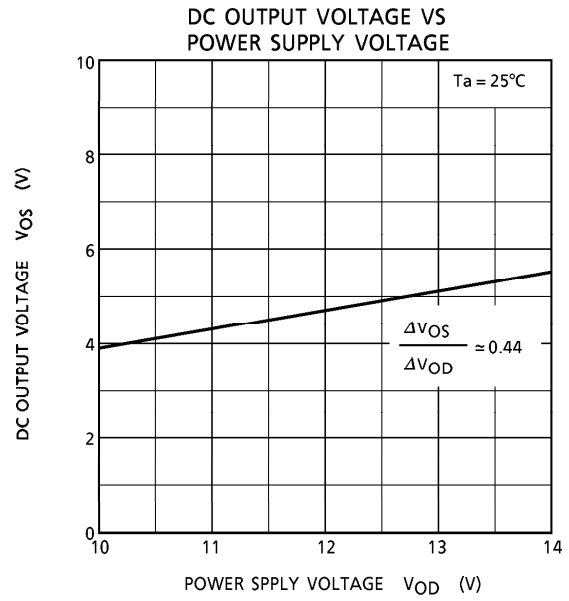
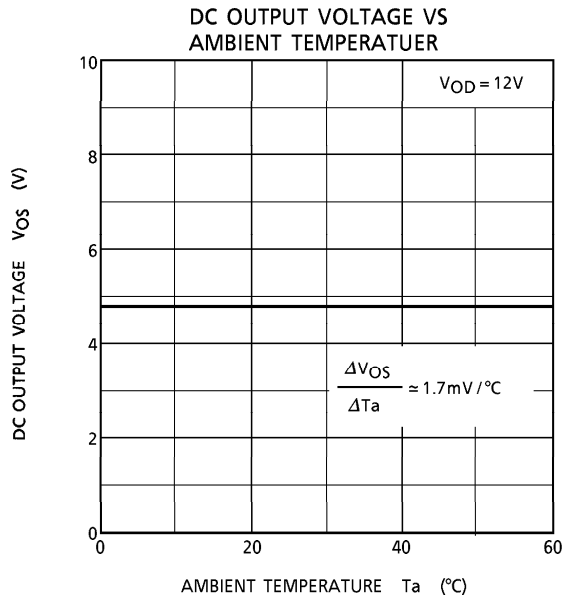

CAUTION

1. Window Glass

The dust and stain on the glass window of the package degrade optical performance of CCD sensor. Keep the glass window clean by saturating a cotton swab in alcohol and lightly wiping the surface, and allow the glass to dry by blowing with filtered dry N₂.

Care should be taken to avoid mechanical or thermal shock because the glass window is easily to damage.

2. Electrostatic Breakdown

Store in shorting clip or in conductive foam to avoid electrostatic breakdown.

3. Incident Light

CCD sensor is sensitive to infrared light.

Note that infrared light component degrades resolution and PRNU of CCD sensor.

PACKAGE OUTLINE

WDIP22-C-400-2.54B (A)

Unit in mm

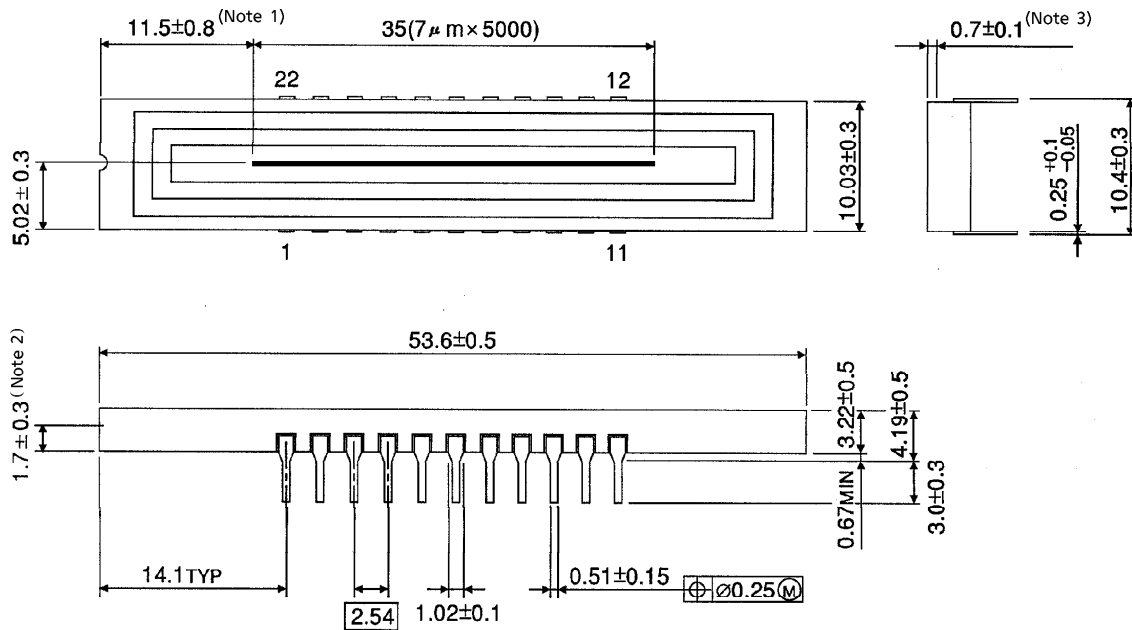

- (Note 1) No. 1 SENSOR ELEMENT (S1) TO EDGE OF PACKAGE.
- (Note 2) TOP OF CHIP TO BOTTOM OF PACKAGE.
- (Note 3) GLASS THICKNES (n = 1.5)

Weight : 5.4g (Typ.)