

TOSHIBA BIPOLAR LINEAR INTEGRATED CIRCUIT SILICON MONOLITHIC

# TA4000F

## VHF~UHF WIDE BAND AMPLIFIER APPLICATIONS

### FEATURES

- Band Width 700MHz (Min.) @3dB down
- Low Noise 4dB (Typ.) @f = 400MHz
- Small Package

### PIN ASSIGNMENT (TOP VIEW)

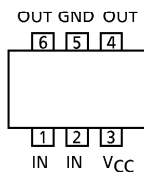

### Marking

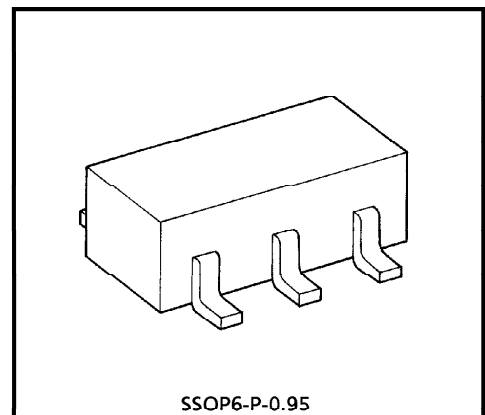
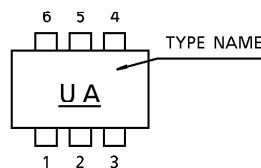

Weight : 0.014g (Typ.)

### MAXIMUM RATINGS (Ta = 25°C)

CHARACTERISTIC	SYMBOL	RATING	UNIT
Supply Voltage	V <sub>CC</sub>	6	V
Total Power Dissipation	P <sub>D</sub> *	300	mW
Operating Temperature	T <sub>opr</sub>	-40~85	°C
Storage Temperature	T <sub>stg</sub>	-55~125	°C

\* When mounted on the glass epoxy board of 2.5cm<sup>2</sup> x 1.6t

### ELECTRICAL CHARACTERISTICS (Ta = 25°C)

CHARACTERISTIC	SYMBOL	TEST CIRCUIT	TEST CONDITION	MIN.	TYP.	MAX.	UNIT
Circuit Current	I <sub>CC</sub>	—	V <sub>CC</sub> = 5V, ZERO Carrier	9	12	15	mA
Gain	S <sub>21</sub>   <sup>2</sup>	1	V <sub>CC</sub> = 5V, f = 400MHz	11	15	18	dB
Noise Figure	NF	1	V <sub>CC</sub> = 5V, f = 400MHz	—	4	7	dB
Band Width	BW	1	V <sub>CC</sub> = 5V (Note)	0.7	1.3	—	GHz
Maximum Output Level	P <sub>o</sub>	1	V <sub>CC</sub> = 5V, f = 400MHz Pin = -10dBmW	-8	-2	—	dBmW

(Note) Frequency of 3dB down to |S<sub>21</sub>|<sup>2</sup> (at f = 400MHz)

961001EBA2

- TOSHIBA is continually working to improve the quality and the reliability of its products. Nevertheless, semiconductor devices in general can malfunction or fail due to their inherent electrical sensitivity and vulnerability to physical stress. It is the responsibility of the buyer, when utilizing TOSHIBA products, to observe standards of safety, and to avoid situations in which a malfunction or failure of a TOSHIBA product could cause loss of human life, bodily injury or damage to property. In developing your designs, please ensure that TOSHIBA products are used within specified operating ranges as set forth in the most recent products specifications. Also, please keep in mind the precautions and conditions set forth in the TOSHIBA Semiconductor Reliability Handbook.
- The products described in this document are subject to foreign exchange and foreign trade control laws.
- The information contained herein is presented only as a guide for the applications of our products. No responsibility is assumed by TOSHIBA CORPORATION for any infringements of intellectual property or other rights of the third parties which may result from its use. No license is granted by implication or otherwise under any intellectual property or other rights of TOSHIBA CORPORATION or others.
- The information contained herein is subject to change without notice.

EQUIVALENT CIRCUIT

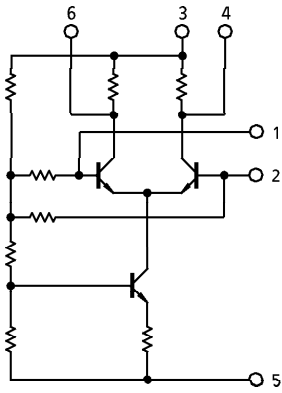

RF MEASURE CIRCUIT 1

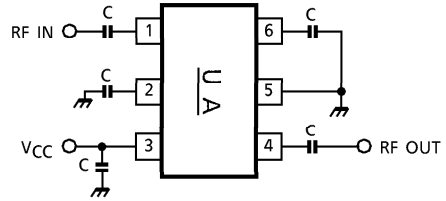

(\*) C : 1000pF & 10000pF

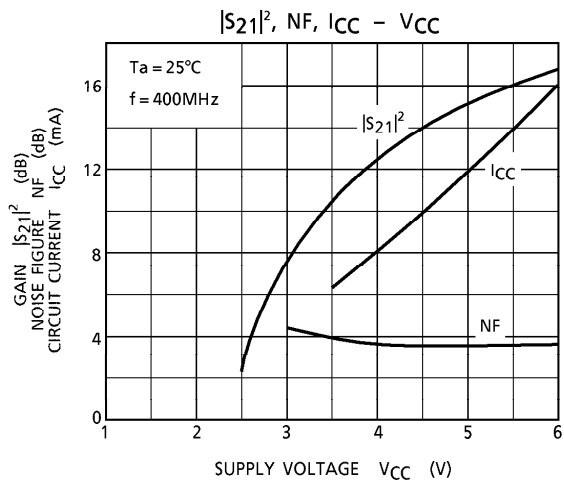
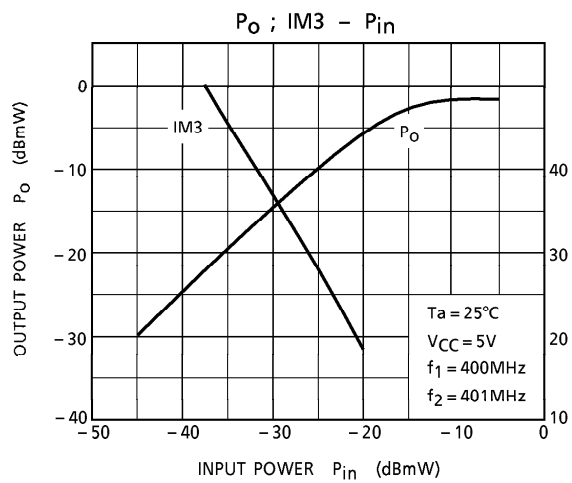
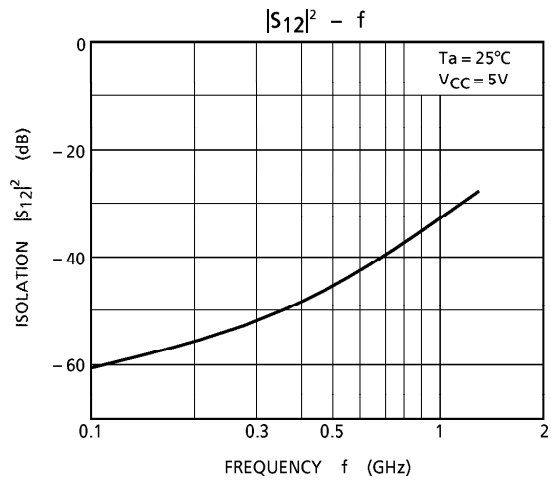
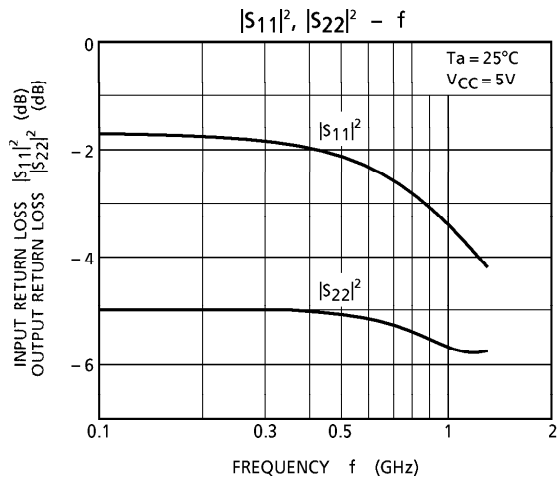
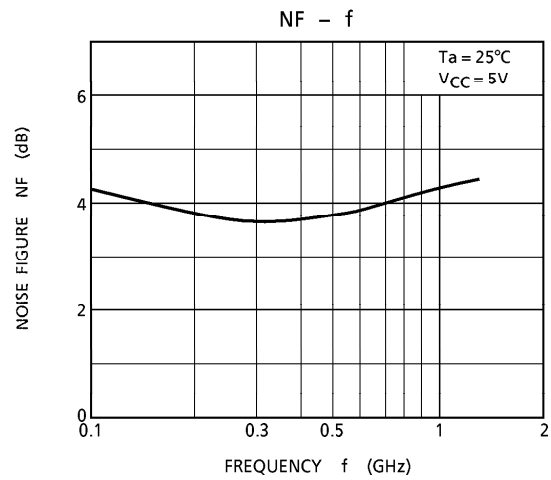
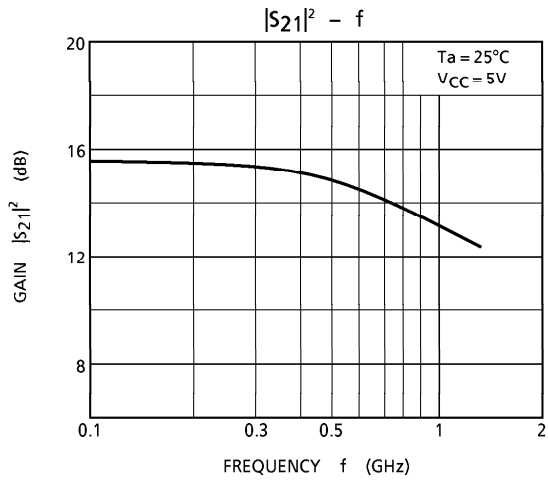

OUTLINE DRAWING  
SSOP6-P-0.95

Unit : mm

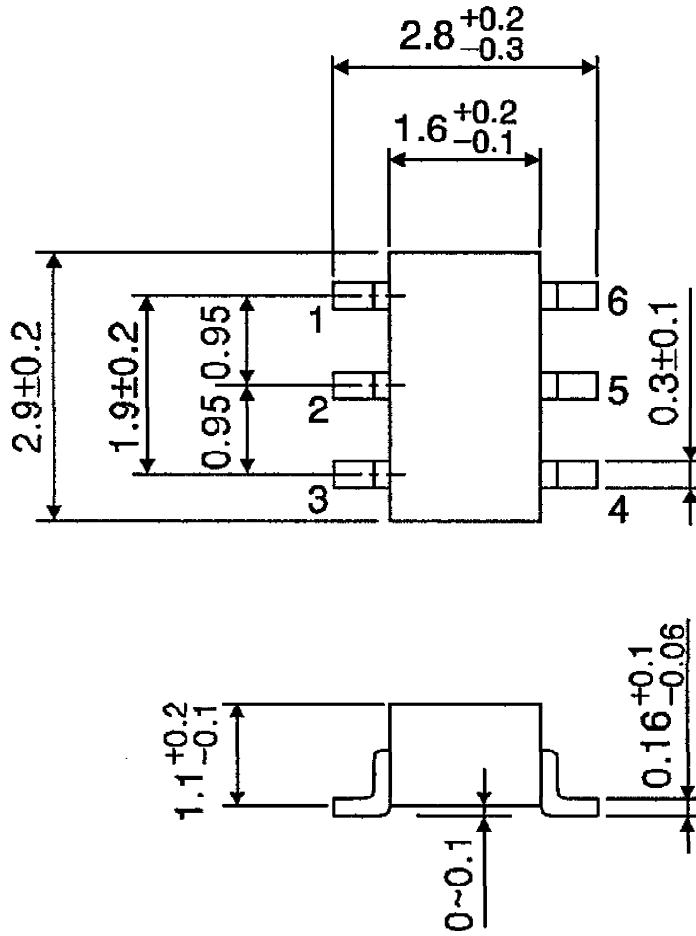

Weight : 0.014g (Typ.)