

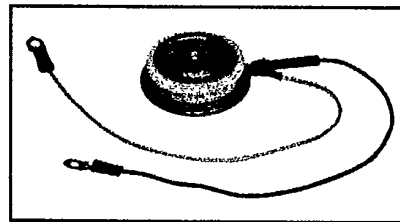

T625

Powerex, Inc. Hillis Street, Youngwood, Pennsylvania 15697 (412) 925-7272
 Powerex Europe, S.A., 428 Ave. G. Durand, BP107, 72003 LeMans, France (43) 72.75.15

Phase Control SCR
 250-400 Amperes Avg
 100-1200 Volts

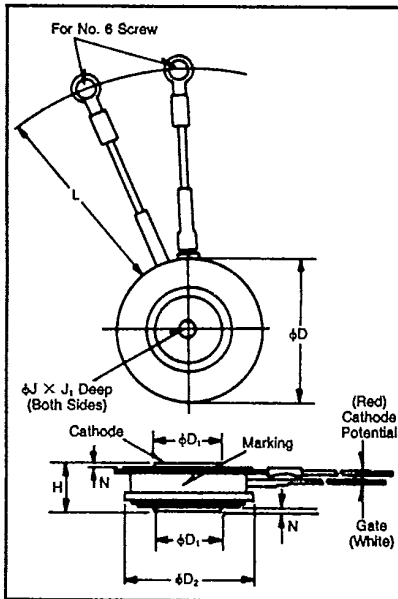

T625
Phase Control SCR
 250-400 Amperes/100-1200 Volts

Description

Powerex Silicon Controlled Rectifiers (SCR) are designed for phase control applications. These are all-diffused, Press-Pak (Pow-R-Disc) devices employing the field-proven amplifying (di/namic) gate.

Features:

- Low On-State Voltage
- High di/dt
- High dv/dt
- Hermetic Packaging
- Excellent Surge and I²t Ratings
- 150°C Junction Temperature Rating

Applications:

- Power Supplies
- Battery Chargers
- Motor Control
- Light Dimmers
- VAR Generators

Ordering Information

Example: Select the complete eight digit part number you desire from the table - i.e. T6250625 is a 600 Volt, 250 Ampere Phase Control SCR.

T62
Outline Drawing

Dimensions	Inches		Millimeters	
	Min.	Max.	Min.	Max.
φD	1.610	1.650	40.89	41.91
φD ₁	.745	.755	18.92	19.18
φD ₂	1.420	1.460	36.07	37.08
H	.500	.560	12.70	14.22
φJ	.135	.145	3.43	3.68
J ₁	.072	.082	1.83	2.08
L	7.75	8.50	196.85	215.90
N	.030	—	.76	—

Creep Distance—34 in. min. (8.64 mm)
 Strike Distance—26 in. min. (6.60 mm).
 (In accordance with NEMA standards.)
 Finish—Nickel Plate.
 Approx. Weight—2.3 oz. (66 g).
 1. Dimension "H" is clamped dimension.

Type	Voltage		Current	
	V _{ORM} V _{RRM}	Code	I _T (avg)	Code
T625	100	01	250	25
	200	02	300	30
	300	03	400	40
	400	04		
	500	05		
	600	06		
	700	07		
	800	08		
	900	09		
	1000	10		
	1100	11		
	1200	12		



Powerex, Inc., Hillis Street, Youngwood, Pennsylvania 15697 (412) 925-7272
 Powerex Europe, S.A., 428 Ave. G. Durand, BP107, 72003 LeMans, France (43) 72.75.15

T625
Phase Control SCR
 250-400 Amperes Avg/100-1200 Volts

Absolute Maximum Ratings

	Symbol	T625 _ _ 25	T625 _ _ 30	T625 _ _ 40	Units
RMS On-State Current	$I_{T(RMS)}$	390	470	625	Amperes
Average On-State Current	$I_{T(av)}$	250	300	400	Amperes
Peak One-Cycle Surge (Non-Repetitive) On-State Current (60Hz) ^①	I_{TSM}	2800	3600	5000	Amperes
Peak One-Cycle Surge (Non-Repetitive) On-State Current (50Hz) ^①	I_{TSM}	2550	3300	4550	Amperes
Critical Rate-of-Rise of On-State Current (Non-Repetitive) ^{① ②}	di/dt	800	800	800	Amperes/μs
Critical Rate-of-Rise of On-State Current (Repetitive)	di/dt	200	200	200	Amperes/μs
I^2t (for Fusing), 8.3 milliseconds	I^2t	32,500	54,000	100,000	A ² sec
Peak Gate Power Dissipation	P_{GM}	16	16	16	Watts
Average Gate Power Dissipation	$P_{G(av)}$	3	3	3	Watts
Storage Temperature	T_{STG}	-40 to 150	-40 to 150	-40 to 150	°C
Operating Temperature	T_J	-40 to 150	-40 to 150	-40 to 150	°C
Mounting Force ^③		1000 to 1400	1000 to 1400	1000 to 1400	lb.
Mounting Force ^④		450 to 635	450 to 635	450 to 635	kg

① Consult recommended mounting procedures.

② Applies for zero or negative gate bias.

③ Per JEDEC RS-397, 5.2.2.1.

④ With recommended gate drive.

⑤ Higher dv/dt ratings available, consult factory.

⑥ Per JEDEC standard RS-397, 5.2.2.6.



Powerex, Inc., Hillis Street, Youngwood, Pennsylvania 15697 (412) 925-7272
 Powerex Europe, S.A., 428 Ave. G. Durand, BP107, 72003 LeMans, France (43) 72.75.15

T625
Phase Control SCR
 250-400 Amperes Avg/100-1200 Volts

Electrical and Thermal Characteristics

	Symbol	Test Conditions	T625 _ _ 25	T625 _ _ 30	T625 _ _ 40	Units
Current—Conducting State Maximums						
Peak On-State Voltage	V_{TM}	$I_{TM} = 625A, T_J = 25^\circ C$	2.60	2.05	1.55	Volts
T625						
Voltage—Blocking State Maximums^①						
Forward Leakage, Peak	I_{DRM}	$T_J = 150^\circ C, V_{DRM} = \text{rated}$		50		mA
Reverse Leakage, Peak	I_{RRM}	$T_J = 150^\circ C, V_{RRM} = \text{rated}$		50		mA
Switching						
Typical Turn-Off Time	t_q	$I_T = 150A, T_J = 150^\circ C,$ $di_T/dt = 12.5A/\mu\text{sec, reapplied}$ $dv/dt = 20V/\mu\text{sec linear to } 0.8V_{DRM}$		150		μsec
Typical Turn-On Time ^②	t_{on}	$I_T = 100A, V_D = 500V$		3		μsec
Min. Critical dv/dt exponential to V_{DRM} ^③	dv/dt	$T_J = 150^\circ C$		300		$V/\mu\text{sec}$
Thermal						
Maximum Thermal Resistance, double sided cooling ^④						
Junction to Case	$R_{\theta JC}$.08		$^\circ C/\text{Watt}$
Case to Sink, Lubricated	$R_{\theta CS}$.02		$^\circ C/\text{Watt}$
Gate—Maximum Parameters						
Gate Current to Trigger	I_{GT}	$T_J = 25^\circ C, V_D = 12V$		150		mA
Gate Voltage to Trigger	V_{GT}	$T_J = 25^\circ C, V_D = 12V$		3		Volts
Non-Triggering Gate Voltage	V_{GDM}	$T_J = 150^\circ C, \text{rated } V_{DRM}$.25		Volts
Peak Forward Gate Current	I_{GTM}			4		Amperes
Peak Reverse Gate Voltage	V_{GRM}			5		Volts

- ① Consult recommended mounting procedures.
 ② Applies for zero or negative gate bias.
 ③ Per JEDEC RS-397, 5.2.2.1.
 ④ With recommended gate drive.
 ⑤ Higher dv/dt ratings available, consult factory.
 ⑥ Per JEDEC standard RS-397, 5.2.2.6.



Powerex, Inc., Hillis Street, Youngwood, Pennsylvania 15697 (412) 925-7272
 Powerex Europe, S.A., 428 Ave. G. Durand, BP107, 72003 LeMans, France (43) 72.75.15

T625
 Phase Control SCR
 250-400 Amperes Avg/100-1200 Volts

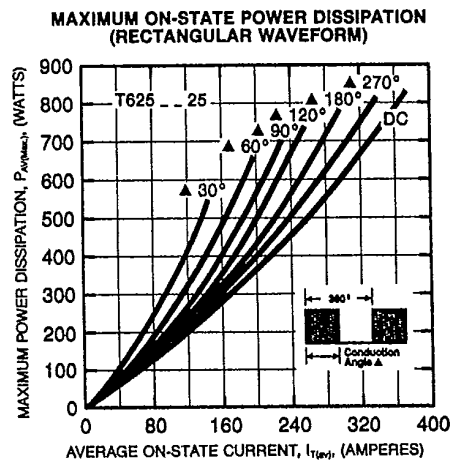
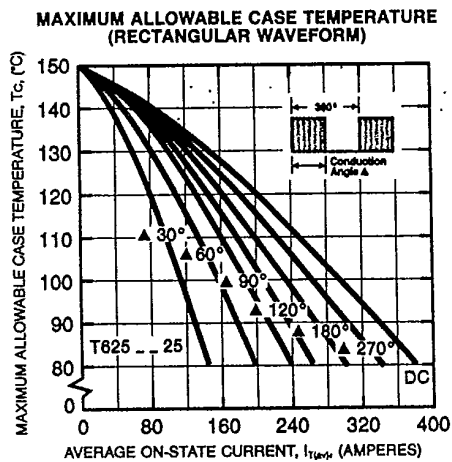
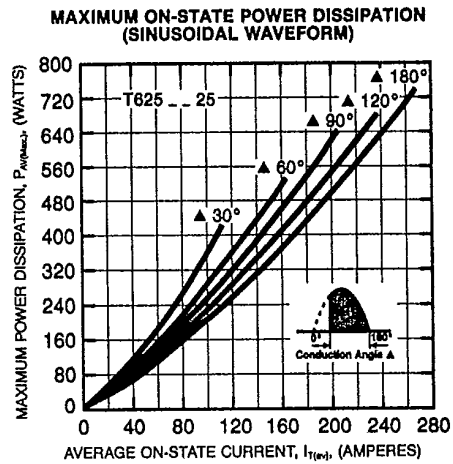
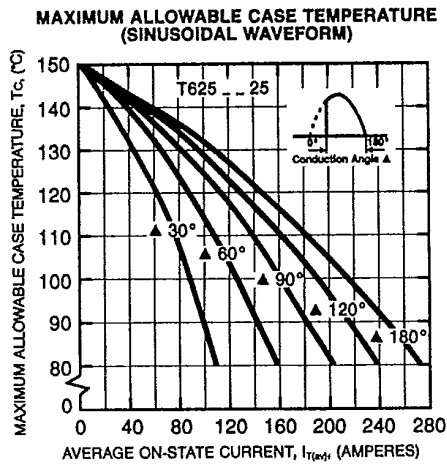
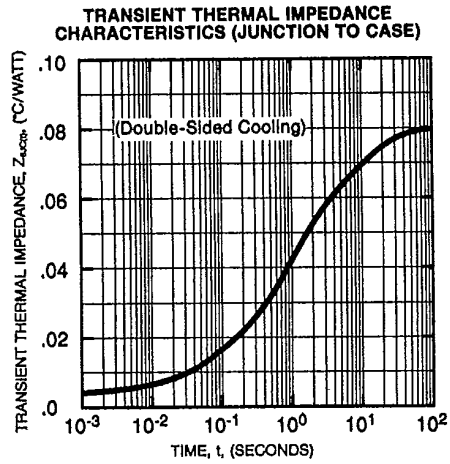
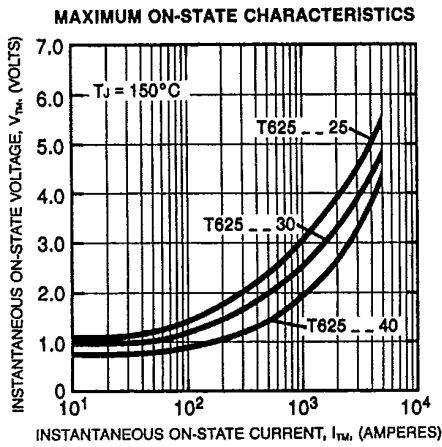



Powerex, Inc., Hillis Street, Youngwood, Pennsylvania 15697 (412) 925-7272
 Powerex Europe, S.A., 428 Ave. G. Durand, BP107, 72003 LeMans, France (43) 72.75.15

T625
 Phase Control SCR
 250-400 Amperes Avg/100-1200 Volts

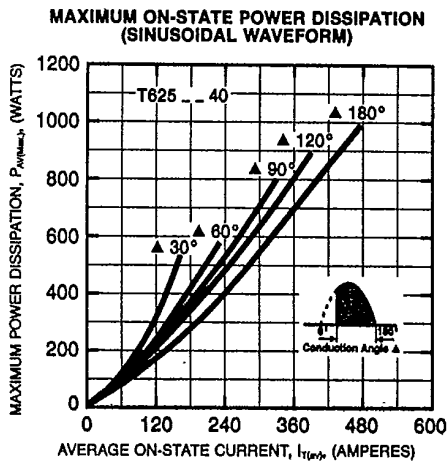
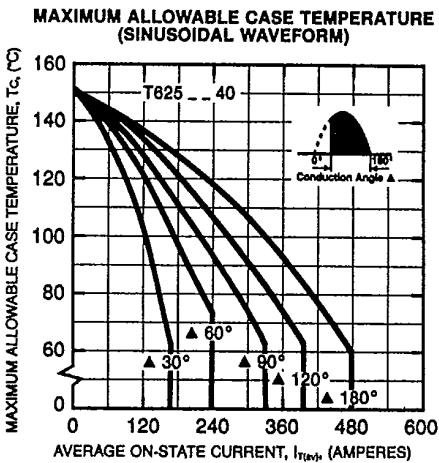
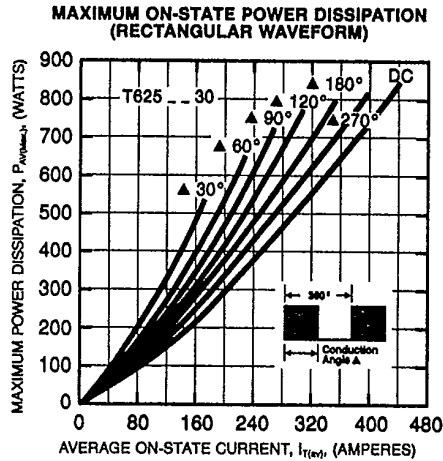
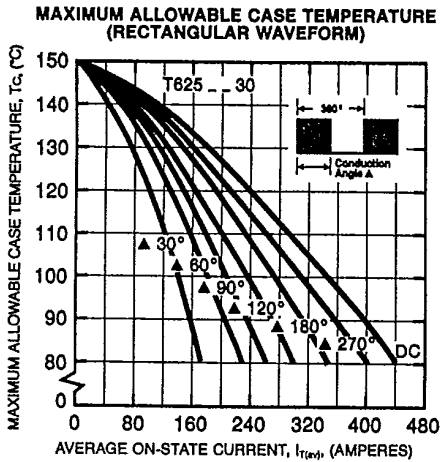
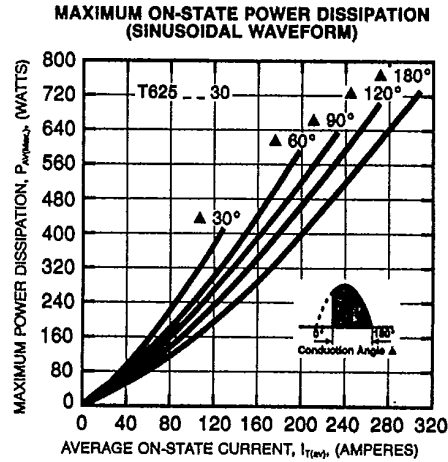
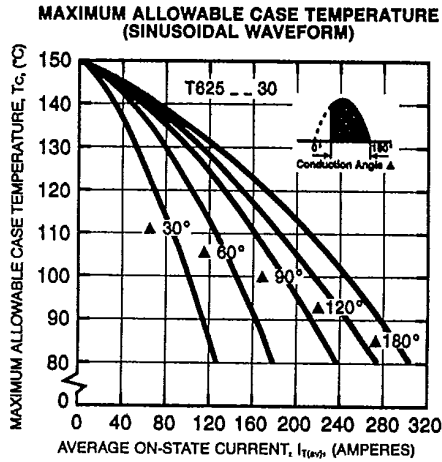



Powerex, Inc., Hillis Street, Youngwood, Pennsylvania 15697 (412) 925-7272
 Powerex Europe, S.A., 428 Ave. G. Durand, BP107, 72003 LeMans, France (43) 72.75.15

T625
 Phase Control SCR
 250-400 Amperes Avg/100-1200 Volts

