

ANSALDO**Ansaldo Trasporti s.p.a.
Unita' Semiconduttori**Via N. Lorenzi 8 - I 16152 GENOVA - ITALY
Tel. int. +39/(0)10 6556549 - (0)10 6556488
Fax Int. +39/(0)10 6442510
Tx 270318 ANSUSE I -**PHASE CONTROL THYRISTOR****AT738**

Repetitive voltage up to	2200 V
Mean on-state current	3670 A
Surge current	60 kA

FINAL SPECIFICATION

feb 97 - ISSUE : 02

Symbol	Characteristic	Conditions	T _j [°C]	Value	Unit
BLOCKING					
V _{RRM}	Repetitive peak reverse voltage		125	2200	V
V _{RSM}	Non-repetitive peak reverse voltage		125	2300	V
V _{DRM}	Repetitive peak off-state voltage		125	2200	V
I _{RRM}	Repetitive peak reverse current	V=V _{RRM}	125	200	mA
I _{DRM}	Repetitive peak off-state current	V=V _{DRM}	125	200	mA
CONDUCTING					
I _{T(AV)}	Mean on-state current	180° sin, 50 Hz, Th=55°C, double side cooled		3670	A
I _{T(AV)}	Mean on-state current	180° sin, 50 Hz, Tc=85°C, double side cooled		2860	A
I _{TSM}	Surge on-state current	sine wave, 10 ms	125	60	kA
I ² t	I ² t	without reverse voltage		18000 x1E3	A ² s
V _T	On-state voltage	On-state current = 2000 A	25	1.1	V
V _{T(TO)}	Threshold voltage		125	0.92	V
r _T	On-state slope resistance		125	0.090	mohm
SWITCHING					
di/dt	Critical rate of rise of on-state current, min.	From 75% V _{DRM} up to 3000 A, gate 10V 5ohm	125	200	A/μs
dv/dt	Critical rate of rise of off-state voltage, min.	Linear ramp up to 75% of V _{DRM}	125	500	V/μs
t _d	Gate controlled delay time, typical	V _D =100V, gate source 25V, 10 ohm, tr=.5 μs	25	3	μs
t _q	Circuit commutated turn-off time, typical	dV/dt = 20 V/μs linear up to 80% V _{DRM}		320	μs
Q _{rr}	Reverse recovery charge	di/dt=-20 A/μs, I= 2000 A	125		μC
I _{rr}	Peak reverse recovery current	VR= 50 V			A
I _H	Holding current, typical	V _D =5V, gate open circuit	25	300	mA
I _L	Latching current, typical	V _D =5V, tp=30μs	25	700	mA
GATE					
V _{GT}	Gate trigger voltage	V _D =5V	25	3.5	V
I _{GT}	Gate trigger current	V _D =5V	25	350	mA
V _{GD}	Non-trigger gate voltage, min.	V _D =V _{DRM}	125	0.25	V
V _{FGM}	Peak gate voltage (forward)			30	V
I _{FGM}	Peak gate current			10	A
V _{RGM}	Peak gate voltage (reverse)			5	V
P _{GM}	Peak gate power dissipation	Pulse width 100 μs		150	W
P _G	Average gate power dissipation			2	W
MOUNTING					
R _{th(j-h)}	Thermal impedance, DC	Junction to heatsink, double side cooled		11	°C/kW
R _{th(c-h)}	Thermal impedance	Case to heatsink, double side cooled		2	°C/kW
T _j	Operating junction temperature			-30 / 125	°C
F	Mounting force			40.0 / 50.0	kN
	Mass			1700	g
ORDERING INFORMATION : AT738 S 22					
standard specification <input type="checkbox"/> VDRM&VRRM/100 <input type="checkbox"/>					

DISSIPATION CHARACTERISTICS

SQUARE WAVE

Th [°C]

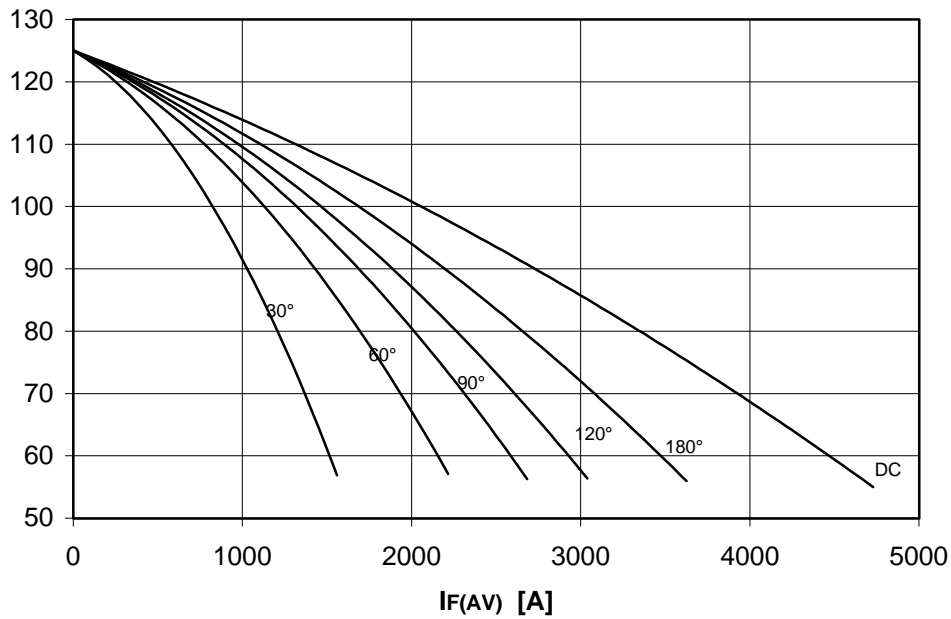

PF(AV) [W]

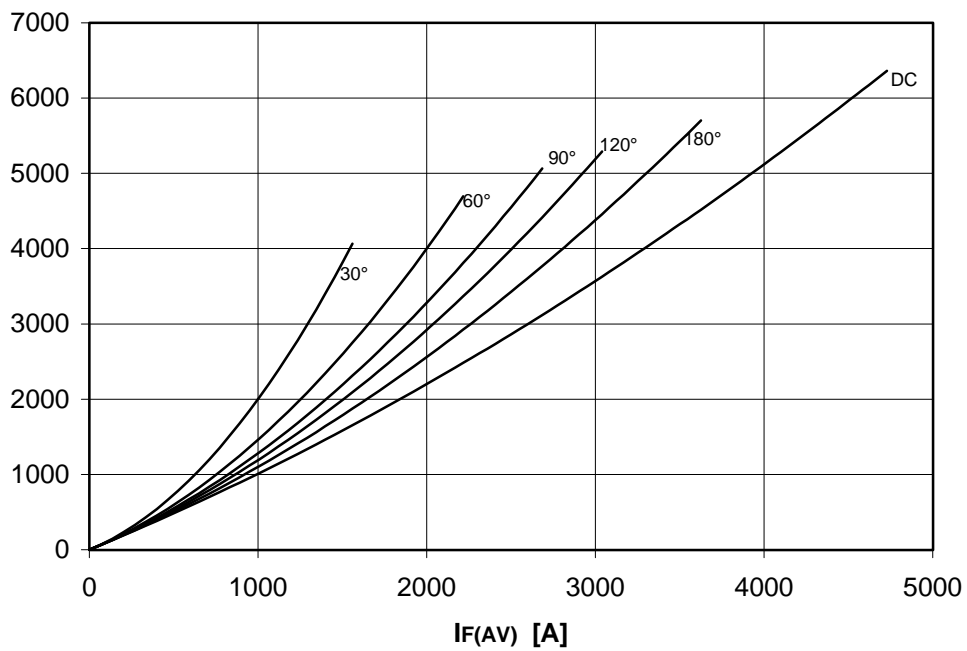

DISSIPATION CHARACTERISTICS

SINE WAVE

Th [°C]

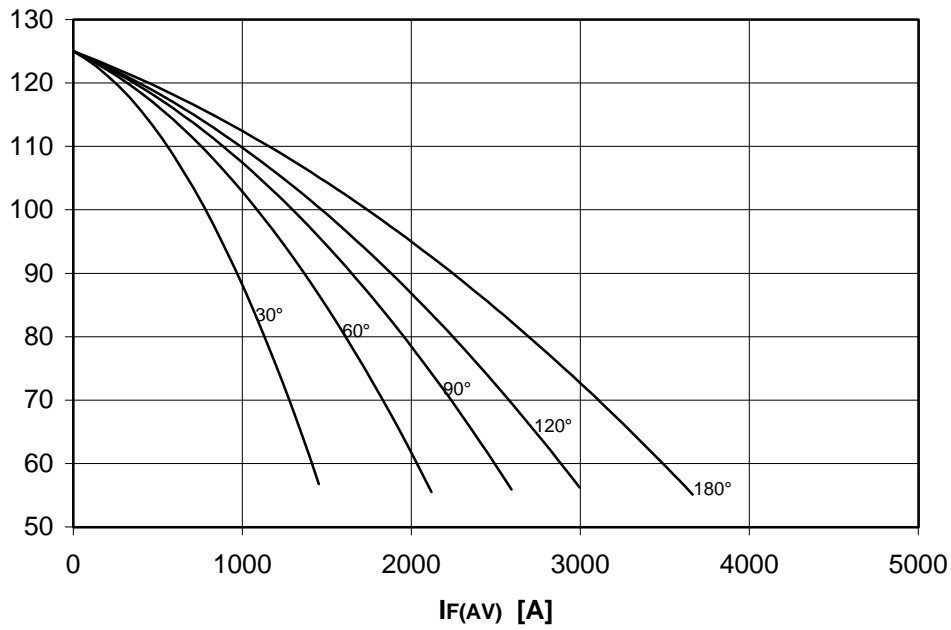

PF(AV) [W]

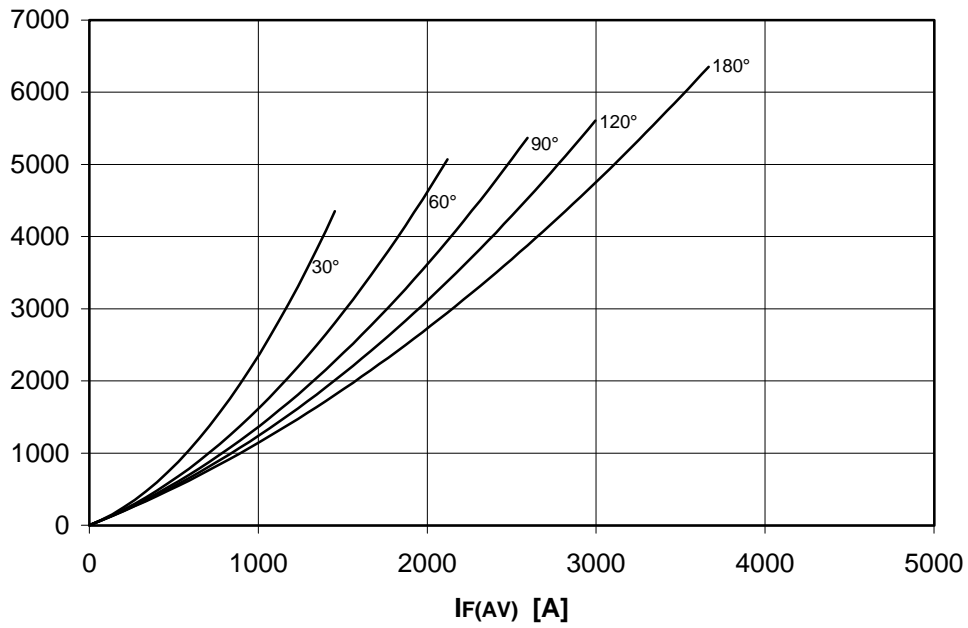

AT738 PHASE CONTROL THYRISTOR

ANSALDO

FINAL SPECIFICATION feb 97 - ISSUE : 02

ON-STATE CHARACTERISTIC
T_j = 125 °C

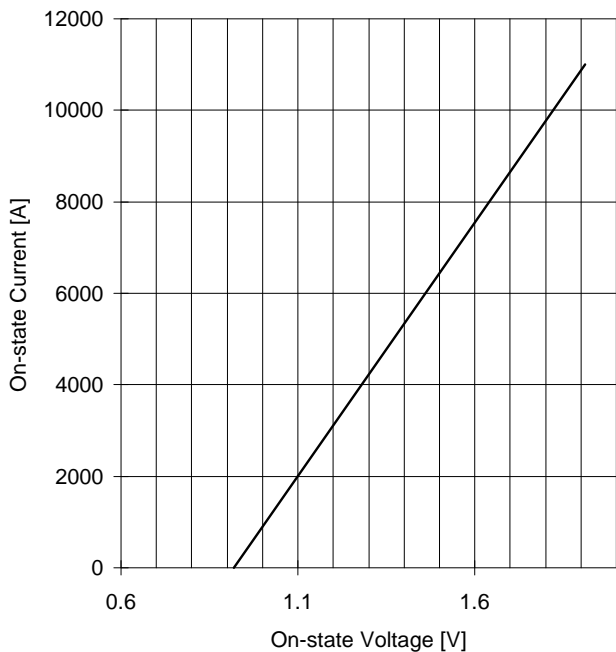

SURGE CHARACTERISTIC
T_j = 125 °C

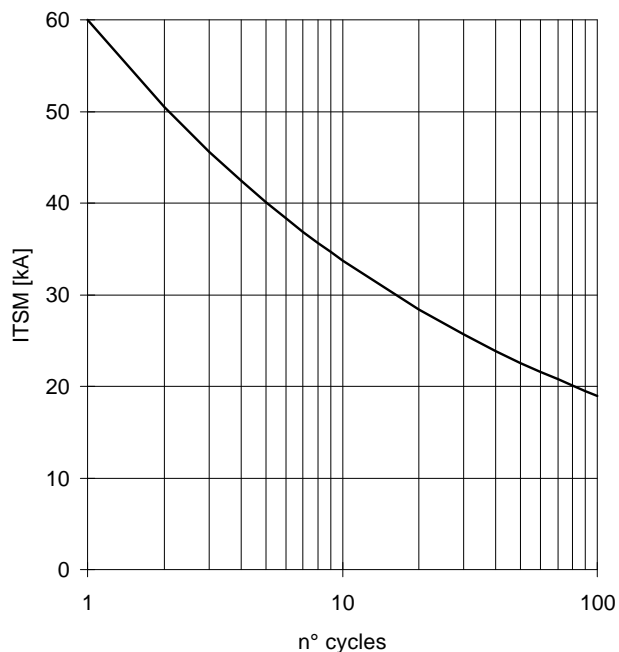

TRANSIENT THERMAL IMPEDANCE
DOUBLE SIDE COOLED

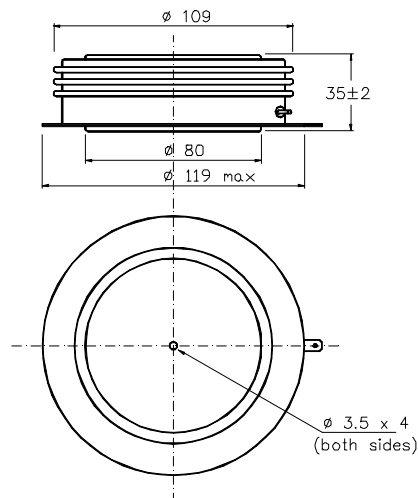
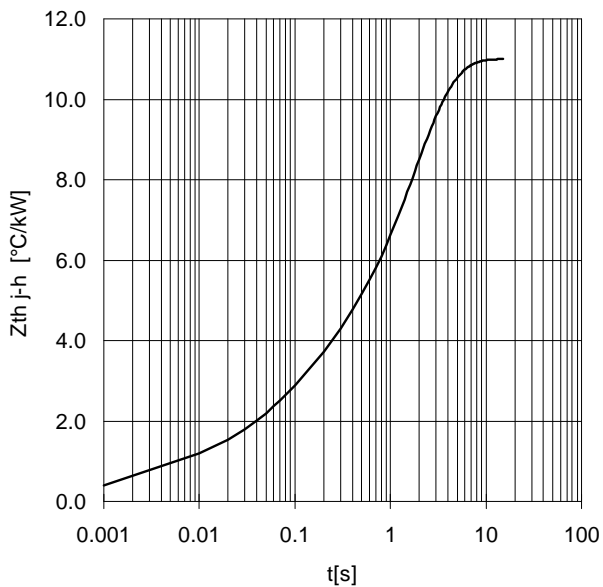

Dimensions
in mm



Cathode terminal type DIN 46244 - A 4.8 - 0.8

Gate terminal type AMP 60598 - 1

All the characteristics given in this data sheet are guaranteed only with uniform clamping force, cleaned and lubricated heatsink, surfaces with flatness < .03 mm and roughness < 2 μm .

In the interest of product improvement ANSALDO reserves the right to change any data given in this data sheet at any time without previous notice.

If not stated otherwise the maximum value of ratings (symbols over shaded background) and characteristics is reported.

Distributed by

