

2 x 1W Stereo audio power amplifier with active low standby mode

- Operating from $V_{CC}=2.2V$ to 5.5V
- 1W output power per channel @ $V_{CC}=5V$, THD+N=1%, $R_L=8\Omega$
- 10nA standby current
- 62dB PSRR @ 217Hz with grounded inputs
- High SNR: 100dB(A) typ.
- Near-zero pop & click
- Available in QFN16 4x4 mm, 0.5mm pitch, leadfree package

Description

The TS4984 has been designed for top of the class stereo audio applications. Thanks to its compact and power dissipation efficient QFN package, it suits various applications.

With a BTL configuration, this Audio Power Amplifier is capable of delivering 1W per channel of continuous RMS output power into an 8Ω load @ 5V.

An externally controlled standby mode control reduces the supply current to less than 10nA per channel. The device also features an internal thermal shutdown protection.

The gain of each channel can be configured by external gain setting resistors.

Applications

- Cellular mobile phones
- Notebook computers & PDAs
- LCD monitors & TVs
- Portable audio devices

Order Codes

Part Number	Temperature Range	Package	Packaging	Marking
TS4984IQT	-40, +85°C	QFN	Tape & Reel	K984

Pin Connections (top view)

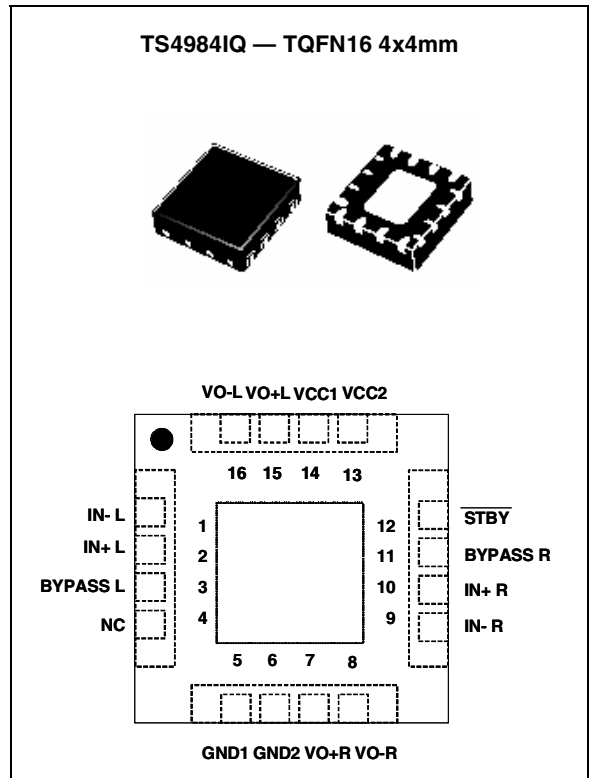

1 Typical Application

Figure 1 shows a schematic view of a typical audio amplification application using the TS4984. Table 1 describes the components used in this typical application.

Figure 1: Typical application schematic

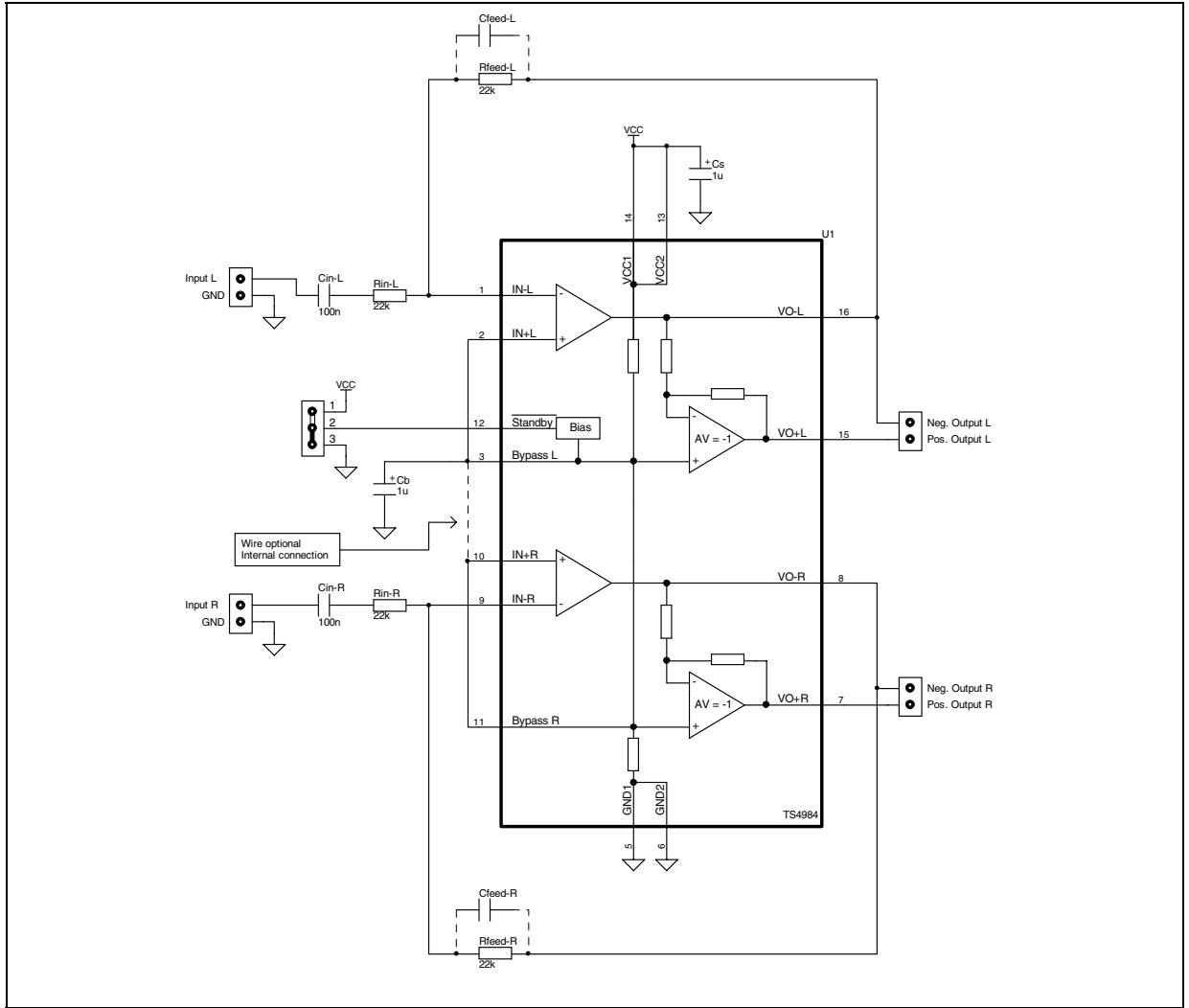

Table 1: External component descriptions

Components	Functional Description
$R_{IN,L,R}$	Inverting input resistors which sets the closed loop gain in conjunction with R_{FEED} . These resistors also form a high pass filter with C_{IN} ($f_c = 1 / (2 \times \pi \times R_{IN} \times C_{IN})$).
$C_{IN,L,R}$	Input coupling capacitors which blocks the DC voltage at the amplifier input terminal.
$R_{FEED,L,R}$	Feedback resistors which sets the closed loop gain in conjunction with R_{IN} .
C_S	Supply Bypass capacitor which provides power supply filtering.
C_B	Bypass pin capacitor which provides half supply filtering.
$A_{V,L,R}$	Closed loop gain in BTL configuration = $2 \times (R_{FEED} / R_{IN})$ on each channel.

2 Absolute maximum ratings and operating conditions

Table 2: Key parameters and their absolute maximum ratings

Symbol	Parameter	Value	Unit
V_{CC}	Supply voltage ¹	6	V
V_i	Input Voltage ²	GND to V_{CC}	V
T_{oper}	Operating Free Air Temperature Range	-40 to + 85	°C
T_{stg}	Storage Temperature	-65 to +150	°C
T_j	Maximum Junction Temperature	150	°C
R_{thja}	Thermal Resistance Junction to Ambient QFN16	120	°C/W
P_d	Power Dissipation	Internally Limited	
ESD	Human Body Model ³	2	kV
ESD	Machine Model	200	V
	Latch-up Immunity	200mA	

- 1) All voltages values are measured with respect to the ground pin
- 2) The magnitude of input signal must never exceed $V_{CC} + 0.3V$ / $GND - 0.3V$
- 3) The voltage value is measured with respect from pin to supply

Table 3: Operating conditions

Symbol	Parameter	Value	Unit
V_{CC}	Supply Voltage	2.2 to 5.5	V
V_{ICM}	Common Mode Input Voltage Range	1.2V to V_{CC}	V
V_{STB}	Standby Voltage Input: Device ON Device OFF	$1.35 \leq V_{STB} \leq V_{CC}$ $GND \leq V_{STB} \leq 0.4$	V
R_L	Load Resistor	≥ 4	Ω
R_{OUTGND}	Resistor Output to GND ($V_{STB} = GND$)	≥ 1	M Ω
T_{SD}	Thermal Shutdown Temperature	150	°C
R_{THJA}	Thermal Resistance Junction to Ambient QFN16 ¹ QFN16 ²	45 85	°C/W

- 1) When mounted on a 4-layer PCB with via
- 2) When mounted on a 2 layer PCB

3 Electrical characteristics

Table 4: Electrical characteristics for $V_{CC} = +5V$, $GND = 0V$, $T_{amb} = 25^{\circ}C$ (unless otherwise specified)

Symbol	Parameter	Min.	Typ.	Max.	Unit
I_{CC}	Supply Current No input signal, no load		7.4	12	mA
$I_{STANDBY}$	Standby Current ¹ No input signal, $V_{stdby} = G_{ND}$, $R_L = 8\Omega$		10	1000	nA
V_{OO}	Output Offset Voltage No input signal, $R_L = 8\Omega$		1	10	mV
P_{out}	Output Power THD = 1% Max, $F = 1kHz$, $R_L = 8\Omega$	0.8	1		W
THD + N	Total Harmonic Distortion + Noise $P_o = 1W_{rms}$, $A_v = 2$, $20Hz \leq F \leq 20kHz$, $R_L = 8\Omega$		0.2		%
PSRR	Power Supply Rejection Ratio ² $R_L = 8\Omega$, $A_v = 2$, $V_{ripple} = 200mV_{pp}$, Input Grounded $F = 217Hz$ $F = 1kHz$	55 55	62 64		dB
Crosstalk	Channel Separation, $R_L = 8\Omega$ $F = 1kHz$ $F = 20Hz$ to $20kHz$		-92 -70		dB
T_{WU}	Wake-Up Time ($C_b = 1\mu F$)		90	130	ms
T_{STDB}	Standby Time ($C_b = 1\mu F$)		10		μs
V_{STDBH}	Standby Voltage Level High			1.3	V
V_{STDBL}	Standby Voltage Level Low			0.4	V
Φ_M	Phase Margin at Unity Gain $R_L = 8\Omega$, $C_L = 500pF$		65		Degrees
GM	Gain Margin $R_L = 8\Omega$, $C_L = 500pF$		15		dB
GBP	Gain Bandwidth Product $R_L = 8\Omega$		1.5		MHz

1) Standby mode is activated when V_{stdby} is tied to Gnd .

2) All PSRR data limits are guaranteed by production sampling tests
Dynamic measurements - $20 \cdot \log(rms(V_{out})/rms(V_{ripple}))$. V_{ripple} is the sinusoidal signal superimposed upon V_{cc} .

Table 5: Electrical characteristics for $V_{CC} = +3.3V$, $GND = 0V$, $T_{amb} = 25^{\circ}C$ (unless otherwise specified)

Symbol	Parameter	Min.	Typ.	Max.	Unit
I_{CC}	Supply Current No input signal, no load		6.6	12	mA
$I_{STANDBY}$	Standby Current ¹ No input signal, $V_{stdby} = G_{ND}$, $R_L = 8\Omega$		10	1000	nA
V_{OO}	Output Offset Voltage No input signal, $R_L = 8\Omega$		1	10	mV
P_{out}	Output Power THD = 1% Max, $F = 1kHz$, $R_L = 8\Omega$	300	450		mW
THD + N	Total Harmonic Distortion + Noise $P_o = 400mWrms$, $A_v = 2$, $20Hz \leq F \leq 20kHz$, $R_L = 8\Omega$		0.1		%
PSRR	Power Supply Rejection Ratio ² $R_L = 8\Omega$, $A_v = 2$, $V_{ripple} = 200mVpp$, Input Grounded $F = 217Hz$ $F = 1kHz$	55 55	61 63		dB
Crosstalk	Channel Separation, $R_L = 8\Omega$ $F = 1kHz$ $F = 20Hz$ to $20kHz$		-94 -68		dB
T_{WU}	Wake-Up Time ($C_b = 1\mu F$)		110	140	ms
T_{STDB}	Standby Time ($C_b = 1\mu F$)		10		μs
V_{STDBH}	Standby Voltage Level High			1.2	V
V_{STDBL}	Standby Voltage Level Low			0.4	V
Φ_M	Phase Margin at Unity Gain $R_L = 8\Omega$, $C_L = 500pF$		65		Degrees
GM	Gain Margin $R_L = 8\Omega$, $C_L = 500pF$		15		dB
GBP	Gain Bandwidth Product $R_L = 8\Omega$		1.5		MHz

1) Standby mode is activated when V_{stdby} is tied to Gnd

2) All PSRR data limits are guaranteed by production sampling tests
Dynamic measurements - $20 \cdot \log(rms(V_{out})/rms(V_{ripple}))$. V_{ripple} is the sinusoidal signal superimposed upon V_{cc} .

Table 6: Electrical characteristics for $V_{CC} = +2.6V$, $GND = 0V$, $T_{amb} = 25^{\circ}C$ (unless otherwise specified)

Symbol	Parameter	Min.	Typ.	Max.	Unit
I_{CC}	Supply Current No input signal, no load		6.2	12	mA
$I_{STANDBY}$	Standby Current ¹ No input signal, $V_{stdby} = G_{ND}$, $R_L = 8\Omega$		10	1000	nA
V_{OO}	Output Offset Voltage No input signal, $R_L = 8\Omega$		1	10	mV
P_{out}	Output Power THD = 1% Max, $F = 1kHz$, $R_L = 8\Omega$	200	250		mW
THD + N	Total Harmonic Distortion + Noise $P_o = 200mWrms$, $A_v = 2$, $20Hz \leq F \leq 20kHz$, $R_L = 8\Omega$		0.1		%
PSRR	Power Supply Rejection Ratio ² $R_L = 8\Omega$, $A_v = 2$, $V_{ripple} = 200mVpp$, Input Grounded $F = 217Hz$ $F = 1kHz$	55 55	60 62		dB
Crosstalk	Channel Separation, $R_L = 8\Omega$ $F = 1kHz$ $F = 20Hz$ to $20kHz$		-95 -68		dB
T_{WU}	Wake-Up Time ($C_b = 1\mu F$)		125	150	ms
T_{STDB}	Standby Time ($C_b = 1\mu F$)		10		μs
V_{STDBH}	Standby Voltage Level High			1.2	V
V_{STDBL}	Standby Voltage Level Low			0.4	V
Φ_M	Phase Margin at Unity Gain $R_L = 8\Omega$, $C_L = 500pF$		65		Degrees
GM	Gain Margin $R_L = 8\Omega$, $C_L = 500pF$		15		dB
GBP	Gain Bandwidth Product $R_L = 8\Omega$		1.5		MHz

1) Standby mode is activated when V_{stdby} is tied to Gnd

2) All PSRR data limits are guaranteed by production sampling tests
Dynamic measurements - $20 \cdot \log(\text{rms}(V_{out})/\text{rms}(V_{ripple}))$. V_{ripple} is the sinusoidal signal superimposed upon V_{cc} .

Figure 2: Open loop frequency response

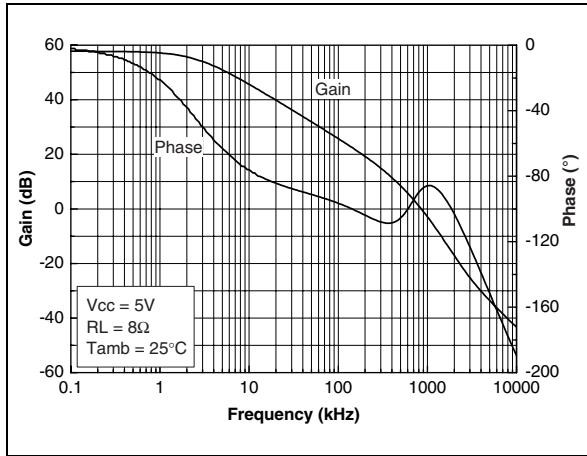

Figure 5: Open loop frequency response

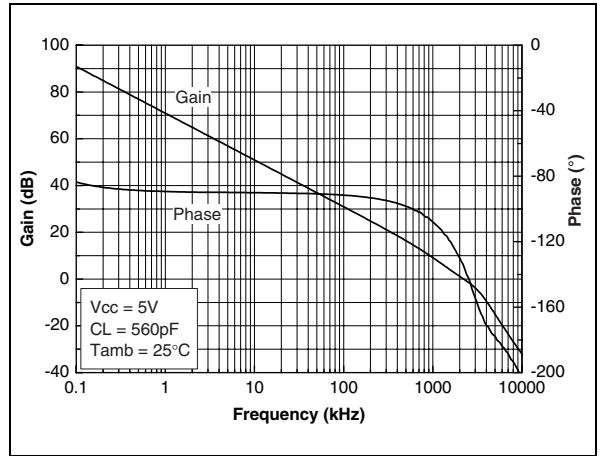

Figure 3: Open loop frequency response

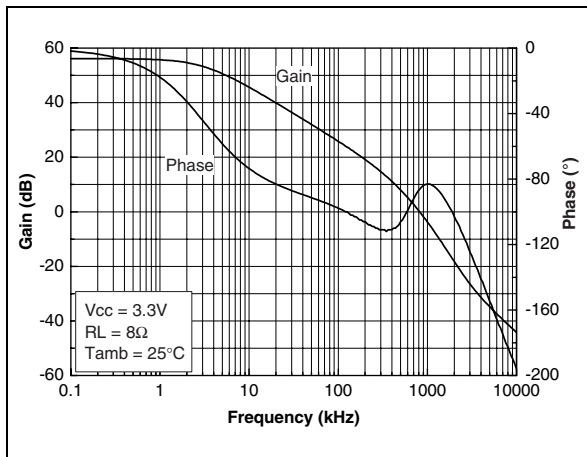

Figure 6: Open loop frequency response

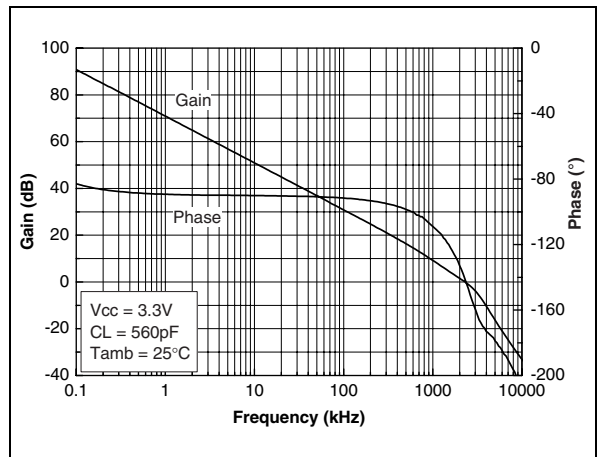

Figure 4: Open loop frequency response

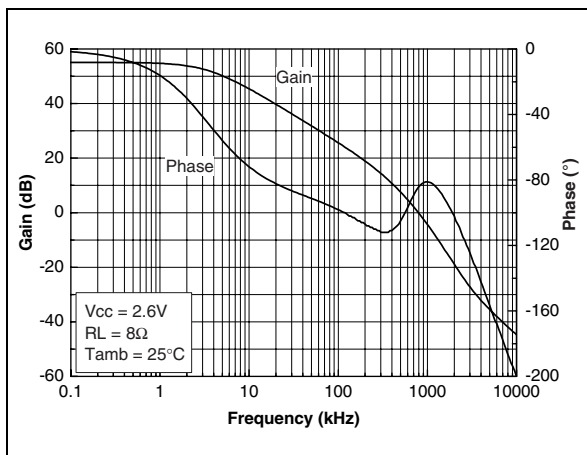

Figure 7: Open loop frequency response

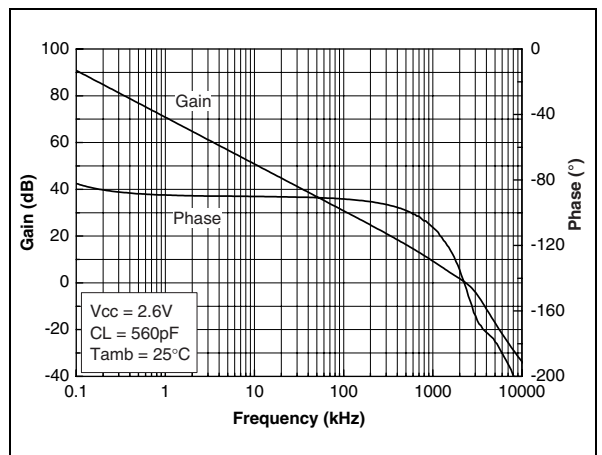

Figure 8: Power supply rejection ratio (PSRR) vs. frequency

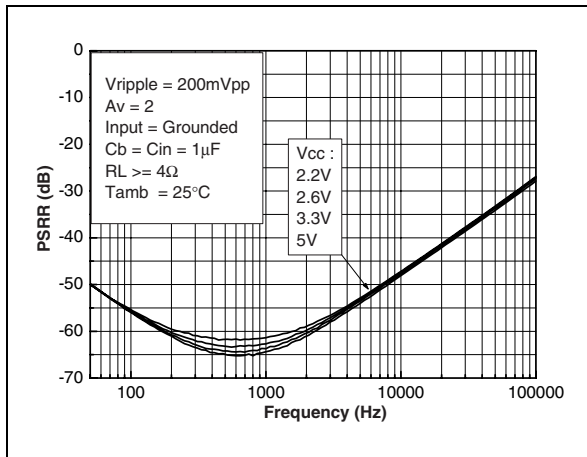

Figure 11: Power supply rejection ratio (PSRR) vs. frequency

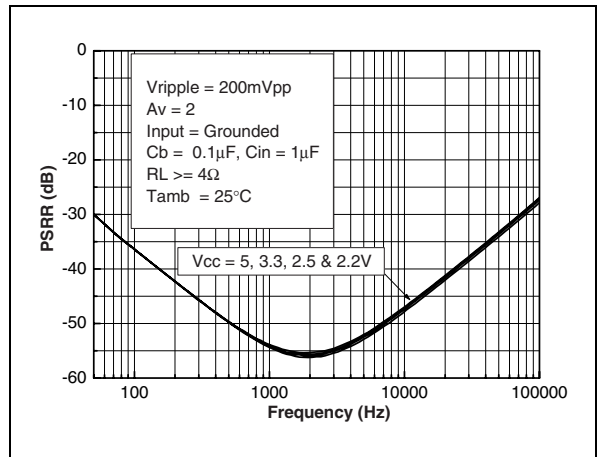

Figure 9: Power supply rejection ratio (PSRR) vs. frequency

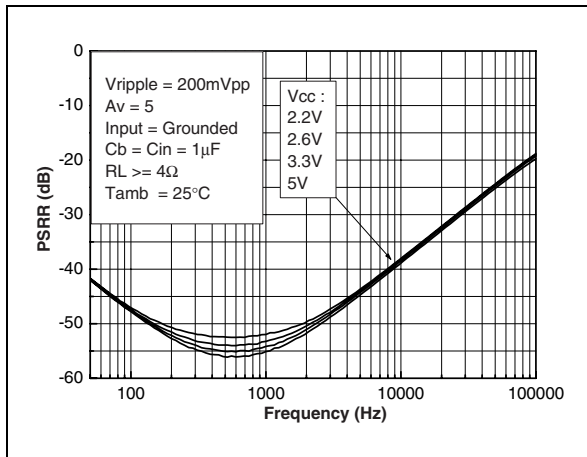

Figure 12: Power supply rejection ratio (PSRR) vs. frequency

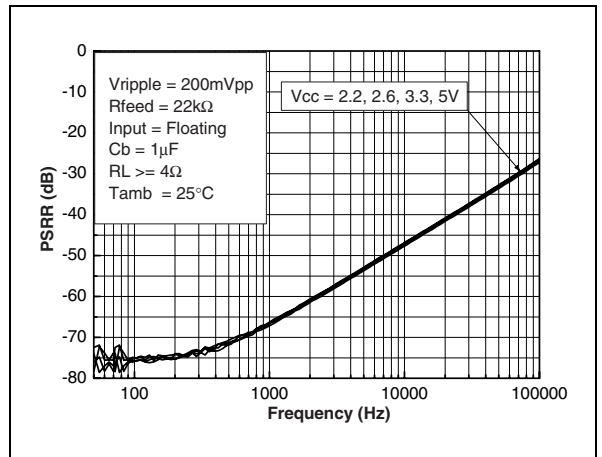

Figure 10: Power supply rejection ratio (PSRR) vs. frequency

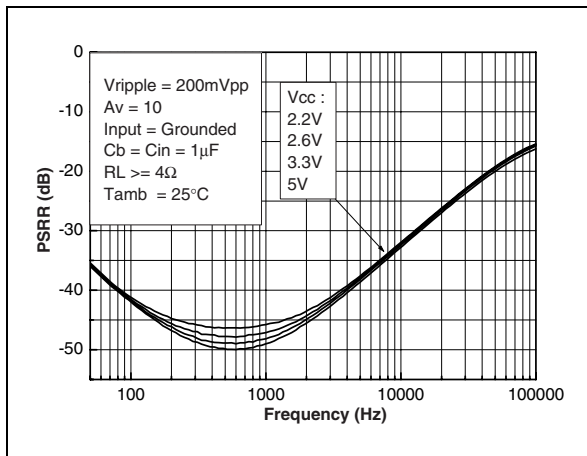

Figure 13: Power supply rejection ratio (PSRR) vs. frequency

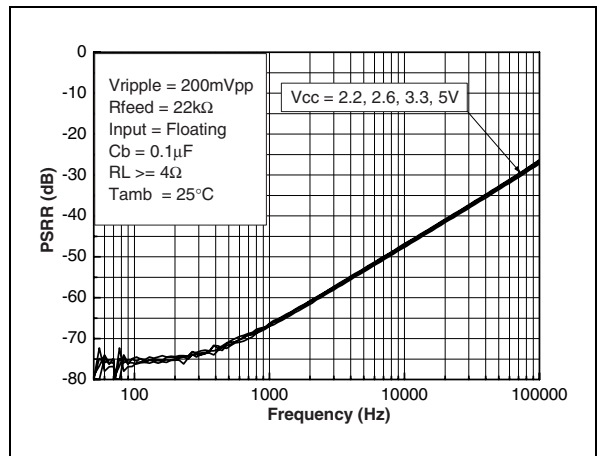

Figure 14: Power supply rejection ratio (PSRR) vs. DC output voltage

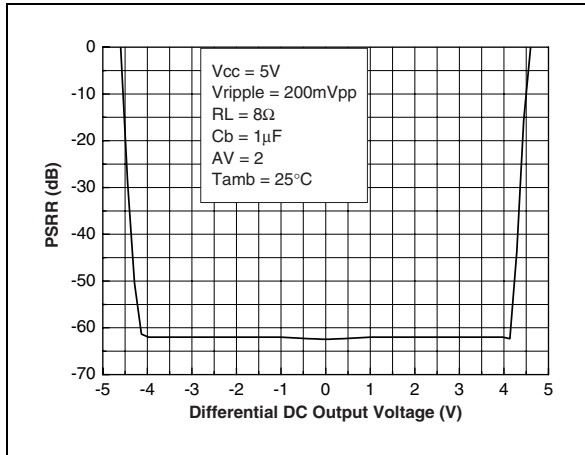

Figure 17: Power supply rejection ratio (PSRR) vs. DC output voltage

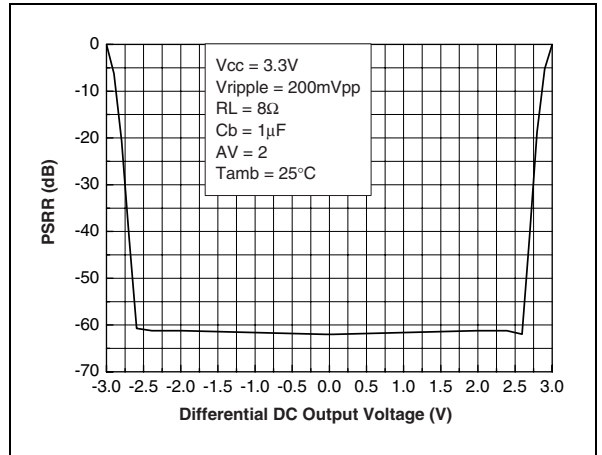

Figure 15: Power supply rejection ratio (PSRR) vs. DC output voltage

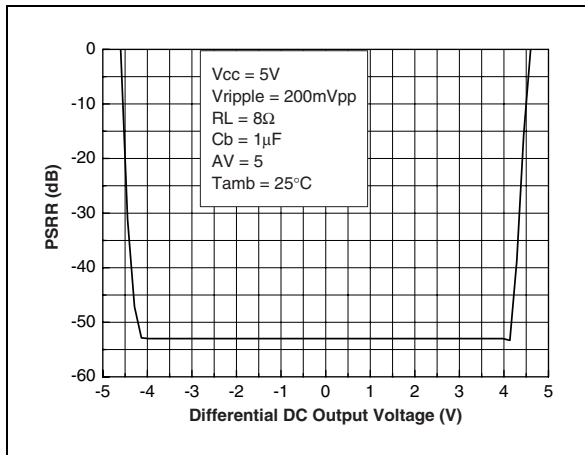

Figure 18: Power supply rejection ratio (PSRR) vs. DC output voltage

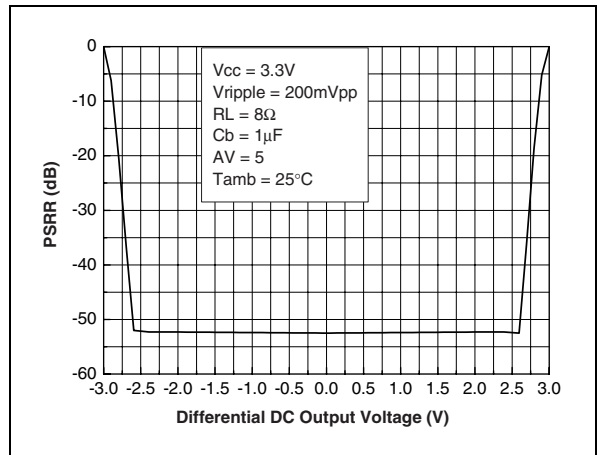

Figure 16: Power supply rejection ratio (PSRR) vs. DC output voltage

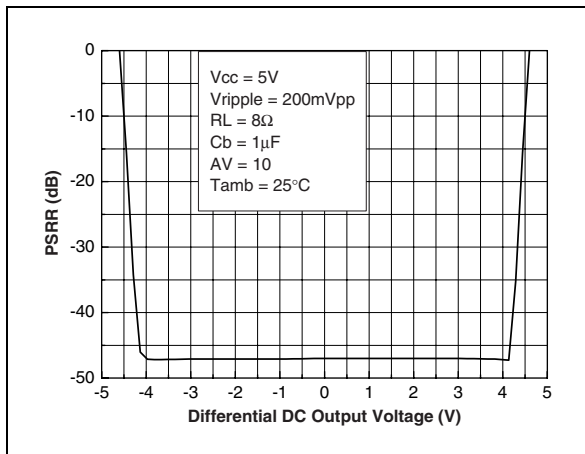

Figure 19: Power supply rejection ratio (PSRR) vs. DC output voltage

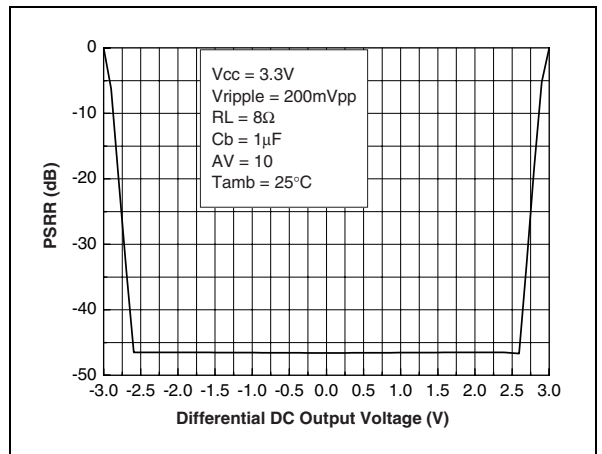

Figure 20: Power supply rejection ratio (PSRR) vs. DC output voltage

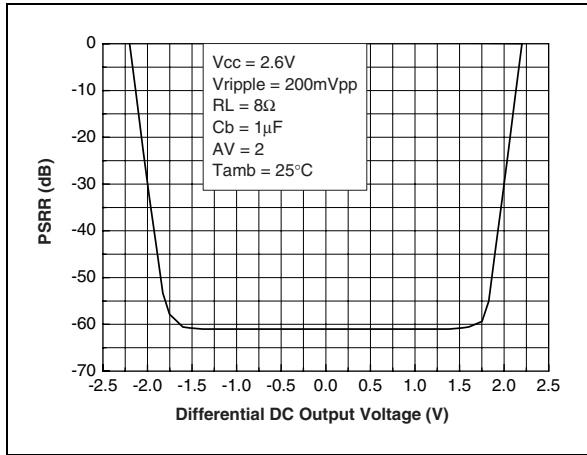

Figure 21: Power supply rejection ratio (PSRR) vs. DC output voltage

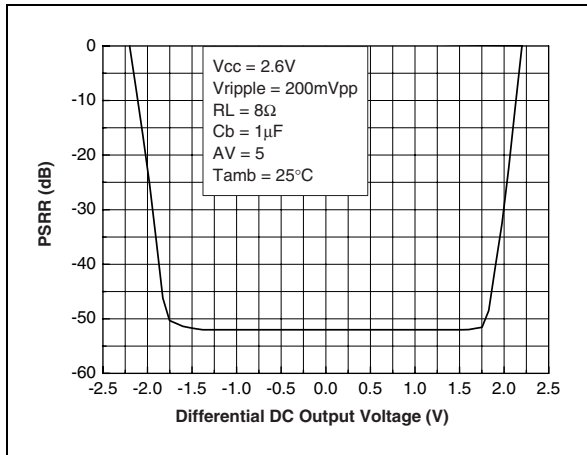

Figure 22: Power supply rejection ratio (PSRR) vs. DC output voltage

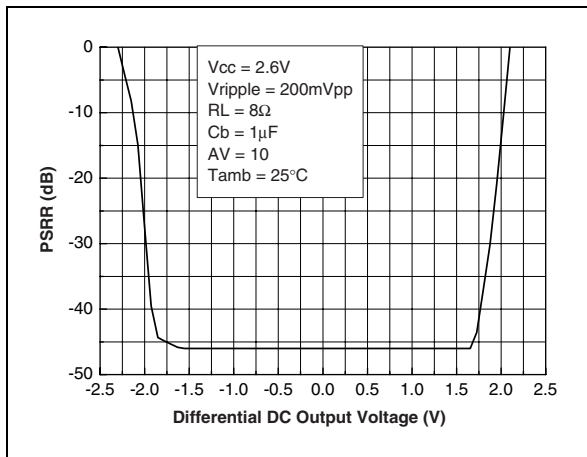

Figure 23: Power supply rejection ratio (PSRR) at f=217Hz vs. bypass capacitor

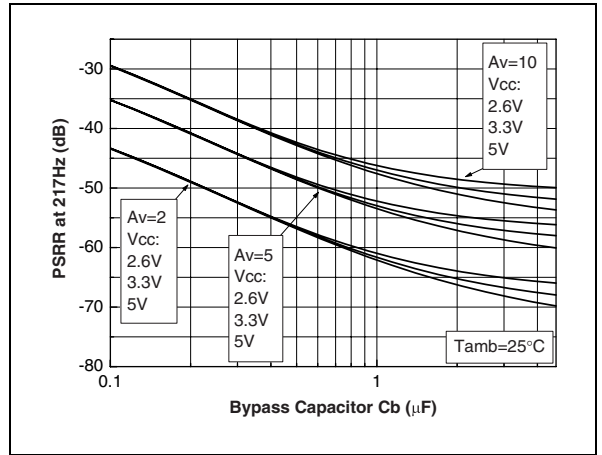

Figure 24: Output power vs. power supply voltage

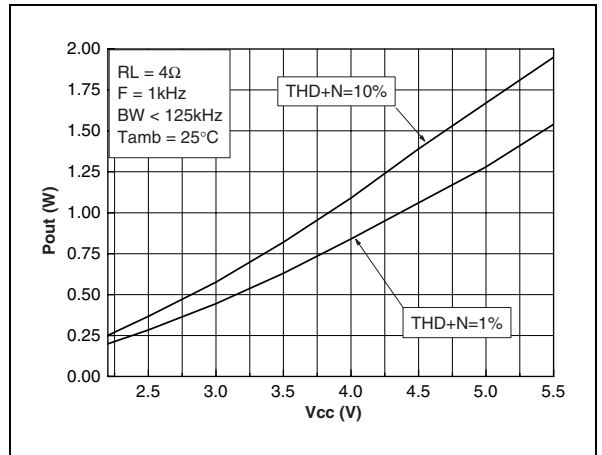

Figure 25: Output power vs. power supply voltage

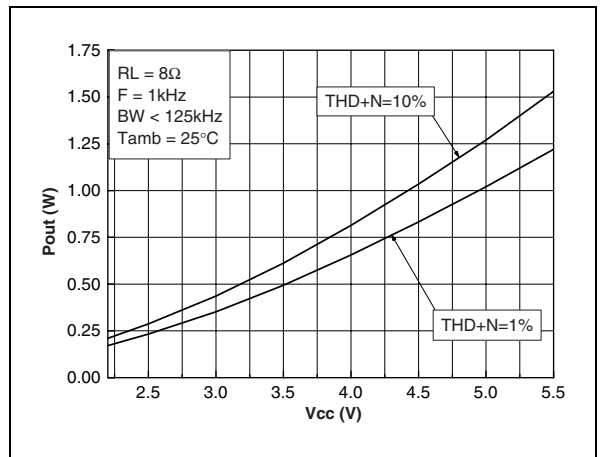

Figure 26: Output power vs. power supply voltage

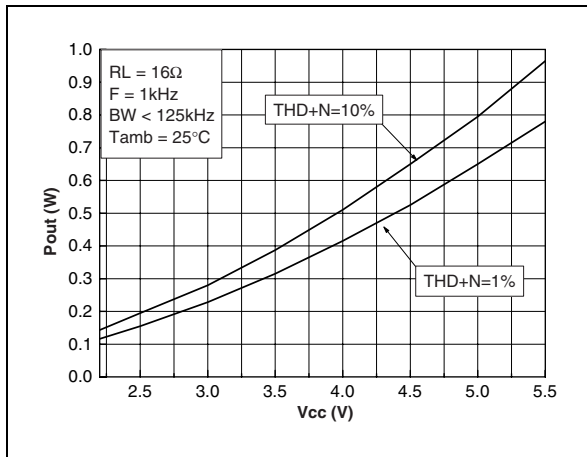

Figure 29: Output power vs. load resistor

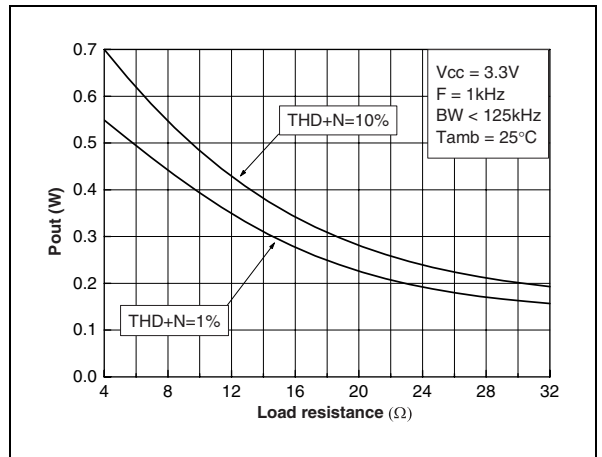

Figure 27: Output power vs. power supply voltage

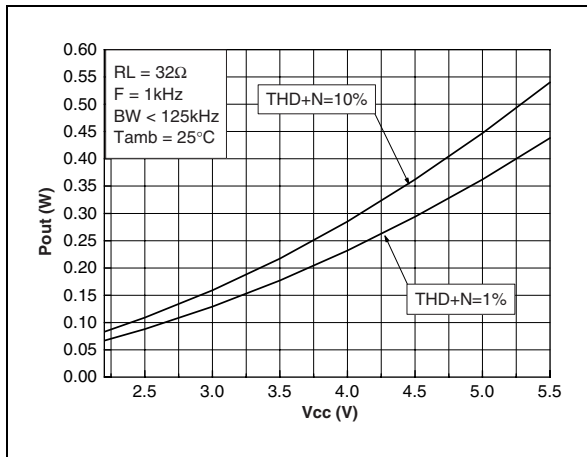

Figure 30: Output power vs. load resistor

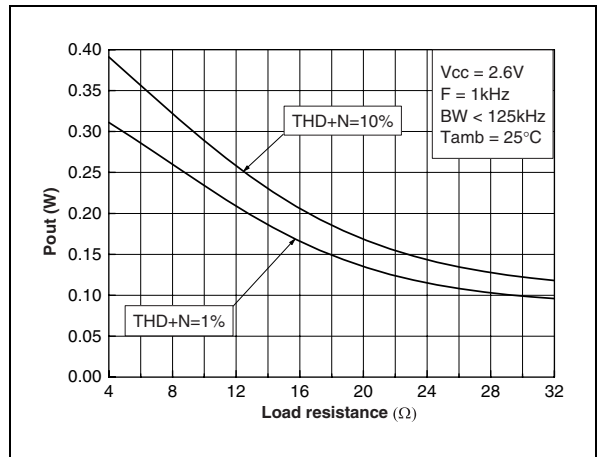

Figure 28: Output power vs. load resistor

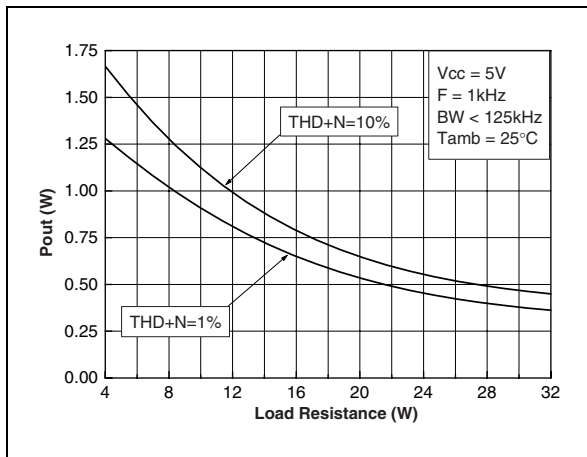

Figure 31: Power dissipation vs. output power

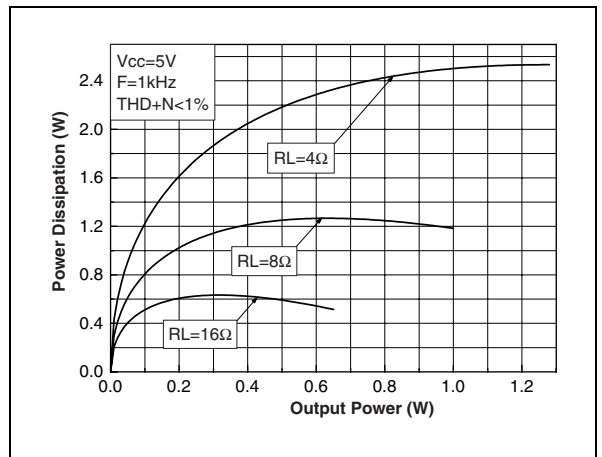

Figure 32: Power dissipation vs. output power

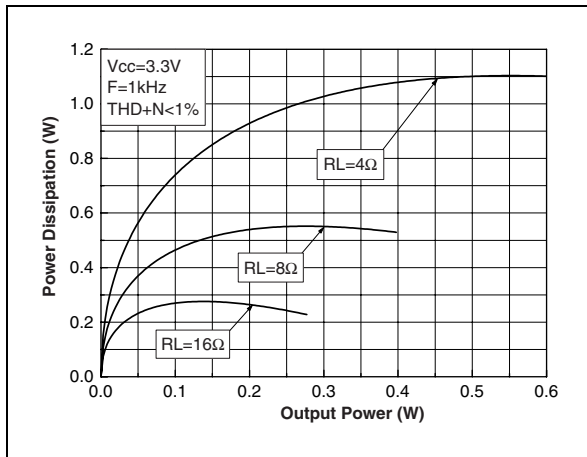

Figure 33: Power dissipation vs. output power

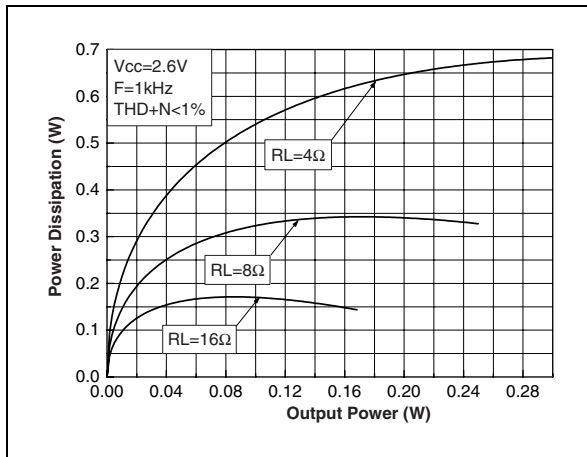

Figure 34: Clipping voltage vs. power supply voltage and load resistor

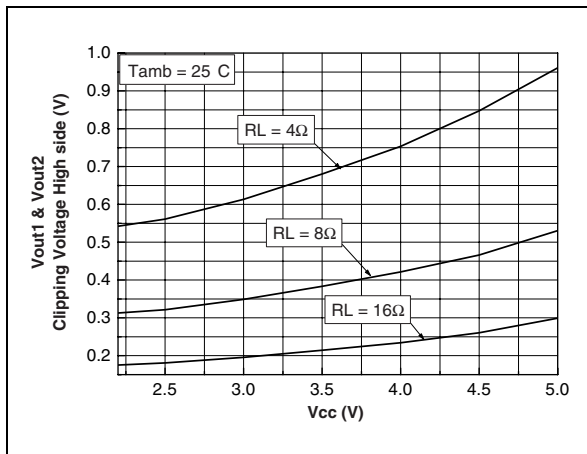

Figure 35: Clipping voltage vs. power supply voltage and load resistor

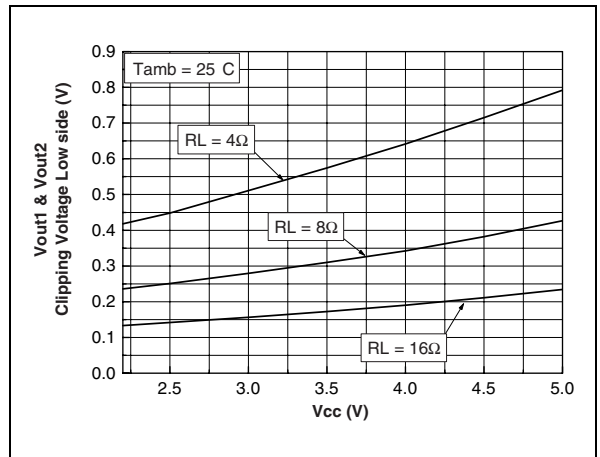

Figure 36: Current consumption vs. power supply voltage

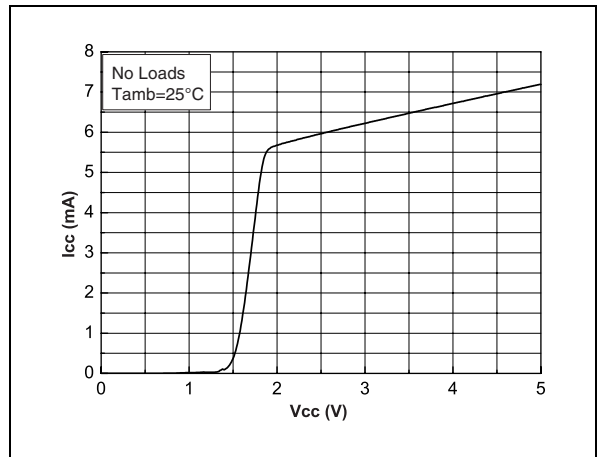

Figure 37: Current consumption vs. standby voltage at Vcc=5V

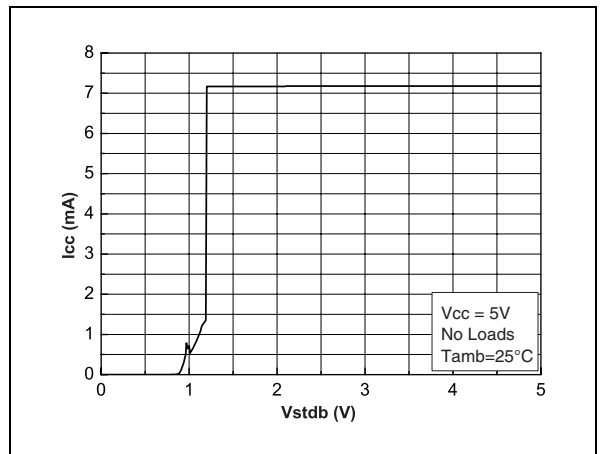

Figure 38: Current consumption vs. standby voltage at $V_{cc}=3.3V$

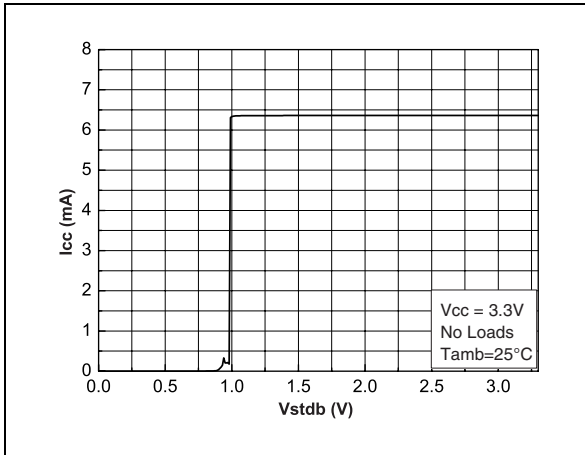

Figure 39: Current consumption vs. standby voltage at $V_{cc}=2.6V$

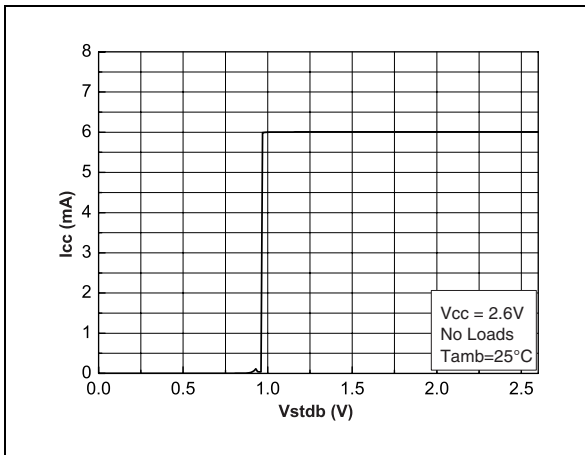

Figure 40: Current consumption vs. standby voltage at $V_{cc}=2.2V$

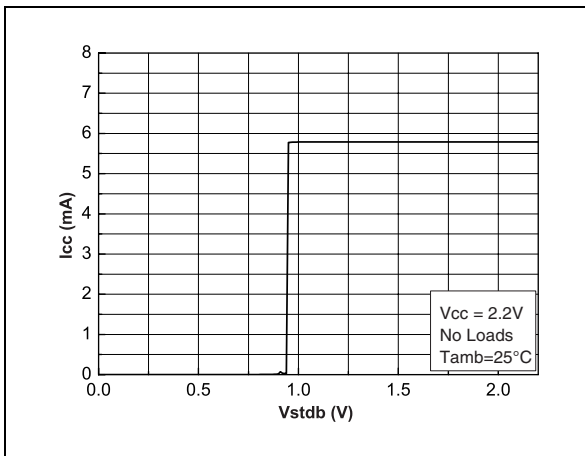

Figure 41: THD+N vs. output power

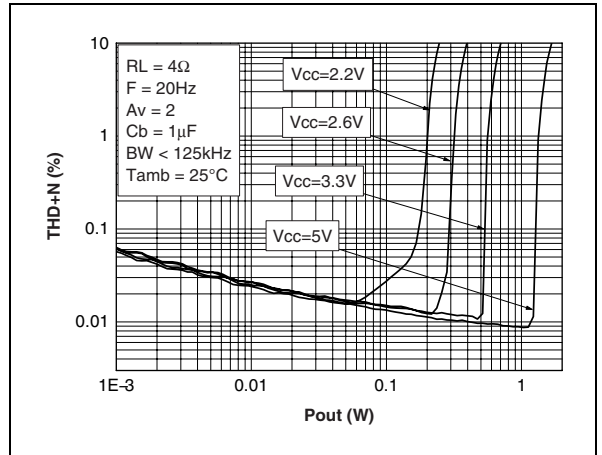

Figure 42: THD+N vs. output power

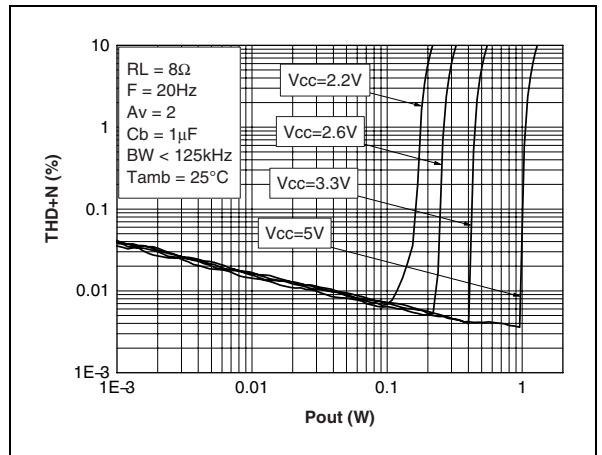

Figure 43: THD+N vs. output power

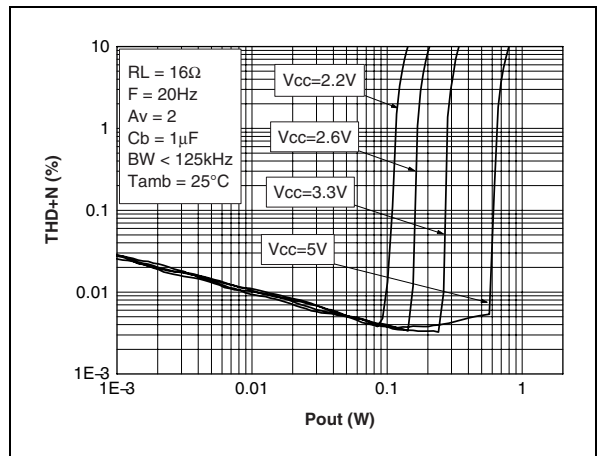

Figure 44: THD+N vs. output power

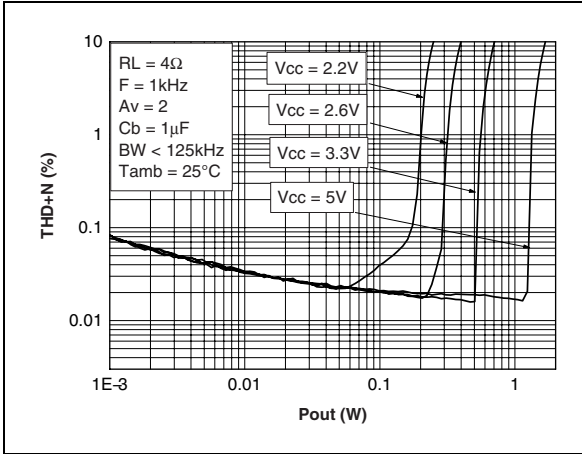

Figure 47: THD+N vs. output power

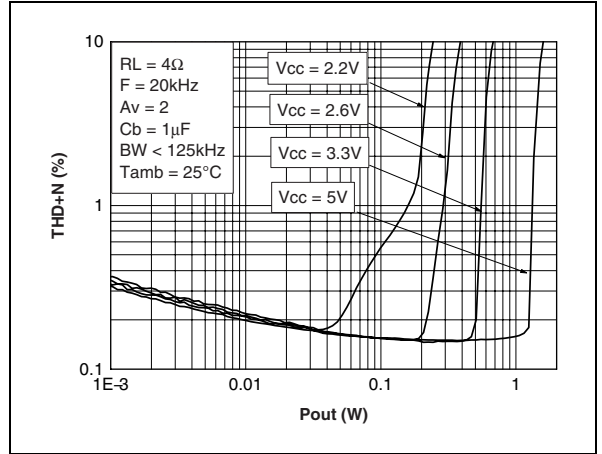

Figure 45: THD+N vs. output power

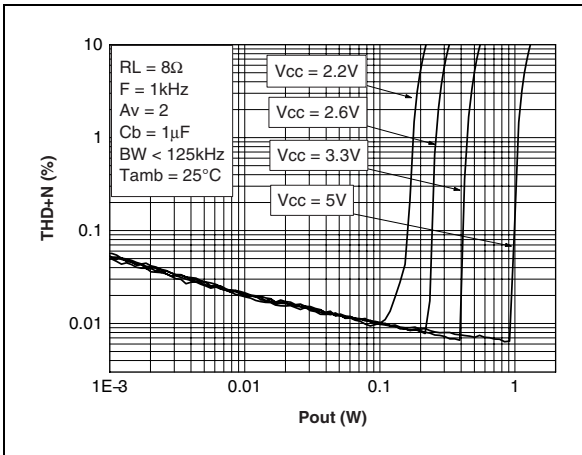

Figure 48: THD+N vs. output power

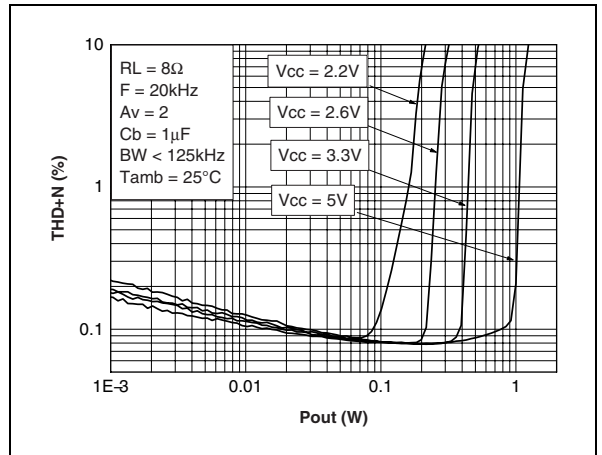

Figure 46: THD+N vs. output power

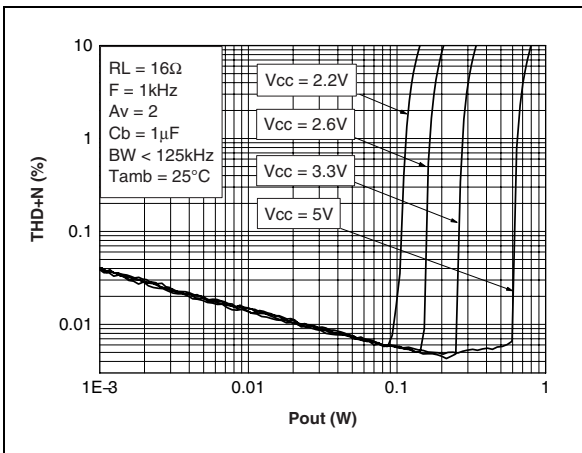

Figure 49: THD+N vs. output power

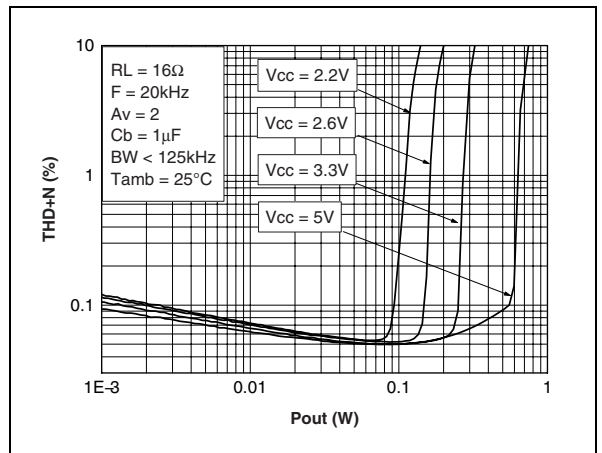

Figure 50: THD+N vs. frequency

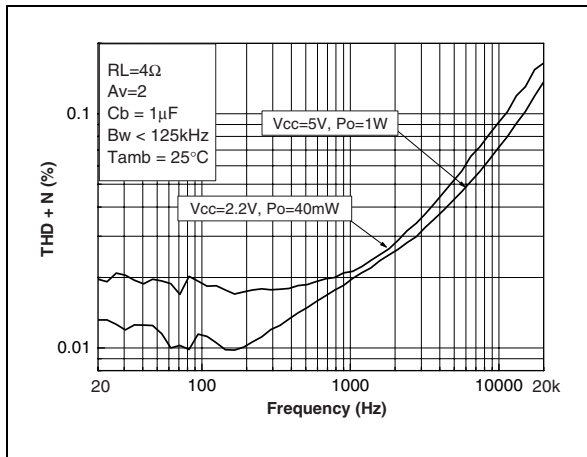

Figure 53: Signal to noise ratio vs. power supply with unweighted filter (20Hz to 20kHz)

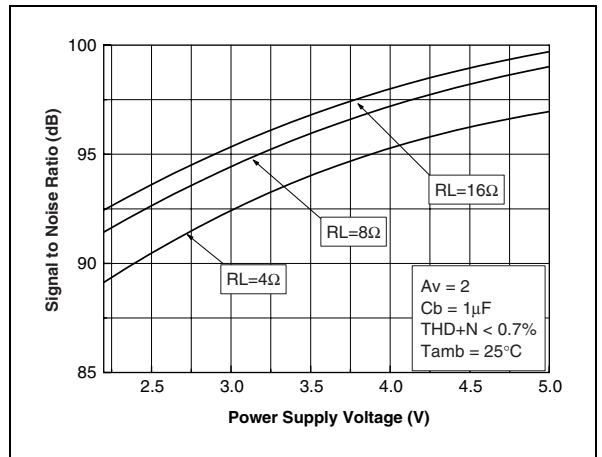

Figure 51: THD+N vs. frequency

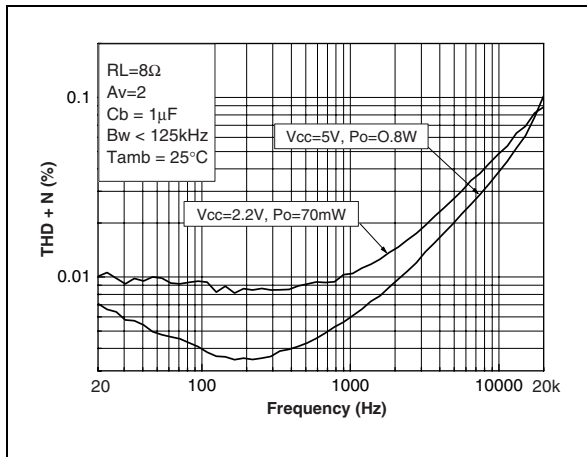

Figure 54: Signal to noise ratio vs. pwr supply with unweighted filter (20Hz to 20kHz)

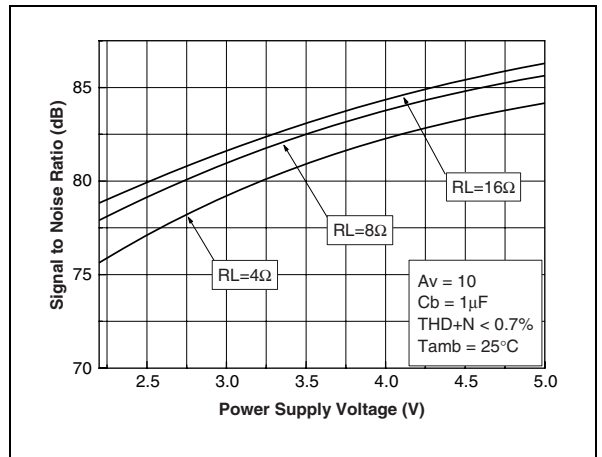

Figure 52: THD+N vs. frequency

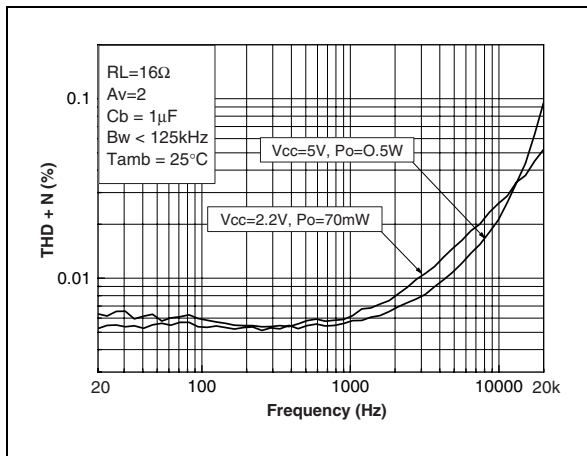

Figure 55: Signal to noise ratio vs. power supply with A weighted filter

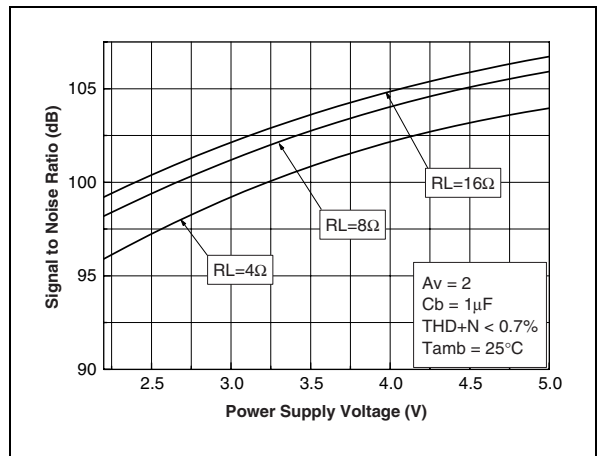

Figure 56: Signal to noise ratio vs. power supply with A weighted filter

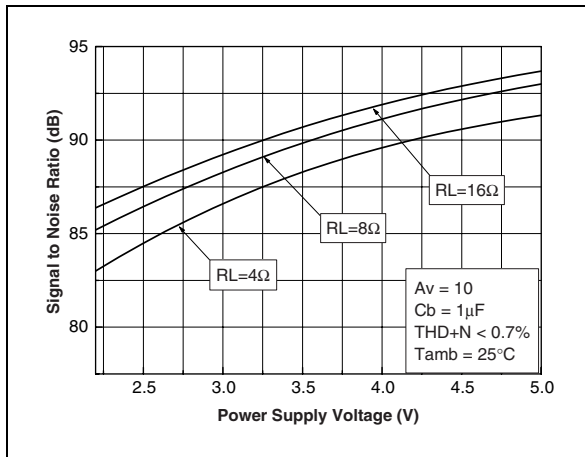

Figure 59: Crosstalk vs. frequency

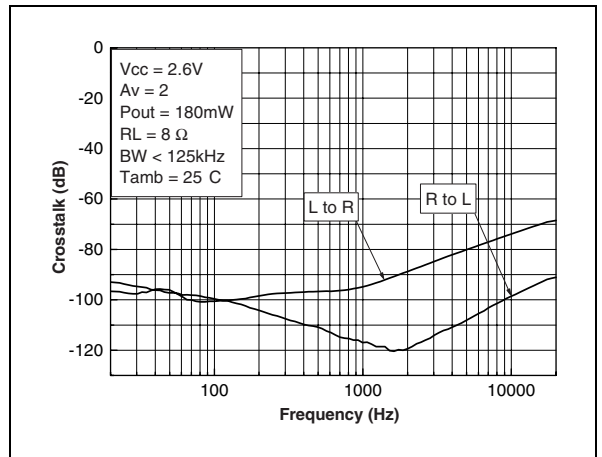

Figure 57: Crosstalk vs. frequency

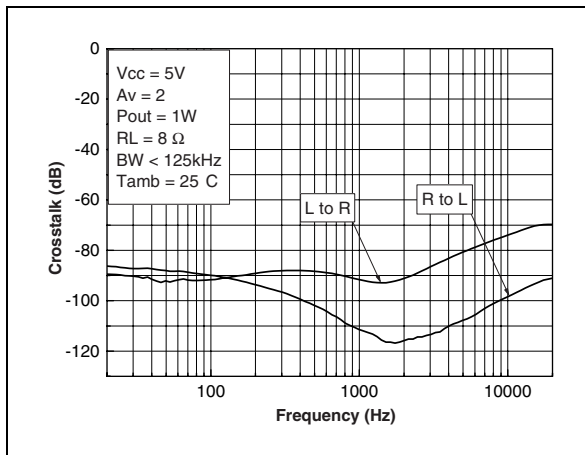

Figure 60: Crosstalk vs. frequency

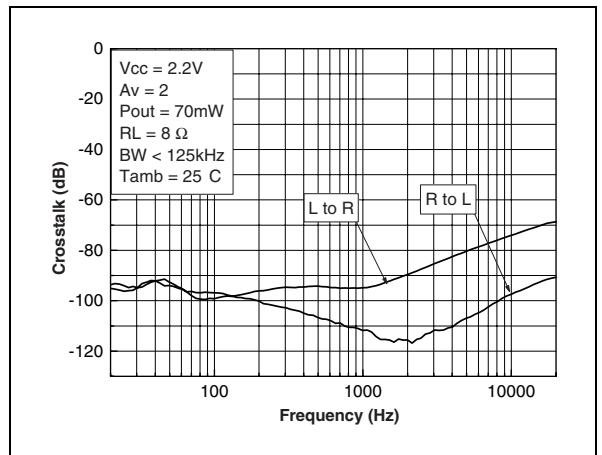

Figure 58: Crosstalk vs. frequency

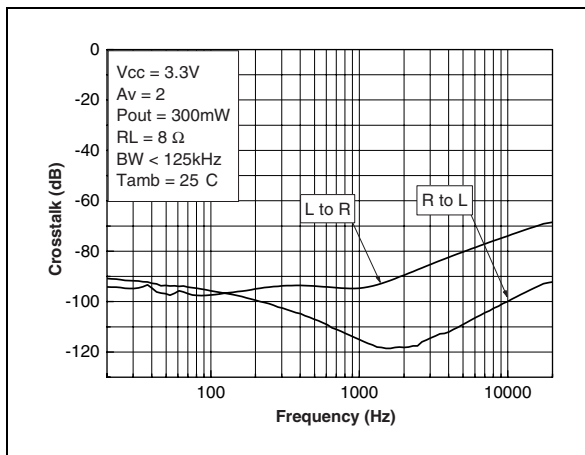

Figure 61: Output noise voltage, device ON

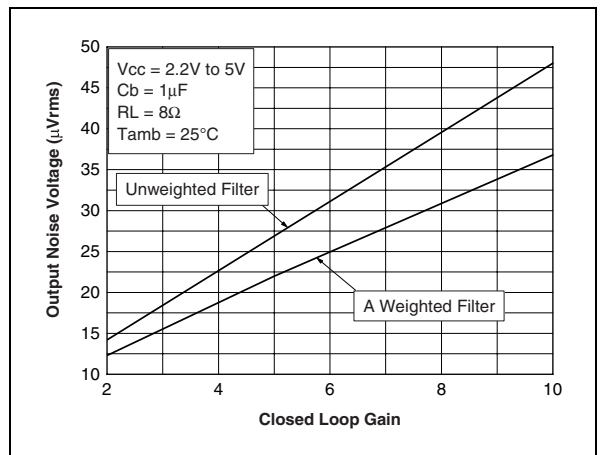

Figure 62: Output noise voltage, device in standby

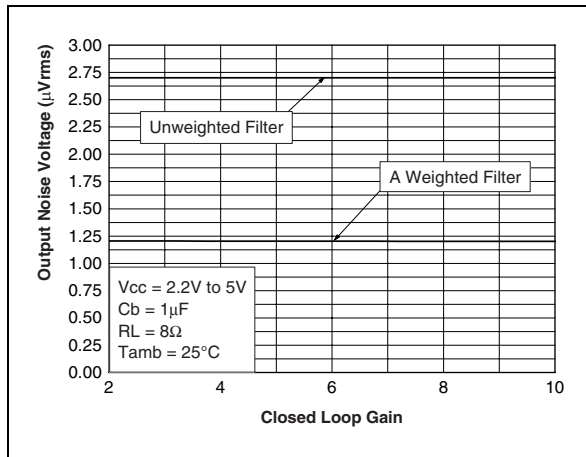
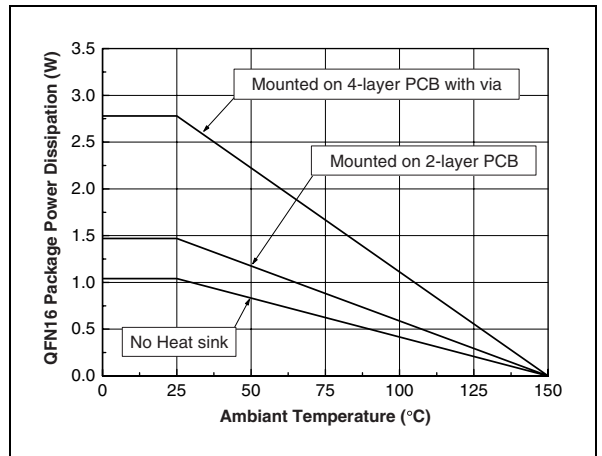

Figure 63: Power derating curves



4 Application Information

The TS4984 integrates two monolithic power amplifiers with a BTL (Bridge Tied Load) output type (explained in more detail in [Section 4.1](#)). For this discussion, only the left-channel amplifier will be referred to.

Referring to the schematic in [Figure 64](#), we assign the following variables and values:

$$V_{in} = IN-L$$

$$V_{out1} = VO-L, V_{out2} = VO+R$$

$$R_{in} = Rin-L, R_{feed} = Rfeed-L$$

$$C_{feed} = Cfeed-L$$

Figure 64: Typical application schematic - left channel

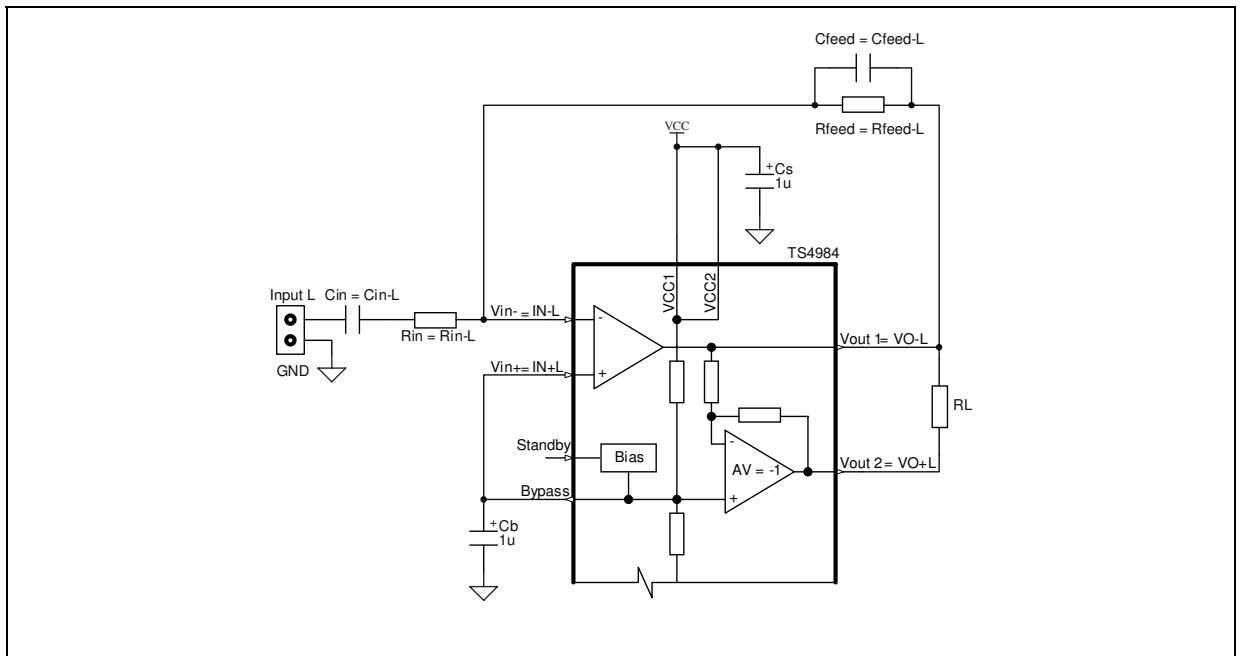

4.1 BTL configuration principle

BTL (Bridge Tied Load) means that each end of the load is connected to two single-ended output amplifiers. Thus, we have:

$$\text{Single-ended output 1} = V_{out1} = V_{out} \text{ (V)},$$

$$\text{Single-ended output 2} = V_{out2} = -V_{out} \text{ (V)}, V_{out1} - V_{out2} = 2V_{out} \text{ (V)}$$

The output power is:

$$P_{out} = \frac{(2V_{outRMS})^2}{R_L}$$

For the same power supply voltage, the output power in a BTL configuration is four times higher than the output power in a single-ended configuration.

4.2 Gain in typical application schematic

The typical application schematic ([Figure 64](#)) is shown on [page 18](#).

In the flat region (no C_{in} effect), the output voltage of the first stage is:

$$V_{out1} = (-V_{in}) \frac{R_{feed}}{R_{in}} \quad (V)$$

For the second stage: $V_{out2} = -V_{out1}$ (V)

The differential output voltage is:

$$V_{out2} - V_{out1} = 2V_{in} \frac{R_{feed}}{R_{in}} \quad (V)$$

The differential gain, referred to as G_v , for greater convenience, is:

$$G_v = \frac{V_{out2} - V_{out1}}{V_{in}} = 2 \frac{R_{feed}}{R_{in}}$$

V_{out2} is in phase with V_{in} and V_{out1} is phased 180° with V_{in} . This means that the positive terminal of the loudspeaker should be connected to V_{out2} and the negative to V_{out1} .

4.3 Low and high frequency response

In the low frequency region, C_{in} starts to have an effect. C_{in} forms with R_{in} a high-pass filter with a -3dB cut-off frequency:

$$F_{CL} = \frac{1}{2\pi R_{in} C_{in}} \quad (Hz)$$

In the high frequency region, you can limit the bandwidth by adding a capacitor (C_{feed}) in parallel with R_{feed} . It forms a low-pass filter with a -3dB cut-off frequency. F_{CH} is in Hz.

$$F_{CH} = \frac{1}{2\pi R_{feed} C_{feed}} \quad (Hz)$$

The following graph ([Figure 65](#)) shows an example of C_{in} and C_{feed} influence.

Figure 65: Frequency response gain versus C_{in} & C_{feed}

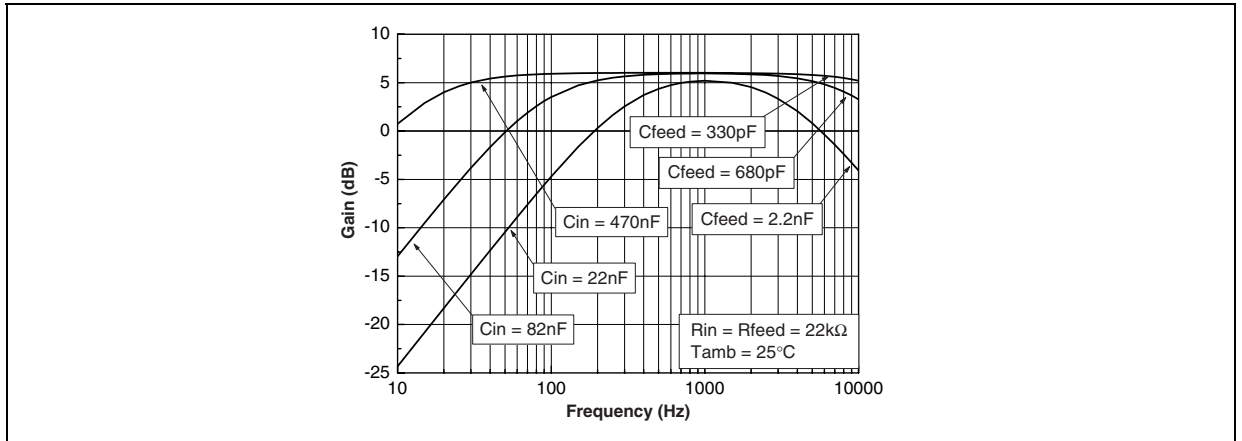

4.4 Power dissipation and efficiency

Hypotheses:

- Voltage and current in the load are sinusoidal (V_{out} and I_{out}).
- Supply voltage is a pure DC source (V_{CC}).

Regarding the load we have:

$$V_{out} = V_{PEAK} \sin \omega t \quad (V)$$

and

$$I_{out} = \frac{V_{out}}{R_L} \quad (A)$$

and

$$P_{out} = \frac{V_{PEAK}^2}{2R_L} \quad (W)$$

Therefore, the average current delivered by the supply voltage is:

$$I_{CC_{AVG}} = 2 \frac{V_{PEAK}}{\pi R_L} \quad (A)$$

The power delivered by the supply voltage is:

$$P_{supply} = V_{CC} \cdot I_{CC_{AVG}} \quad (W)$$

Then, the **power dissipated by each amplifier** is:

$$P_{diss} = P_{supply} - P_{out} \quad (W)$$

$$P_{diss} = \frac{2\sqrt{2}V_{CC}}{\pi\sqrt{R_L}} \cdot \sqrt{P_{out}} - P_{out} \quad (W)$$

and the maximum value is obtained when:

$$\frac{\partial P_{diss}}{\partial P_{out}} = 0$$

and its value is:

$$P_{dissmax} = \frac{2V_{CC}^2}{\pi^2 R_L} \quad (W)$$

Note: This maximum value is only depending on power supply voltage and load values.

The **efficiency**, η , is the ratio between the output power and the power supply:

$$\eta = \frac{P_{out}}{P_{supply}} = \frac{\pi V_{PEAK}}{4V_{CC}}$$

The maximum theoretical value is reached when $V_{PEAK} = V_{CC}$, so that:

$$\frac{\pi}{4} = 78.5\%$$

The TS4984 has two independent power amplifiers, and each amplifier produces heat due to its power dissipation. Therefore, the maximum die temperature is the sum of the each amplifier's maximum power dissipation. It is calculated as follows:

$P_{diss L}$ = Power dissipation due to the left channel power amplifier.

$P_{diss R}$ = Power dissipation due to the right channel power amplifier.

$$Total P_{diss} = P_{diss L} + P_{diss R} \quad (W)$$

In most cases, $P_{diss L} = P_{diss R}$, giving:

$$Total P_{diss} = 2P_{dissL} \quad (W)$$

or, stated differently:

$$Total P_{diss} = \frac{4\sqrt{2}V_{CC}}{\pi\sqrt{R_L}} \sqrt{P_{out}} - 2P_{out} \quad (W)$$

4.5 Decoupling the circuit

Two capacitors are needed to correctly bypass the TS4984. A power supply bypass capacitor C_S and a bias voltage bypass capacitor C_B .

C_S has particular influence on the THD+N in the high frequency region (above 7 kHz) and an indirect influence on power supply disturbances. With a value for C_S of 1 μF , you can expect similar THD+N performances to those shown in the datasheet. For example:

- In the high frequency region, if C_S is lower than 1 μF , it increases THD+N and disturbances on the power supply rail are less filtered.
- On the other hand, if C_S is higher than 1 μF , those disturbances on the power supply rail are more filtered.

C_B has an influence on THD+N at lower frequencies, but its function is critical to the final result of PSRR (with input grounded and in the lower frequency region), in the following manner:

- If C_B is lower than 1 μF , THD+N increases at lower frequencies and PSRR worsens.
- If C_B is higher than 1 μF , the benefit on THD+N at lower frequencies is small, but the benefit to PSRR is substantial.

Note that C_{in} has a non-negligible effect on PSRR at lower frequencies. The lower the value of C_{in} , the higher the PSRR.

4.6 Wake-up time, T_{WU}

When the standby is released to put the device ON, the bypass capacitor C_B will not be charged immediately. As C_B is directly linked to the bias of the amplifier, the bias will not work properly until the C_B voltage is correct. The time to reach this voltage is called wake-up time or T_{WU} and specified in electrical characteristics table with $C_B = 1 \mu\text{F}$.

If C_B has a value other than 1 μF , please refer to the graph in [Figure 66](#) to establish the wake-up time value.

Due to process tolerances, the maximum value of wake-up time could be established by the graph in [Figure 67](#).

Figure 66: Typical wake-up time vs. C_B

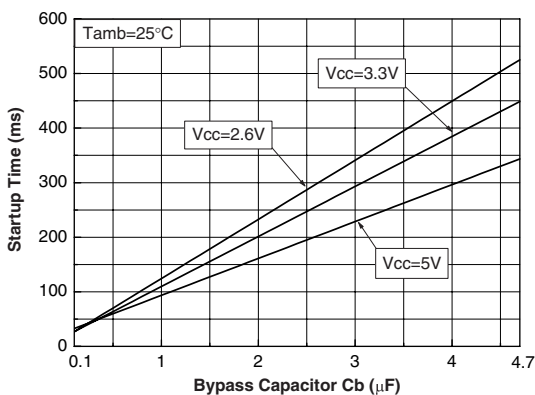
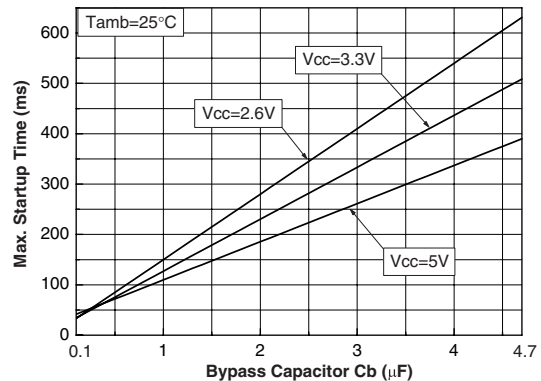

Figure 67: Maximum wake-up time vs. C_B



Note: Bypass capacitor C_B as also a tolerance of typically $\pm 20\%$. To calculate the wake-up time with this tolerance, refer to the previous graph (considering for example for $C_B = 1 \mu\text{F}$ in the range of $0.8 \mu\text{F} \leq 1 \mu\text{F} \leq 1.2 \mu\text{F}$).

4.7 Shutdown time

When the standby command is set, the time required to put the two output stages in high impedance and the internal circuitry in shutdown mode is a few microseconds.

Note: In shutdown mode, Bypass pin and Vin- pin are short-circuited to ground by internal switches. This allows for the quick discharge of the C_b and C_{in} capacitors.

4.8 Pop performance

Pop performance is intimately linked with the size of the input capacitor C_{in} and the bias voltage bypass capacitor C_b .

The size of C_{in} is dependent on the lower cut-off frequency and PSRR values requested. The size of C_b is dependent on THD+N and PSRR values requested at lower frequencies.

Moreover, C_b determines the speed with which the amplifier turns ON. In order to reach near zero pop and click, the equivalent input constant time is:

$$t_{in} = (R_{in} + 2 \text{ k}\Omega) \times C_{in} \text{ (s) with } R_{in} \geq 5 \text{ k}\Omega$$

must not reach the τ_{in} maximum value as indicated in the graph below in [Figure 68](#).

Figure 68: τ_{in} max. versus bypass capacitor

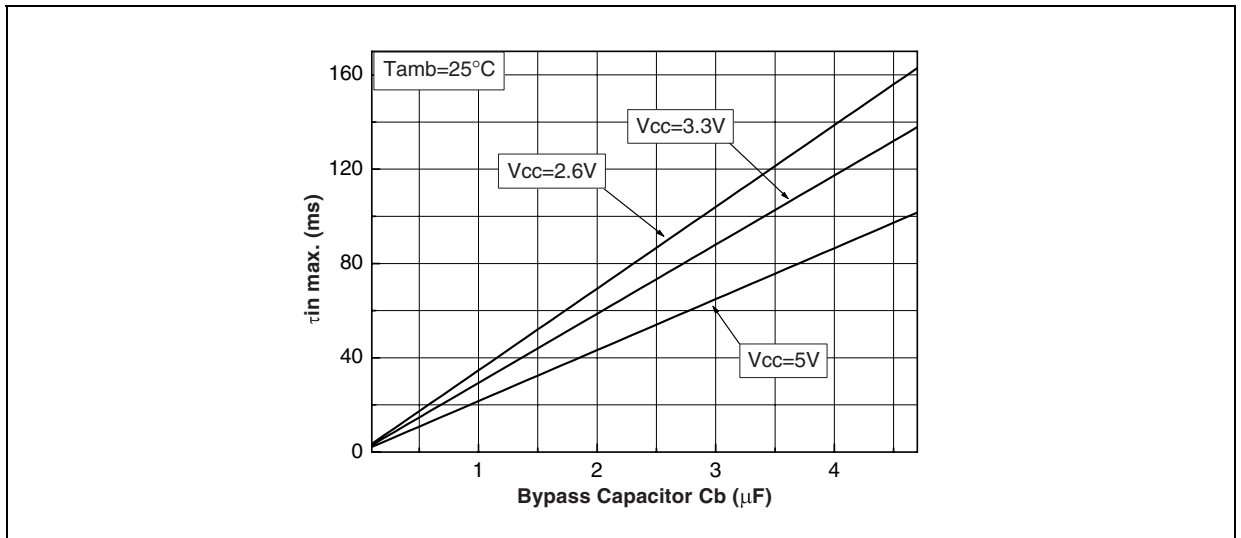

By following previous rules, the TS4984 can reach near zero pop and click even with high gains such as 20 dB.

Example calculation

With $R_{in} = 22 \text{ k}\Omega$ and a 20 Hz, -3 db low cut-off frequency, $C_{in} = 361 \text{ nF}$. So, $C_{in} = 390 \text{ nF}$ with standard value which gives a lower cut-off frequency equal to 18.5 Hz. In this case, $(R_{in} + 2 \text{ k}\Omega) \times C_{in} = 9.36 \text{ ms}$. When referring to the previous graph, if $C_b = 1 \mu\text{F}$ and $V_{cc} = 5 \text{ V}$, we read 20 ms max. This value is twice as high as our current value, thus we can state that pop and click will be reduced to its lowest value. Minimizing both C_{in} and the gain benefits both the pop phenomena, and the cost and size of the application.

4.9 Application example: Differential-input BTL power stereo amplifier

The schematic in [Figure 69](#) shows how to design the TS4984 to work in differential-input mode. For this discussion, only the left-channel amplifier will be referred to.

Let:

$$R_{1R} = R_{2L} = R_1, R_{2R} = R_{2L} = R_2$$

$$C_{inR} = C_{inL} = C_{in}$$

The gain of the amplifier is:

$$G_{dif} = 2 \times \frac{R_2}{R_1}$$

In order to reach the optimal performance of the differential function, R_1 and R_2 should be matched at 1% maximum.

Figure 69: Differential input amplifier configuration

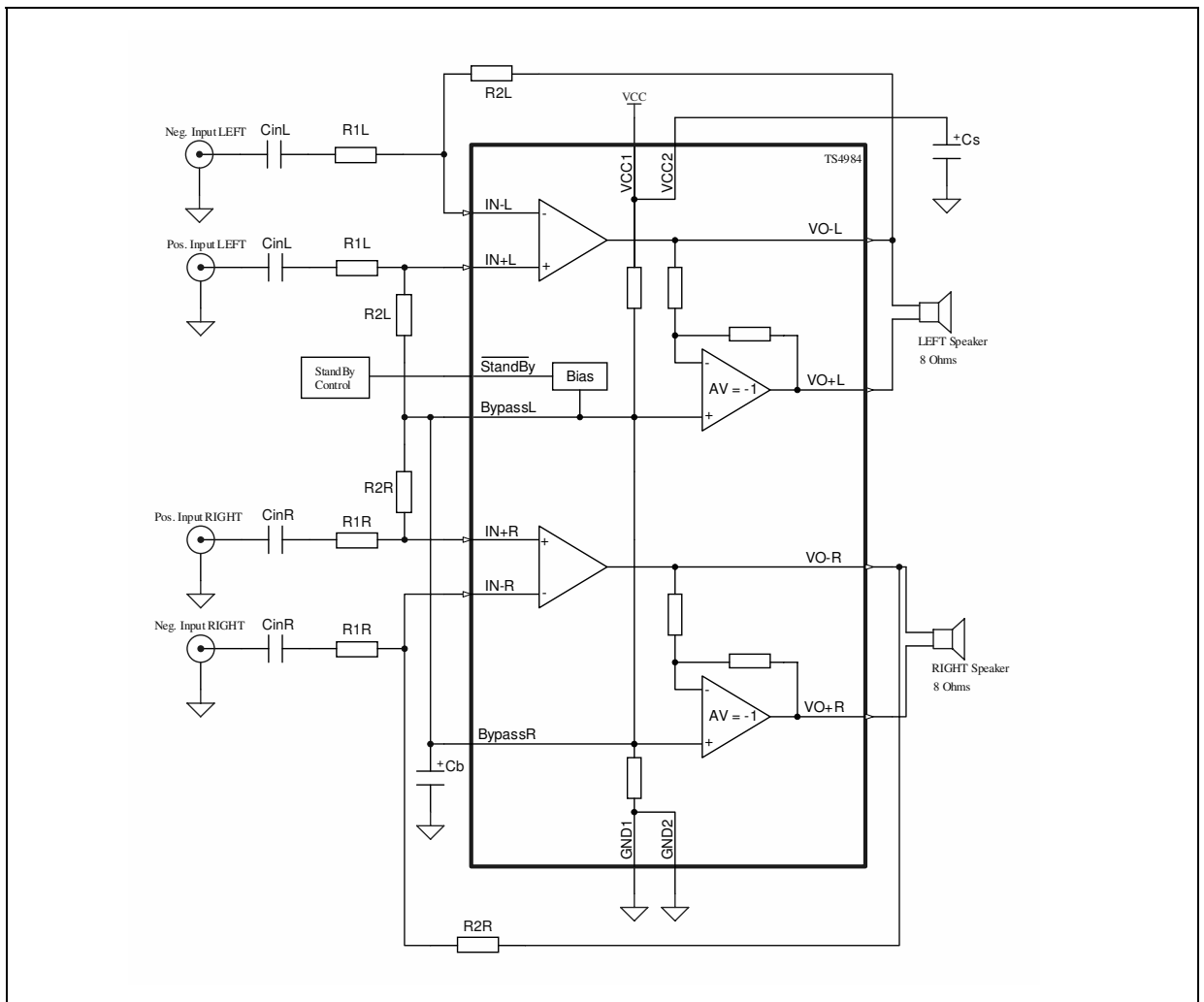

The value of the input capacitor C_{IN} can be calculated with the following formula, using the -3dB lower frequency required (where F_L is the lower frequency required):

$$C_{IN} \approx \frac{1}{2 \pi R_1 F_L} \text{ (F)}$$

Note: This formula is true only if:

$$F_{CB} = \frac{1}{2 \pi (R_1 + R_2) C_B} \text{ (Hz)}$$

is 5 times lower than F_L .

The following bill of materials is provided as an example of a differential amplifier with a gain of 2 and a -3 dB lower cut-off frequency of about 80 Hz.

Table 7: Example of a bill of material

Designator	Part Type
$R_{1L} = R_{1R}$	20kΩ / 1%
$R_{2L} = R_{2R}$	20kΩ / 1%
$C_{inR} = C_{inL}$	100nF
$C_b = C_s$	1μF
U1	TS4984

4.10 Demoboard

A demoboard for the TS4984 is available.

For more information about this demoboard, please refer to **Application Note AN2049**, which can be found on www.st.com.

[Figure 70](#) shows the schematic of the demoboard. [Figure 71](#), [Figure 72](#) and [Figure 73](#) show the component locations, top layer and bottom layer respectively.

Figure 70: Demoboard schematic

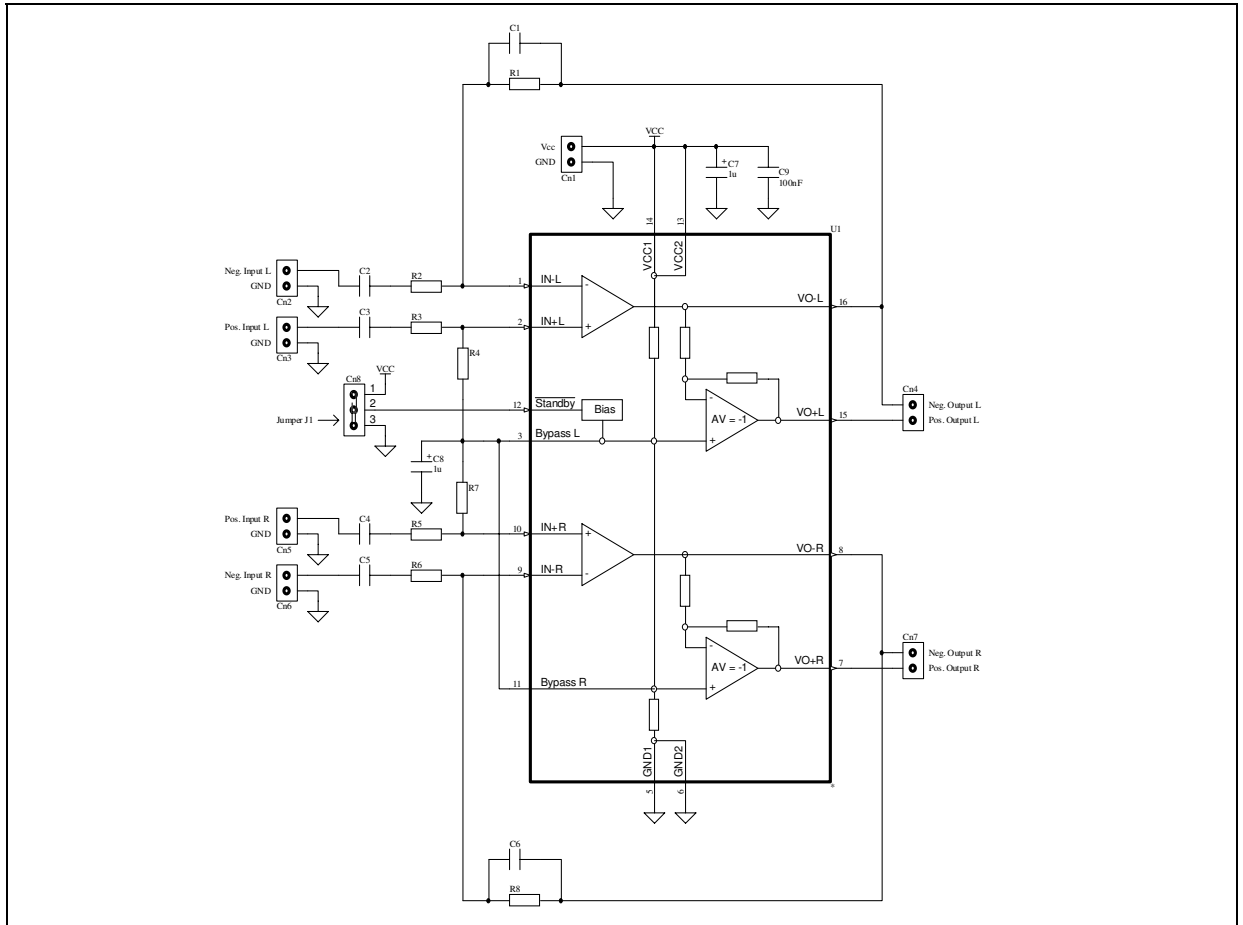

Figure 71: Components location

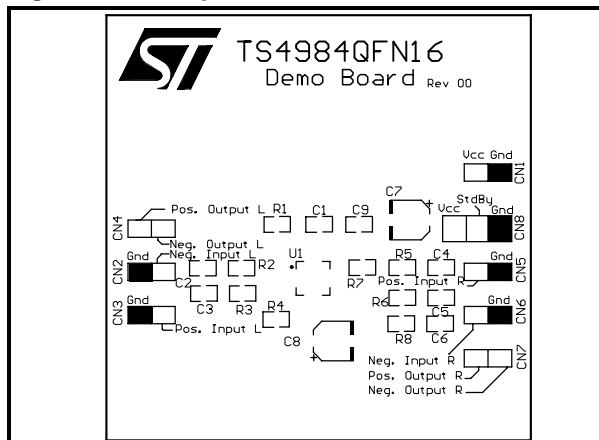

Figure 72: Top layer

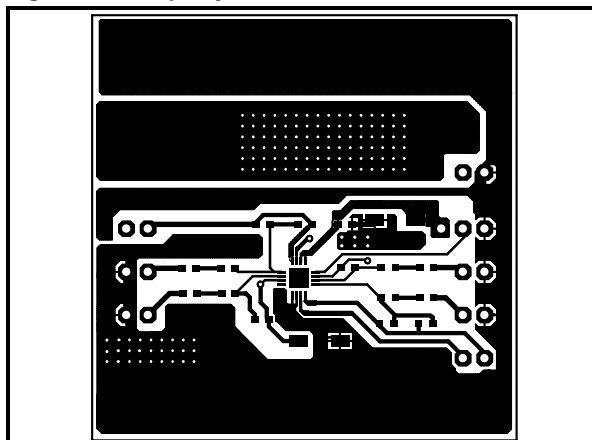
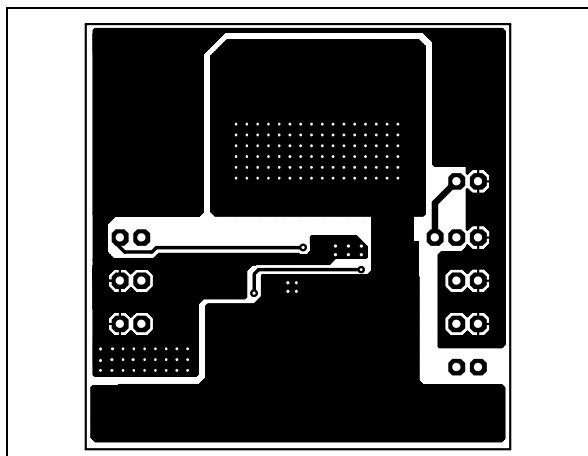
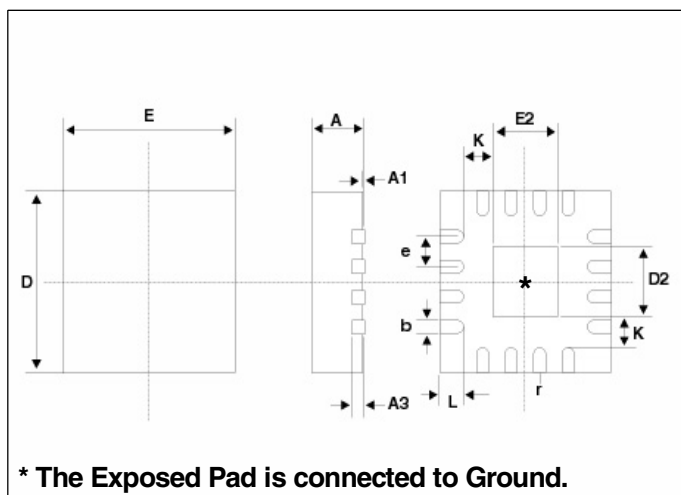

Figure 73: Bottom layer



5 Package Mechanical Data

5.1 Dimensions of QFN16 package



DIMENSIONS			
REF	mm		
	MIN.	TYP.	MAX.
A	0.8	0.9	1.0
A1		0.02	0.05
A3		0.20	
b	0.18	0.25	0.30
D	3.85	4.0	4.15
D2	2.1		2.6
E	3.85	4.0	4.15
E2	2.1		2.6
e		0.50	
K	0.2		
L	0.30	0.40	0.50
r	0.11		

5.2 Footprint recommended data

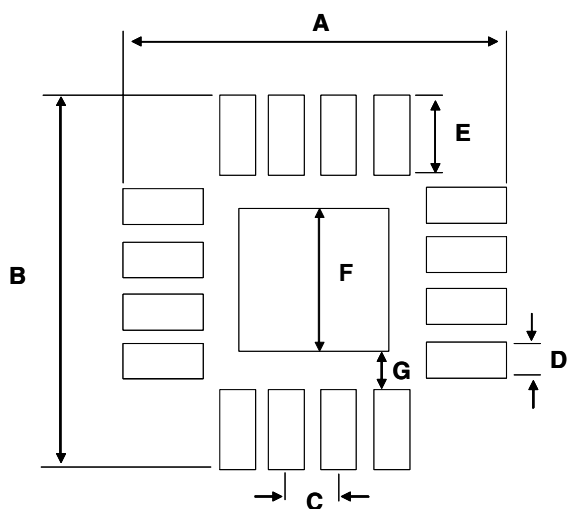

FOOTPRINT DATA	
	mm
A	5.0
B	5.0
C	0.5
D	0.35
E	0.45
F	2.70
G	0.22

6 Revision History

Date	Revision	Description of Changes
01 Jan 2005	1	First Release

Information furnished is believed to be accurate and reliable. However, STMicroelectronics assumes no responsibility for the consequences of use of such information nor for any infringement of patents or other rights of third parties which may result from its use. No license is granted by implication or otherwise under any patent or patent rights of STMicroelectronics. Specifications mentioned in this publication are subject to change without notice. This publication supersedes and replaces all information previously supplied. STMicroelectronics products are not authorized for use as critical components in life support devices or systems without express written approval of STMicroelectronics.

The ST logo is a registered trademark of STMicroelectronics
All other names are the property of their respective owners

© 2005 STMicroelectronics - All rights reserved

STMicroelectronics group of companies

Australia - Belgium - Brazil - Canada - China - Czech Republic - Finland - France - Germany - Hong Kong - India - Israel - Italy - Japan - Malaysia - Malta - Morocco - Singapore - Spain - Sweden - Switzerland - United Kingdom - United States of America

www.st.com