

TOSHIBA PHOTO IC SILICON EPITAXIAL PLANAR

# TPS806

PHOTO IC FOR PHOTO INTERRUPTER

PHOTOELECTRIC COUNTER

POSITION AND ROTATIONAL SPEED SENSOR

- TPS806 is a photo IC integrating photo diode, amplifier circuit and waveform shaping circuit in 1 chip.
- Visible light cut resin is used. :  $\lambda_p=900\text{nm}$  (TYP.)
- The same external shape as the infrared LED TLN107A, and is best suited for combination with TLN107A as a photo interrupter.
- High speed response :  $t_{pLH}=6\mu\text{s}$ ,  $t_{pHL}=2\mu\text{s}$  (TYP.)
- When light is received, output becomes low level.

MAXIMUM RATINGS ( $T_a = 25^\circ\text{C}$ )

CHARACTERISTIC	SYMBOL	RATING	UNIT
Supply Voltage	$V_{CC}$	17	V
High Level Output Voltage	$V_{OH}$	30	V
Low Level Output Voltage	$I_{OL}$	50	mA
Low Level Output Current Derating ( $T_a > 25^\circ\text{C}$ )	$\Delta I_{OL} / ^\circ\text{C}$	-0.67	mA / $^\circ\text{C}$
Power Dissipation	$P_O$	250	mW
Power Dissipation Derating ( $T_a > 25^\circ\text{C}$ )	$\Delta P_O / ^\circ\text{C}$	-3.33	mW / $^\circ\text{C}$
Operating Temperature Range	$T_{opr}$	-25~85	$^\circ\text{C}$
Storage Temperature Range	$T_{stg}$	-40~100	$^\circ\text{C}$
Soldering Temperature (5s)	$T_{sol}$	260	$^\circ\text{C}$

PIN CONNECTION

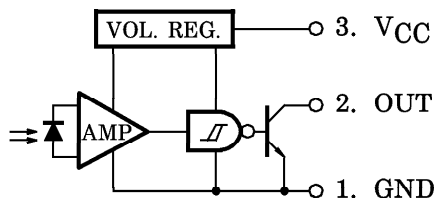

Unit in mm

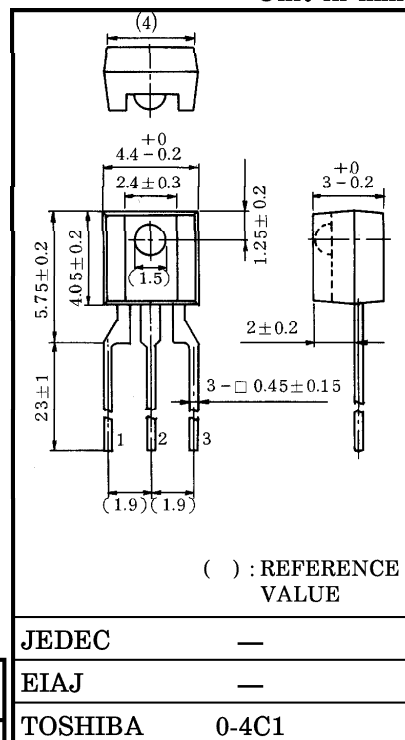

JEDEC	—
EIAJ	—
TOSHIBA	0-4C1

Weight : 0.19g (TYP.)

961001EAA2

- TOSHIBA is continually working to improve the quality and the reliability of its products. Nevertheless, semiconductor devices in general can malfunction or fail due to their inherent electrical sensitivity and vulnerability to physical stress. It is the responsibility of the buyer, when utilizing TOSHIBA products, to observe standards of safety, and to avoid situations in which a malfunction or failure of a TOSHIBA product could cause loss of human life, bodily injury or damage to property. In developing your designs, please ensure that TOSHIBA products are used within specified operating ranges as set forth in the most recent products specifications. Also, please keep in mind the precautions and conditions set forth in the TOSHIBA Semiconductor Reliability Handbook.
- The information contained herein is presented only as a guide for the applications of our products. No responsibility is assumed by TOSHIBA CORPORATION for any infringements of intellectual property or other rights of the third parties which may result from its use. No license is granted by implication or otherwise under any intellectual property or other rights of TOSHIBA CORPORATION or others.
- The information contained herein is subject to change without notice.

OPTO-ELECTRICAL CHARACTERISTICS (Ta = 25°C)

(Ta = 0~70°C, Characteristics with no entry of Ta = 25°C in the test conditions. Typical values are all at 25°C.)

CHARACTERISTIC		SYMBOL	TEST CONDITION	MIN.	TYP.	MAX.	UNIT	
Supply Voltage		V <sub>CC</sub>		4.5	—	17	V	
Low Level Output Voltage		V <sub>OL</sub>	I <sub>OL</sub> = 16mA, V <sub>CC</sub> = 5V E = 2mW/cm <sup>2</sup>	—	0.07	0.4	V	
High Level Output Current		I <sub>OH</sub>	V <sub>CC</sub> = 5V, V <sub>OH</sub> = 30V, E = 0	—	—	100	μA	
Supply Current	Low Level	I <sub>CCL</sub>	V <sub>CC</sub> = 5V, E = 2mW/cm <sup>2</sup>	—	2.5	5	mA	
	High Level	I <sub>CCH</sub>	V <sub>CC</sub> = 5V, E = 0	—	1.2	3		
“H”→“L” Threshold Radiant Incidence (Note 1)		E <sub>HHL</sub>	V <sub>CC</sub> = 5V, Ta = 25°C	—	0.1	0.3	mW/cm <sup>2</sup>	
			V <sub>CC</sub> = 5V	—	—	0.6		
Histerisis Ratio		E <sub>LH</sub> / E <sub>HHL</sub>	Ta = 25°C, V <sub>CC</sub> = 5V	—	0.65	—	—	
Peak Sensitivity Wavelength		λ <sub>P</sub>		—	900	—	nm	
Switching Time	Propagation Delay Time	“L”→“H”	t <sub>pLH</sub>	Ta = 25°C, V <sub>CC</sub> = 5V E = 2mW/cm <sup>2</sup> R <sub>L</sub> = 280Ω (Note 2)	—	6	—	μs
		“H”→“L”	t <sub>pHL</sub>		—	2	—	
	Rise Time		t <sub>r</sub>		—	0.1	—	
	Fall Time		t <sub>f</sub>		—	0.03	—	

Note 1 : Color temperature = 2870°K, Standard Tungsten Lamp.

Note 2 : Switching time test circuit.

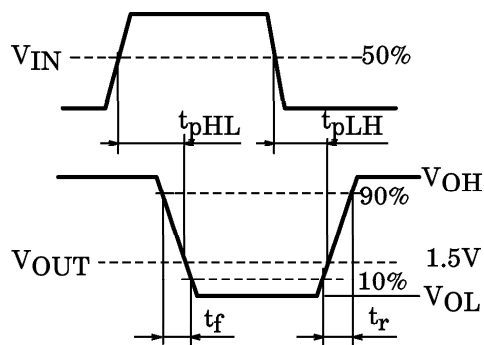
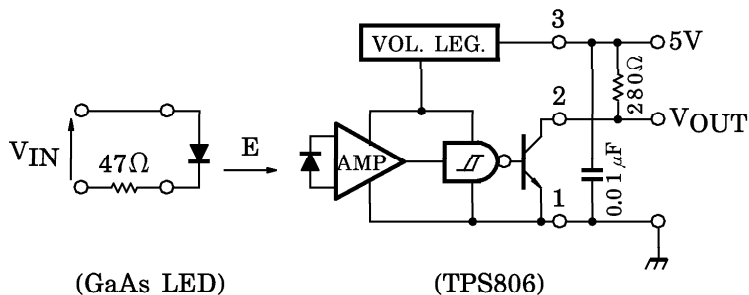

## RECOMMENDED OPERATING CONDITIONS

CHARACTERISTIC	SYMBOL	MIN.	TYP.	MAX.	UNIT
Supply Voltage	V <sub>CC</sub>	4.5	5	16	V
High Level Output Voltage	V <sub>OH</sub>	4.5	—	27	V
Radiant Incidence	E	0.8	—	—	mW/cm <sup>2</sup>
Operating Temperature	T <sub>opr</sub>	0	—	70	°C

## PRECAUTION

Please be careful of the followings.

1. If the lead is formed, the lead should be formed at a distance of 2mm from the body of the device. Soldering shall be performed after lead forming.  
(Soldering portion of lead : above 2mm from the body of the device).
2. Supply the by-pass condenser up to 0.01 $\mu$ F between V<sub>CC</sub> and GND near device to stabilize the power supply line.
3. During 100 $\mu$ s after turning on V<sub>CC</sub>, output voltage changes for stabilizing the inner circuit.

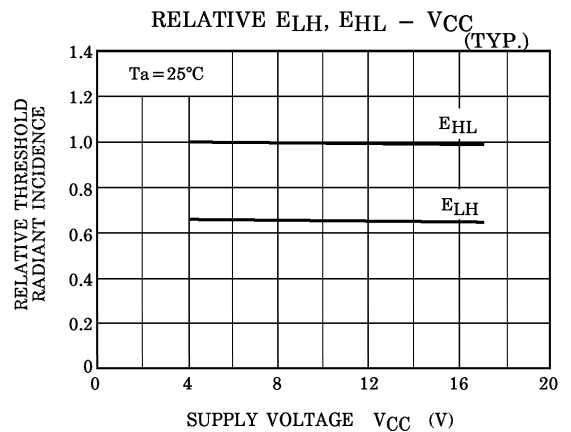
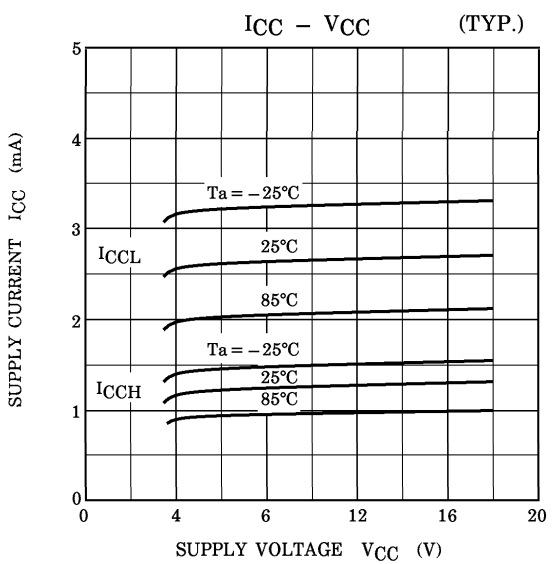
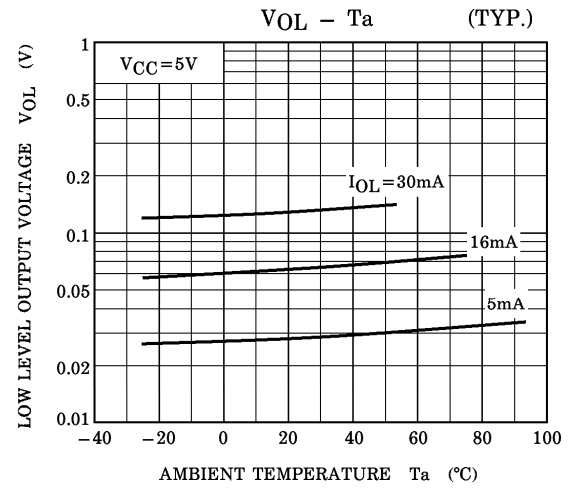
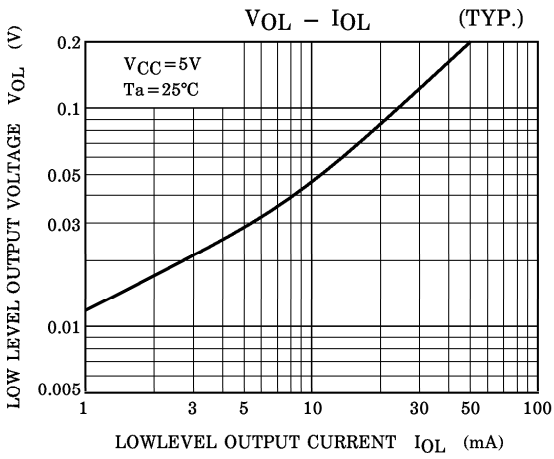
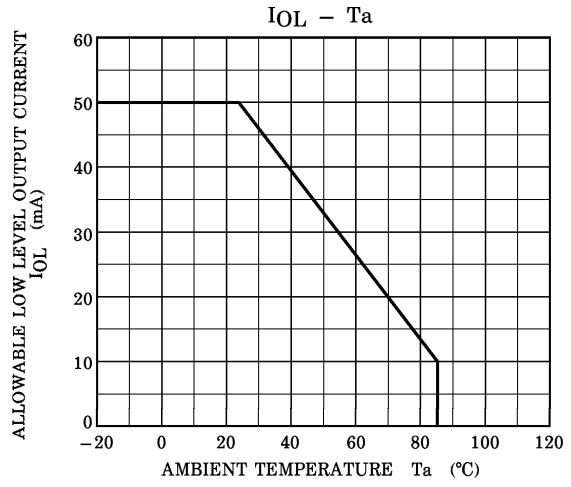
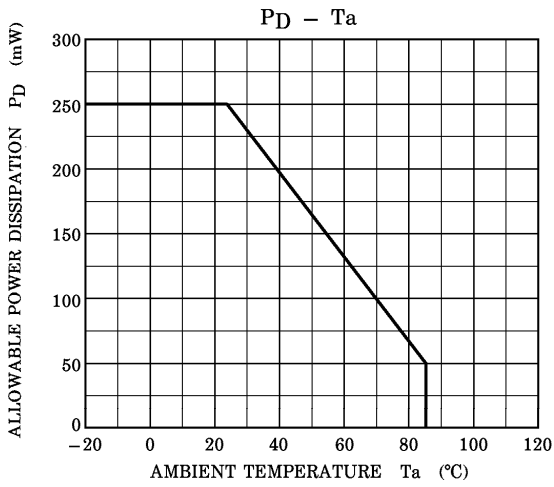

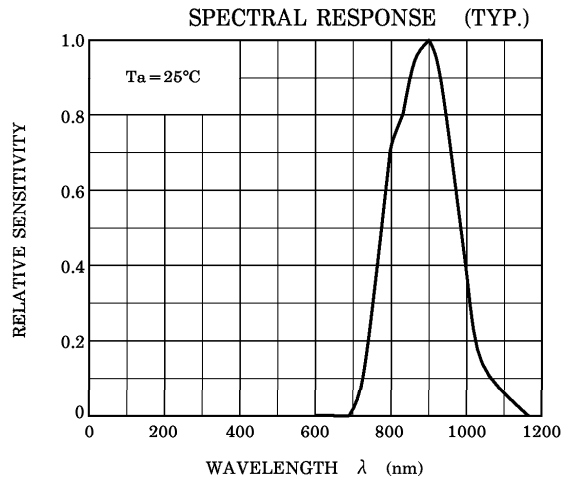
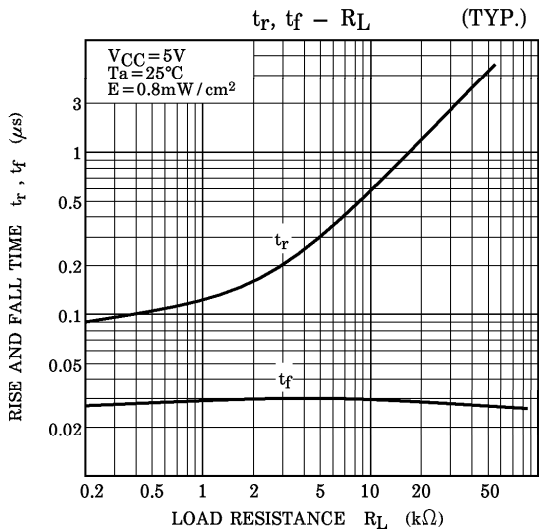
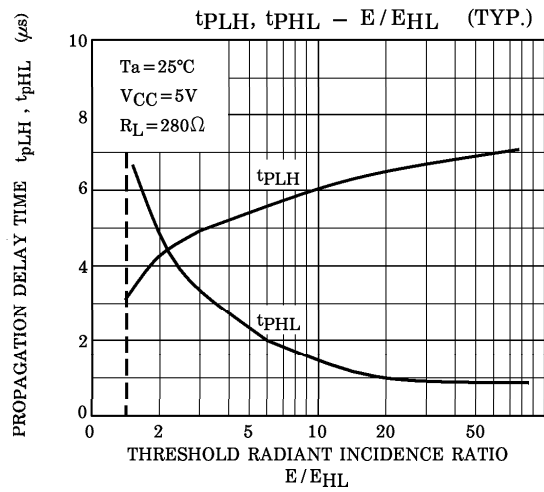
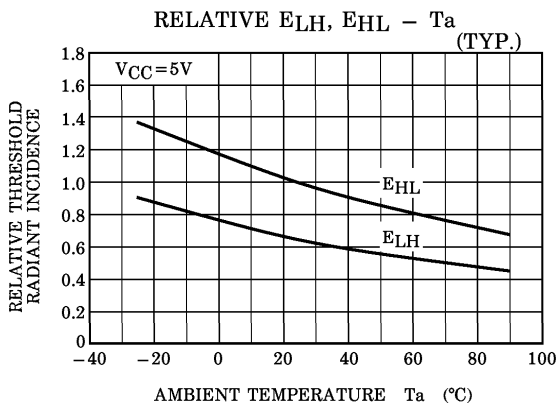

DIRECTIONAL SENSITIVITY CHARACTERISTIC (TYP.)  
( $T_a = 25^{\circ}C$ )

