

FEATURES

- HIGH SURGE CAPABILITY
- HIGH ON-STATE CURRENT
- HIGH STABILITY AND RELIABILITY

DESCRIPTION

The TN1215 series of Silicon Controlled Rectifiers uses a high performance glass passivated technology.

This SCR is designed for power supplies up to 400Hz on resistive or inductive load.

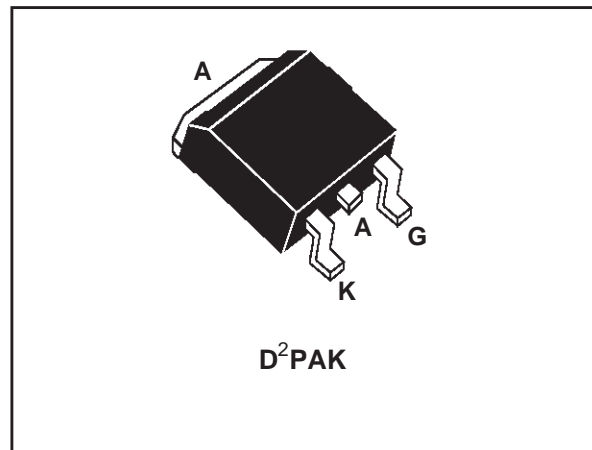
ABSOLUTE MAXIMUM RATINGS

Symbol	Parameter		Value	Unit
$I_{T(RMS)}$	RMS on-state current (180° conduction angle)	$T_c = 110^\circ\text{C}$	12	A
$I_{T(AV)}$	Average on-state current (180° conduction angle)	$T_c = 110^\circ\text{C}$	8	A
I_{TSM}	Non repetitive surge peak on-state current (T_j initial = 25°C)	$t_p = 8.3$ ms	146	A
		$t_p = 10$ ms	140	
I^2t	I^2t Value for fusing	$t_p = 10$ ms	98	A ² s
di/dt	Critical rate of rise of on-state current $I_G = 100$ mA $di_G/dt = 1$ A/ μ s.		100	A/ μ s
T_{stg} T_j	Storage junction temperature range Operating junction temperature range		- 40 to + 150 - 40 to + 125	°C
TI	Maximum temperature for soldering during 10s		260	°C

Symbol	Parameter	TN1215-		Unit
		600G	800G	
V_{DRM} V_{RRM}	Repetitive peak off-state voltage $T_j = 125^\circ\text{C}$	600	800	V

TN1215-G

THERMAL RESISTANCES

Symbol	Parameter	Value	Unit
Rth(j-a)	Junction to ambient (S=1cm ²)	45	°C/W
Rth(j-c)	Junction to case for D.C	1.3	°C/W

GATE CHARACTERISTICS

$P_G (AV) = 1W$ $P_{GM} = 10W$ ($t_p = 20 \mu s$) $I_{GM} = 4A$ ($t_p = 20 \mu s$) $V_{RGM} = 5V$

ELECTRICAL CHARACTERISTICS

Symbol	Test Conditions		Type	Value	Unit
I _{GT}	V _D = 12V (DC) R _L = 33Ω	T _j = 25°C	MIN	2	mA
			MAX	15	
V _{GT}	V _D = 12V (DC) R _L = 33Ω	T _j = 25°C	MAX	1.3	V
V _{GD}	V _D = V _{DRM} R _L = 3.3kΩ	T _j = 125°C	MIN	0.2	V
I _H	I _T = 100mA Gate open	T _j = 25°C	MAX	30	mA
I _L	I _G = 1.2 I _{GT}	T _j = 25°C	MAX	60	mA
V _{TM}	I _{TM} = 24A t _p = 380μs	T _j = 25°C	MAX	1.5	V
I _{DRM}	V _D = V _{DRM}	T _j = 25°C	MAX	5	μA
I _{RRM}	V _R = V _{RRM}	T _j = 125°C	MAX	3	mA
dV/dt	V _D = 67%V _{DRM} Gate open	T _j = 125°C	MIN	200	V/μs

ORDERING INFORMATION Add "-TR" suffix for Tape & Reel shipment

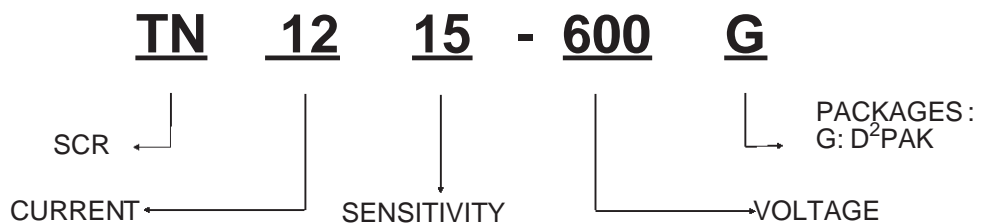

Fig. 1: Maximum average power dissipation versus average on-state current .

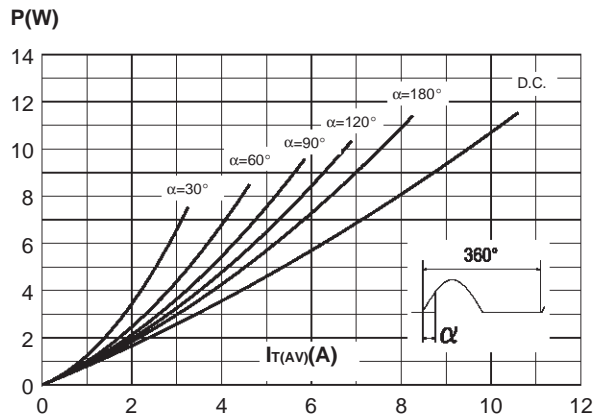

Fig. 2 : Correlation between maximum average power dissipation and maximum allowable temperatures (T_{amb} and T_{case}) for different thermal resistances heatsink+contact.

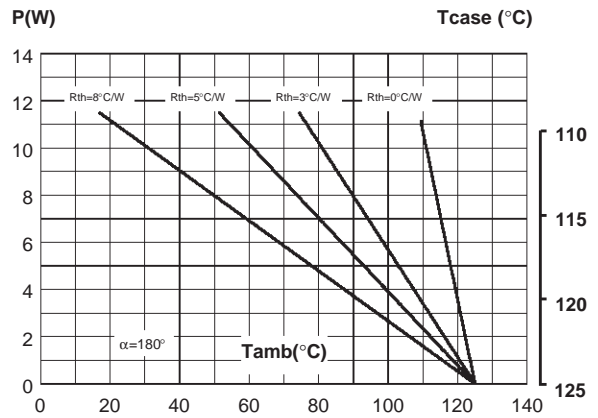

Fig. 3: Average and D.C. on-state current versus case temperature.

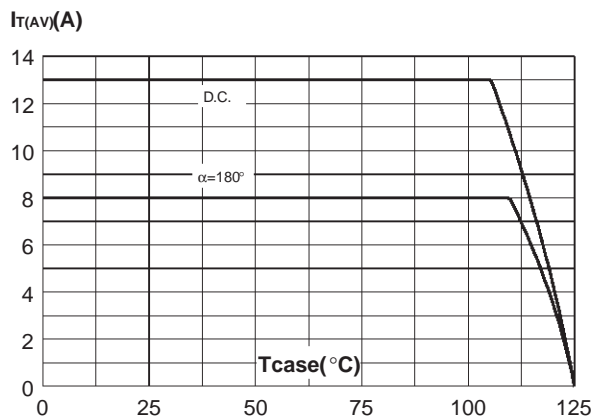

Fig. 4: Relative variation of thermal impedance versus pulse duration.

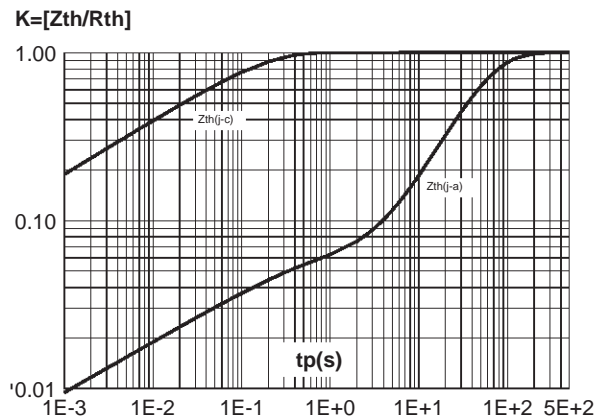

Fig. 5: Relative variation of gate trigger current and holding current versus junction temperature.

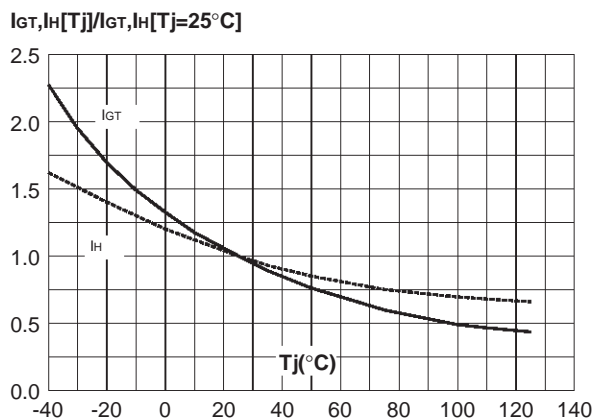

Fig. 6: Non repetitive surge peak on-state current versus number of cycles.

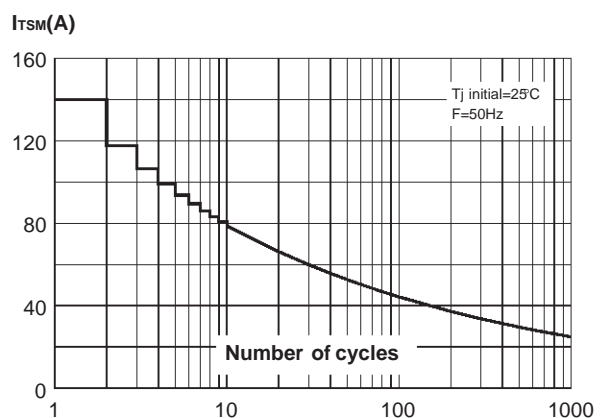

Fig. 7: Non repetitive surge peak on-state current for a sinusoidal pulse, with width $t_p < 10\text{ms}$, and corresponding value of I^2t .

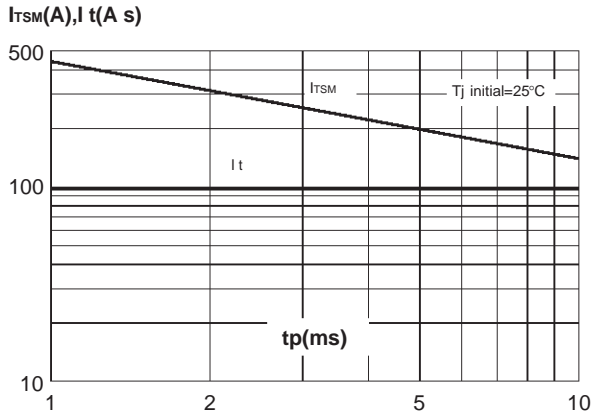

Fig. 9: Thermal resistance junction to ambient versus copper surface under tab (Epoxy printed circuit board FR4, copper thickness: $35\mu\text{m}$).

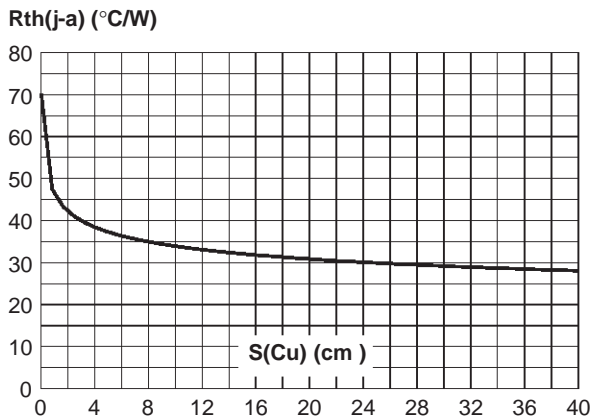

Fig. 8: On-state characteristics (maximum values).

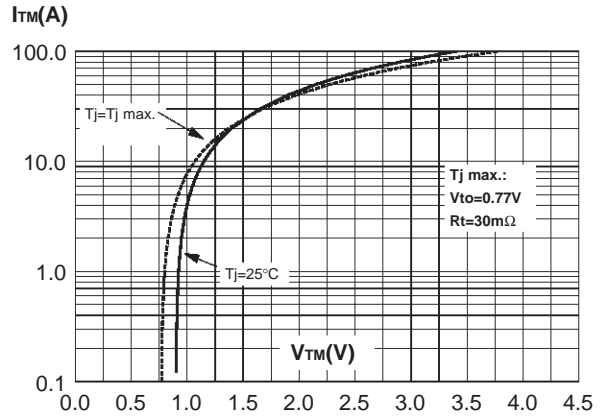
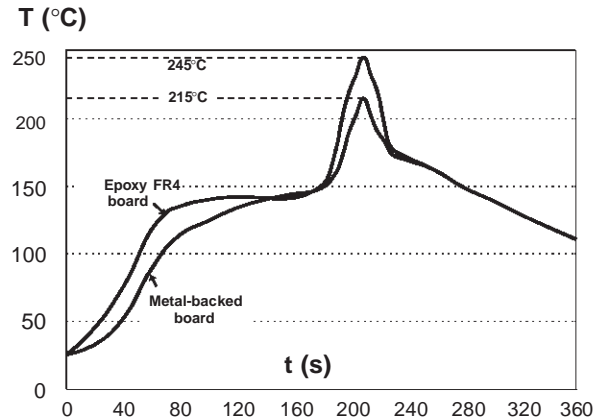
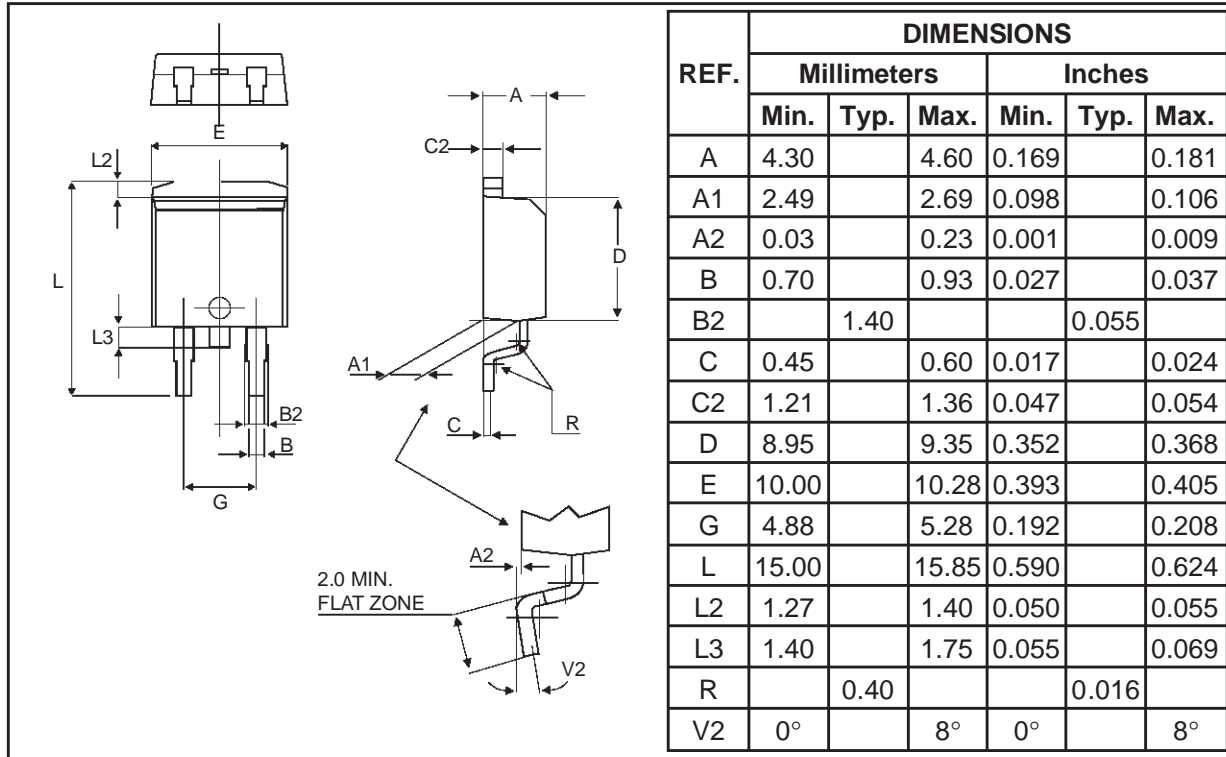

Fig. 10: Typical reflow soldering heat profile, either for mounting on FR4 or metal-backed boards.



PACKAGE MECHANICAL DATA
D²PAK



FOOT PRINT DIMENSIONS (in millimeters)

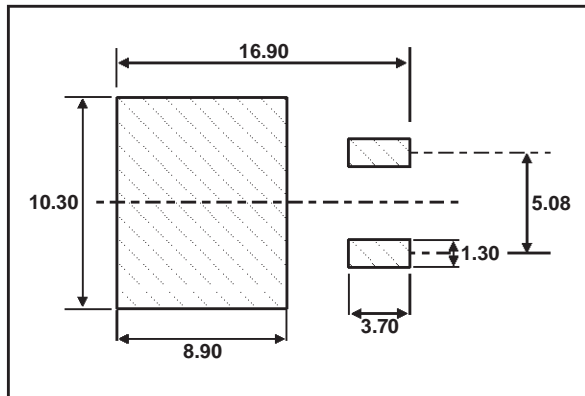

MARKING: TN1215
x00G

Information furnished is believed to be accurate and reliable. However, SGS-THOMSON Microelectronics assumes no responsibility for the consequences of use of such information nor for any infringement of patents or other rights of third parties which may result from its use. No license is granted by implication or otherwise under any patent or patent rights of SGS-THOMSON Microelectronics. Specifications mentioned in this publication are subject to change without notice. This publication supersedes and replaces all information previously supplied. SGS-THOMSON Microelectronics products are not authorized for use as critical components in life support devices or systems without express written approval of SGS-THOMSON Microelectronics.

© 1998 SGS-THOMSON Microelectronics - Printed in Italy - All rights reserved.

SGS-THOMSON Microelectronics GROUP OF COMPANIES

Australia - Brazil - Canada - China - France - Germany - Italy - Japan - Korea - Malaysia - Malta - Morocco

The Netherlands - Singapore - Spain - Sweden - Switzerland - Taiwan - Thailand - United Kingdom - U.S.A.