

Dual Supply Grand Earthing System Audio Signal Mute IC

FEATURES

- Wide Voltage Range (± 2.5 to ± 5.5 V)
- High Volume Attenuation (typ. -89dB)
- Very Low Signal Distortion (typ. 0.0025%)
- High Maximum Input Voltage (max. 5.2 V_{p-p})
- Very Low Standby Current (typ. 0.6 mA)
- Minimal External Component Circuitry

APPLICATIONS

- Audio Systems
- Television
- VTR
- MD
- CD

DESCRIPTION

The TK15125M is a dual power supply Mute IC of the Grand Earthing System that was developed as a low frequency signal attenuator for audio products.

The mute function includes two channels which operate simultaneously by one control key.

The optional time for the Attack/Release action can be set up by an external timing control capacitor.

The TK15125M is available in a SOP-14 Surface Mount Package.

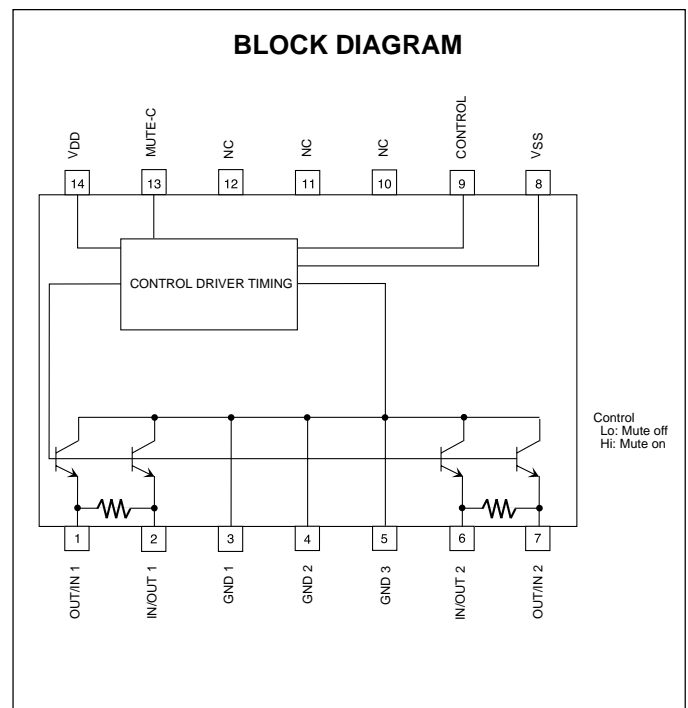
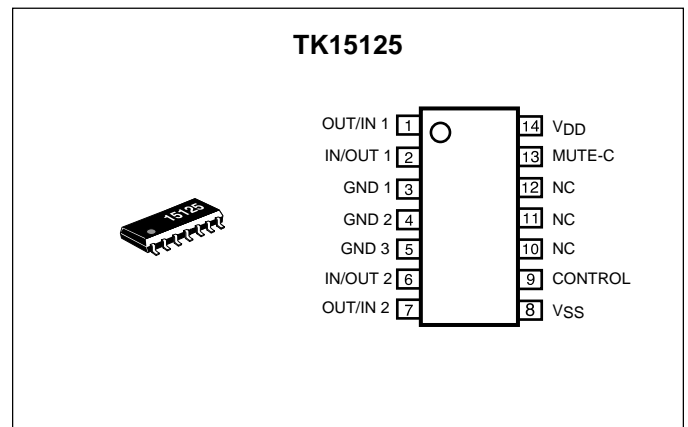

ORDERING INFORMATION

TK15125M □□

Tape/Reel Code

TAPE/REEL CODE
TL: Tape Left

TK15125

ABSOLUTE MAXIMUM RATINGS

Supply Voltage	±6 V	Storage Temperature Range	-55 to +150 °C
Power Dissipation (Note 3)	350 mW	Operating Temperature Range	-20 to +60 °C
Input Frequency	100 kHz	Signal Input Voltage	V_{SS} to V_{DD}

TK15121M ELECTRICAL CHARACTERISTICS

Test conditions: $V_{CC} = \pm 5$ V, $T_A = 25$ °C, $f = 1$ kHz, $V_{SIN} = 5$ V_{P-P} unless otherwise specified.

SYMBOL	PARAMETER	TEST CONDITIONS	MIN	TYP	MAX	UNITS
V_{DD}	Operating Voltage		2.5	5.0	5.5	V
V_{SS}			-2.5	-5.0	-5.5	V
$I_{DD(OFF)}$	Operating Current, Mute Off			0.6	0.9	mA
$I_{DD(ON)}$	Operating Current, Mute On			12.0	17.0	mA
ATT	Attenuation	$R_{IN} = 300 \Omega$ (Note 1)	-85	-89		dB
CI_{ON}	Mute On Charge Current		8.0	12.0	18.0	μA
CI_{OFF}	Mute Off Discharge Current	(Note 2)	1.8	3.0	5.0	μA
SWV_{OFF}	Mute Control SW, Mute Off Voltage		V_{SS}		$V_{SS} + 0.4$	V
SWV_{ON}	Mute Control SW, Mute On Voltage		$V_{SS} + 2.4$		V_{DD}	V
SWI_{ON}	Mute Control SW, Mute On Current			16	25	μA
V_{OSAT}	Mute On Output DC Voltage			2.4	3.7	mV
THD 1	Mute Off Total Harmonic Distortion			0.0025	0.0070	%
THD 2		JIS-A Filter ON		0.0007	0.0030	%
GVA	Voltage Gain	dB = ~20 kHz	-0.5	0	+0.5	dB
$V_{IN(MAX)}$	Maximum Input Voltage	THD < 0.01%			5.2	V _{P-P}
MR	Inner Attenuation Resistance		168	240	312	Ω

Note 1: If an R_{IN} other than 300 Ω is used, the volume attenuation and attack/release times change.

Note 2: In the standard application a capacitor is connected between Pin 13 and V_{SS} . Attack is the term used to describe the action of changing the unit from 'mute off' to 'mute on'. Release is the term used to describe the action of changing the unit from 'mute on' to 'mute off'. The standard timing control capacitance is 0.047 μF.

Note 3: Power dissipation is 350 mW when mounted as recommended. Derate at 2.8 mW/°C for operation above 25°C.

TEST CIRCUIT AND TESTING METHODS

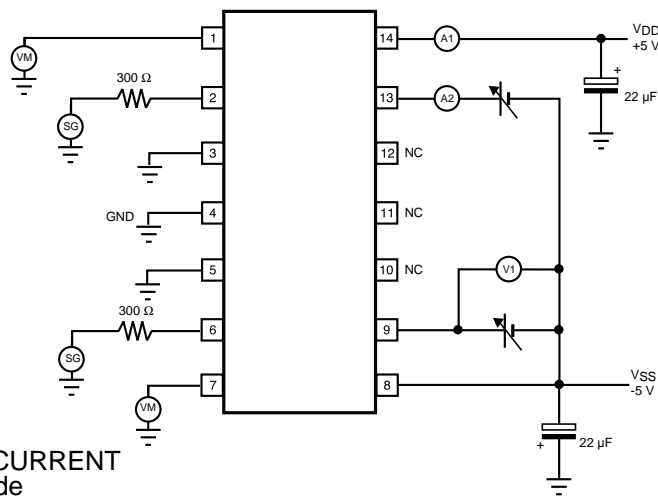

TESTING METHODS

1) POWER SUPPLY CURRENT

- 'MUTE OFF' Mode
Measure current 'A1' while control, Pin 9, is 'Lo' (or open).
- 'MUTE ON' Mode
Measure current 'A1' while control, Pin 9, is 'Hi'.

2) ATTENUATION VOLUME

- Attenuation is calculated by the following equation while control, Pin 9, is 'Hi':

$$ATT = 20\text{Log} \left(\frac{\text{Pin 1(Pin 7) output AC voltage}}{\text{Pin 2(Pin 6) input AC voltage}} \right)$$

3) CAPACITOR PIN CHARGING AND DISCHARGING CURRENT

- Charging Current
Measure outflow current 'A2' while control, Pin 9, is 'Hi' and the voltage at Pin 13 is $V_{SS} + 0.75\text{ V}$.
- Discharging Current
Measure inflow current 'A2' while control, Pin 9, is 'Lo (or open)' and the voltage at Pin 13 is $V_{SS} + 0.75\text{ V}$.

4) CONTROL SWITCH VOLTAGE

- 'MUTE OFF' Mode
Gradually elevate Pin 9 voltage above V_{SS} . When the Attack action (Mute On) is implemented at Pin 1 (Pin 7), measure the voltage 'V1'.
- 'MUTE ON' Mode
Gradually lower Pin 9 voltage below V_{DD} . When the Release action (Mute Off) is implemented at Pin 1 (Pin 7), measure the voltage 'V1'.

5) 'MUTE ON' OUTPUT DC VOLTAGE

- Measure output voltage at Pin 1 (Pin 7) while control, Pin 9, is 'Hi' and there is no input.

6) TOTAL HARMONIC DISTORTION

- Measure the distortion of the Pin 1 (Pin 7) output while control, Pin 9, is 'Lo' (or open).

7) SIGNAL VOLTAGE GAIN

- Signal gain is calculated by the following equation while control, Pin 9, is 'Lo' (or open).

$$GV = 20\text{Log} \left(\frac{\text{Pin 1(Pin 7) output AC voltage}}{\text{Pin 2(Pin 6) input AC voltage}} \right)$$

8) INNER ATTENUATION RESISTANCE

- Using a multimeter, measure the resistance between Pin 1 (Pin 7) and Pin 2 (Pin 6) while the power supply is off.

9) MAXIMUM INPUT SIGNAL VOLTAGE

- While control, Pin 9, is 'Lo' (or open), gradually elevate Pin 2 (Pin 6) voltage above 0 V_{p-p} . When the distortion becomes 0.01% at the output of Pin 1 (Pin 7), measure the AC voltage.

TYPICAL PERFORMANCE CHARACTERISTICS

$T_A = 25\text{ }^\circ\text{C}$, unless otherwise specified.

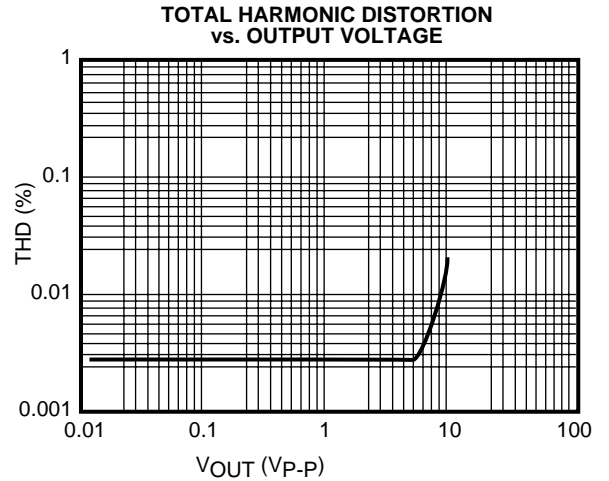
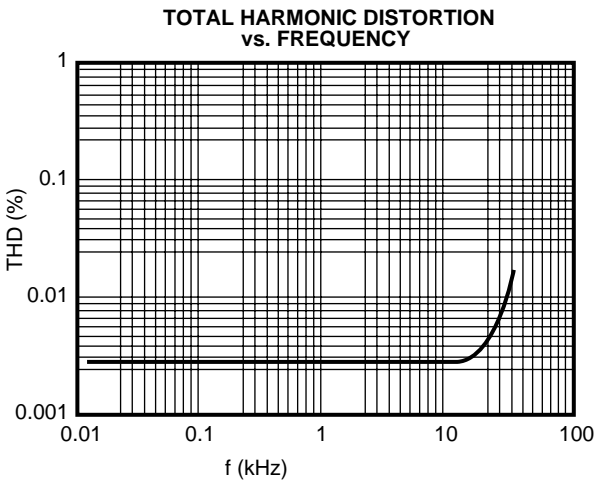
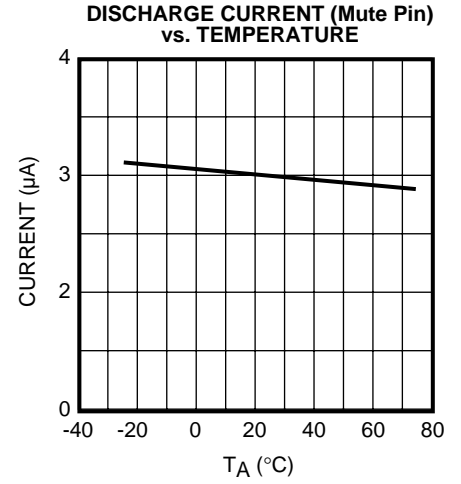
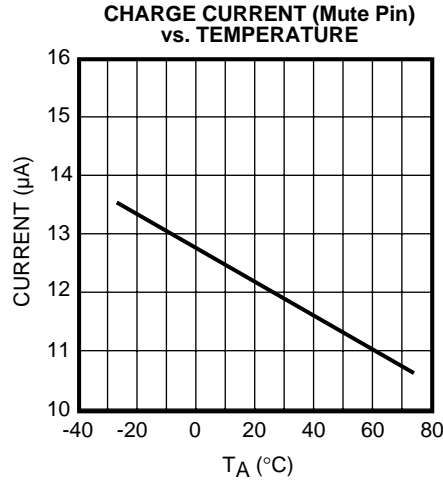
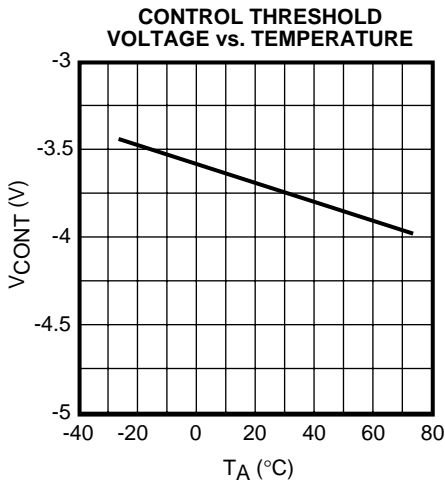
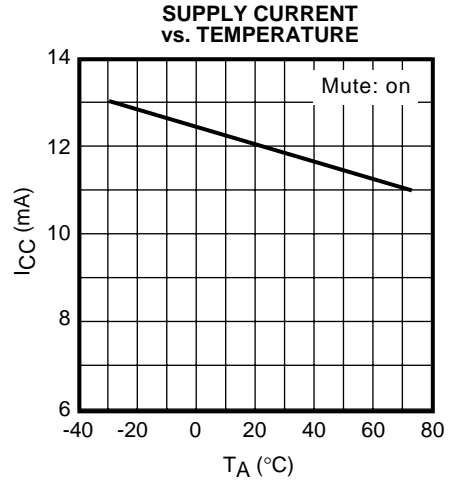
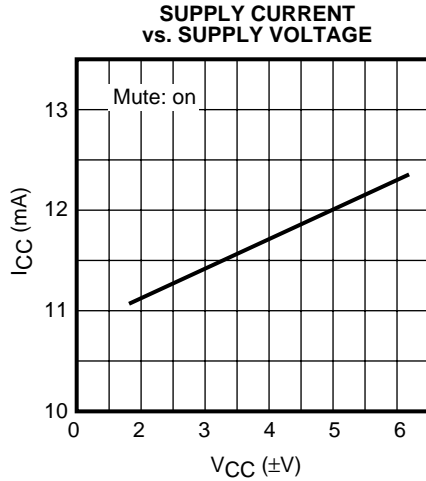
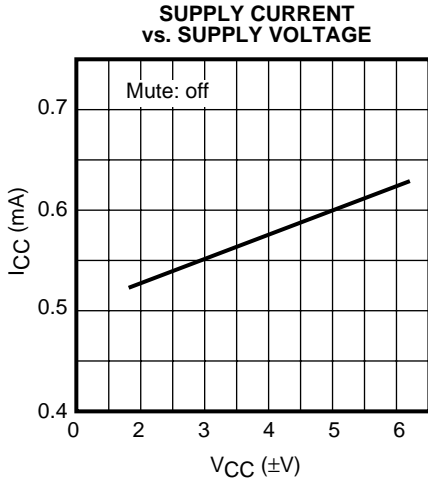

TYPICAL PERFORMANCE CHARACTERISTICS (CONT.)

$T_A = 25\text{ }^\circ\text{C}$, unless otherwise specified.

ATTENUATION VOLUME vs. FREQUENCY

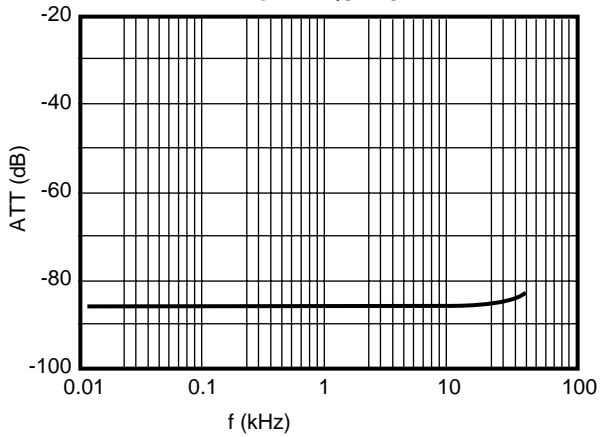

ATTENUATION VOLUME vs. MUTE RESISTANCE

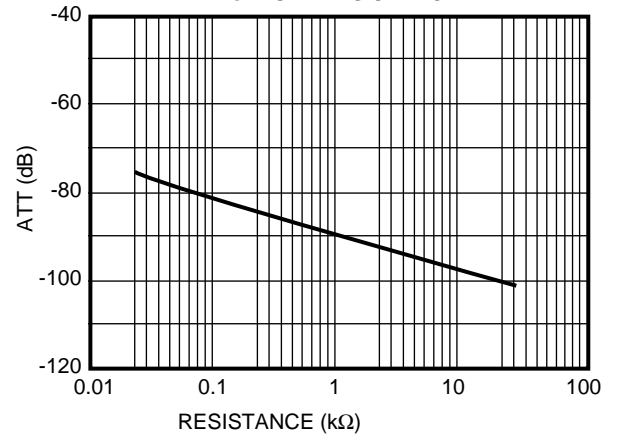

CROSS TALK vs. FREQUENCY

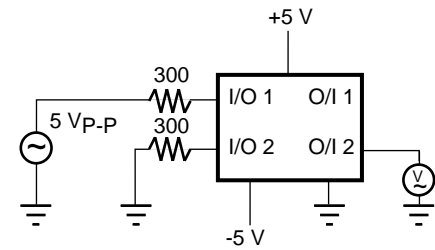
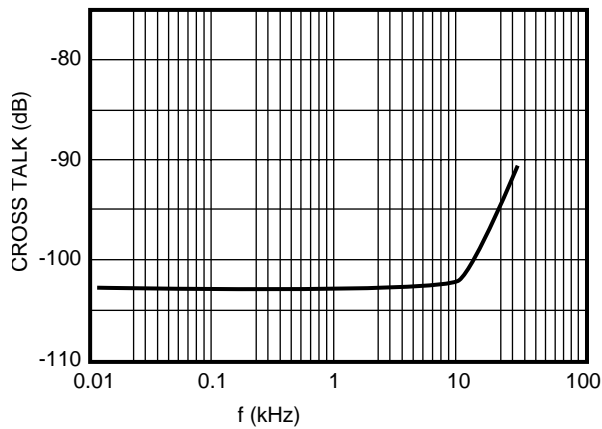

Cross Talk Test Circuit

STANDARD APPLICATION

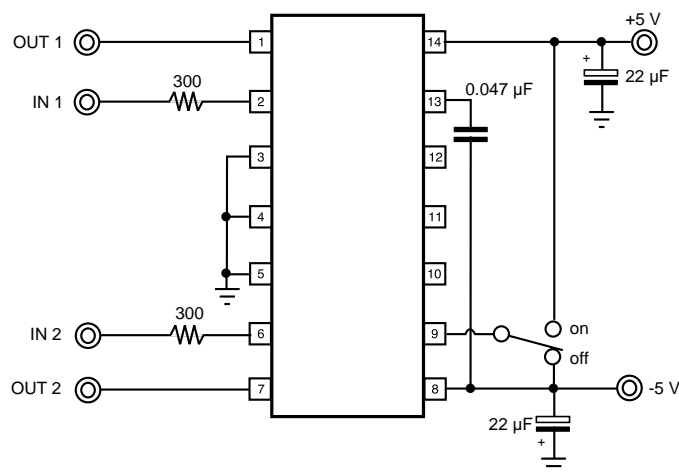

TERMINAL VOLTAGE AND EQUIVALENT CIRCUIT

PIN NO.	SYMBOL	DC VOLTAGE	EQUIVALENT CIRCUIT	EXPLANATION
1 2 6 7	OUT/IN 1 IN/OUT 1 IN/OUT 2 OUT/IN 2	Floating / 0 V Floating / 0 V Floating / 0 V Floating / 0 V		Pin 1: Output for Pin 2. Pin 2: Input for Pin 1. Pin 6: Input for Pin 7. Pin 7: Output for Pin 6. Note 1
3 4 5	GND 1 GND 2 GND 3	0 V 0 V 0 V	GND pin.	Ground pin. Note 2
8	V_{SS}	-5.5 ~ -2.5 V	V_{SS} pin.	Negative Voltage Pin.
9	Control	-5.0 V		Control Pin for the Mute on/off.
10 11 12	NC NC NC	Floating Floating Floating		No Connection Pin. Note 3
13	Mute-C	-5.0 V / 3.2 V		Pin for Timing Capacitor for Attack/Release time. Note 4
14	V_{DD}	2.5 ~ 5.5 V	V_{DD} Pin.	Positive Voltage Pin.

Note 1: Even if the input and output became opposite, the action is the same.

Note 2: Connect all GND pins to the Ground.

Note 3: Although all NC pins are not connected internally to the IC, signals should not be externally applied to these pins.

Note 4: In the standard application a capacitor is connected between Pin 13 and V_{SS} . Attack is the term used to describe the action of changing the unit from 'mute on' to 'mute off'.

The standard timing control capacitance is 0.047 μ F.

TIMING-CHART AND ACTION TIME AT MUTE

Test conditions: $V_{CC} = \pm 5 \text{ V}$, Timing Capacitor = $0.047 \mu\text{F}$

The following values are typical characteristics; accordingly they are not guaranteed values.

ATTACK ACTION START (MUTE ON)

When the attack action is started ('mute on' is initiated), the capacitor on Pin 13 starts to charge. The voltage at the capacitor on Pin 13 rises by 1.8 V. The 1.8 V rise time can be calculated by the following equation:

$$T_1 \approx \frac{\text{Capacitance} \times 1.8 \text{ V}}{\text{Charge Current}} = \frac{0.047 \mu\text{F} \times 1.8 \text{ V}}{12 \mu\text{A}} = 7.1 \text{ msec}$$

When the capacitor of Pin 13 rises by 1.8 V to -3.2 V as detected by the upper limit circuit, the mute action functions ($V_{SS} + 1.8 \text{ V} = -3.2 \text{ V}$). In this estimate, when the capacitor on Pin 13 has risen by 0.7 V to 0.8 V, the attenuation is approximately 90% of the final attenuation achieved. This results in the following calculation and timing chart.

$$T_2 \approx \frac{0.047 \mu\text{F} \times 0.75 \text{ V}}{12 \mu\text{A}}$$

$$= 2.9 \text{ msec}$$

This time is the attack time.

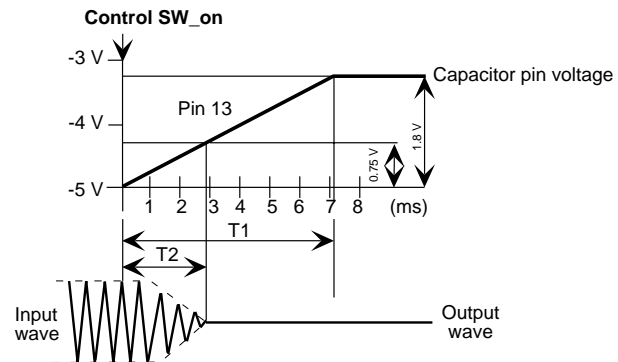

RELEASE ACTION START (MUTE OFF)

When the release action is started ('mute off' is initiated) the capacitor on Pin 13 starts to discharge. The voltage at the capacitor on Pin 13 falls to $V_{SS} + 10 \text{ mV}$. This fall time can be calculated by the following equation:

$$T_3 \approx \frac{\text{Capacitance} \times 1.8 \text{ V}}{\text{Discharge Current}} = \frac{0.047 \mu\text{F} \times 1.8 \text{ V}}{3 \mu\text{A}} = 28 \text{ msec}$$

In this estimate, when the capacitor on Pin 13 has fallen to $V_{SS} + 0.7 \text{ V}$ to 0.8 V , the signal is restored to approximately 90% of its value. This results in the following calculation and timing chart:

$$T_4 \approx \frac{0.047 \mu\text{F} \times 1.05 \text{ V}}{3 \mu\text{A}}$$

$$= 16 \text{ msec}$$

This time is the release time.

Accordingly, the release action time is 12 msec ($T_3 - T_4 = 28 \text{ msec} - 16 \text{ msec} = 12 \text{ msec}$).

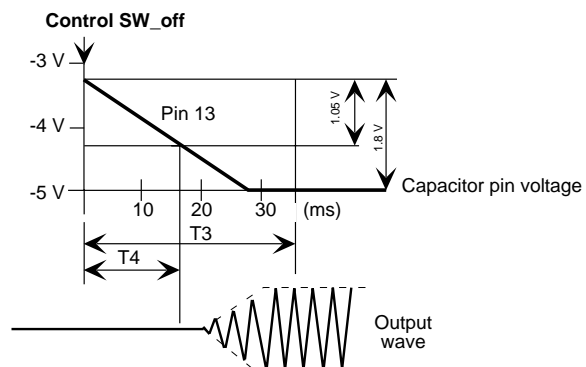

PACKAGE OUTLINE

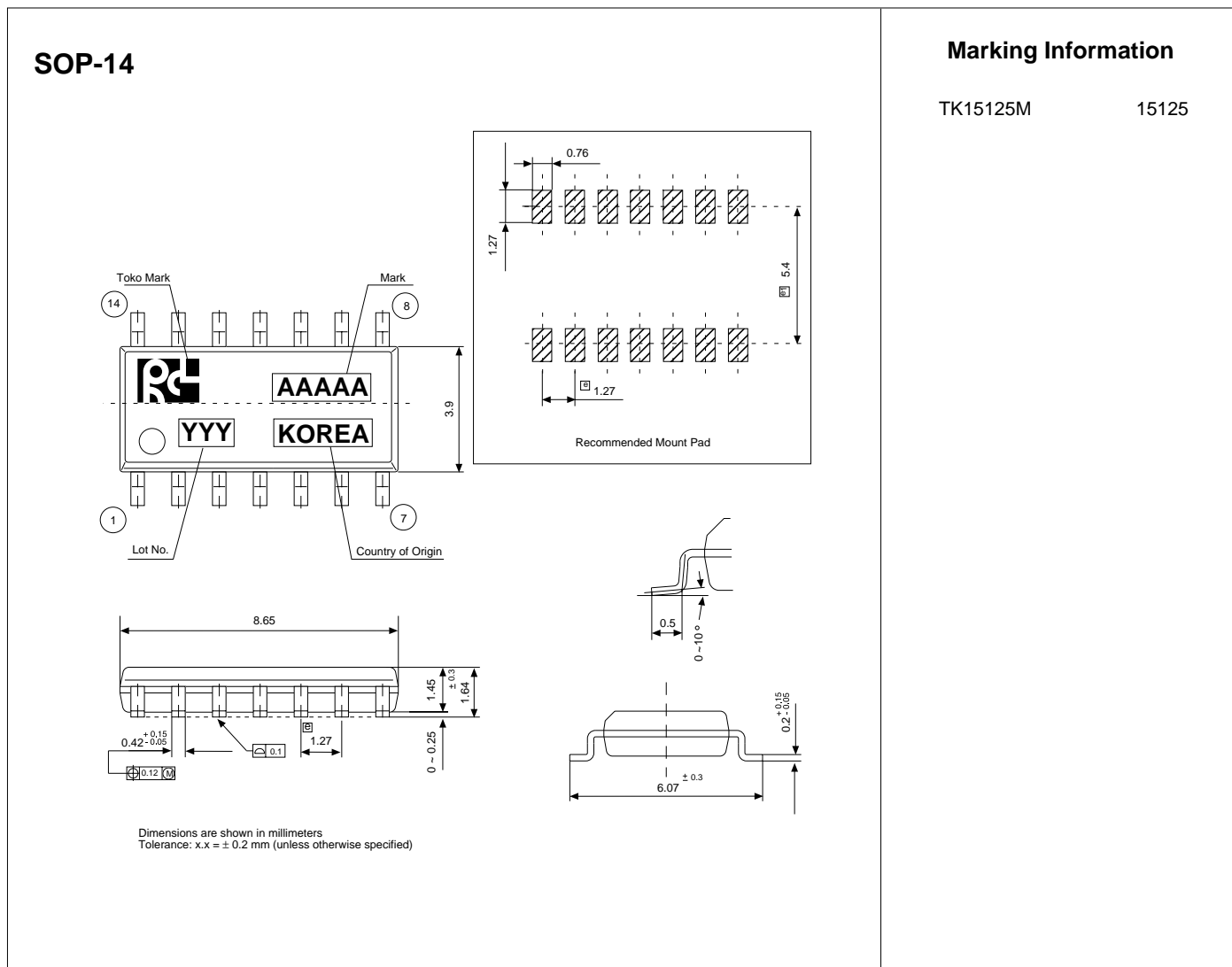

Toko America, Inc. Headquarters
 1250 Feehanville Drive, Mount Prospect, Illinois 60056
 Tel: (847) 297-0070 Fax: (847) 699-7864

TOKO AMERICA REGIONAL OFFICES

Midwest Regional Office
 Toko America, Inc.
 1250 Feehanville Drive
 Mount Prospect, IL 60056
 Tel: (847) 297-0070
 Fax: (847) 699-7864

Western Regional Office
 Toko America, Inc.
 2480 North First Street, Suite 260
 San Jose, CA 95131
 Tel: (408) 432-8281
 Fax: (408) 943-9790

Eastern Regional Office
 Toko America, Inc.
 107 Mill Plain Road
 Danbury, CT 06811
 Tel: (203) 748-6871
 Fax: (203) 797-1223

Semiconductor Technical Support
 Toko Design Center
 4755 Forge Road
 Colorado Springs, CO 80907
 Tel: (719) 528-2200
 Fax: (719) 528-2375

Visit our Internet site at <http://www.tokoam.com>

The information furnished by TOKO, Inc. is believed to be accurate and reliable. However, TOKO reserves the right to make changes or improvements in the design, specification or manufacture of its products without further notice. TOKO does not assume any liability arising from the application or use of any product or circuit described herein, nor for any infringements of patents or other rights of third parties which may result from the use of its products. No license is granted by implication or otherwise under any patent or patent rights of TOKO, Inc.