



# STP22NE10L

## N - CHANNEL 100V - 0.07 $\Omega$ - 22A TO-220 STripFET™ POWER MOSFET

TYPE	V <sub>DSS</sub>	R <sub>DS(on)</sub>	I <sub>D</sub>
STP22NE10L	100 V	< 0.085 $\Omega$	22 A

- TYPICAL R<sub>DS(on)</sub> = 0.07  $\Omega$
- LOW THRESHOLD DRIVE
- LOGIC LEVEL DEVICE

### DESCRIPTION

This Power MOSFET is the latest development of STMicroelectronics unique "Single Feature Size™" strip-based process. The resulting transistor shows extremely high packing density for low on-resistance, rugged avalanche characteristics and less critical alignment steps therefore a remarkable manufacturing reproducibility.

### APPLICATIONS

- HIGH CURRENT, HIGH SPEED SWITCHING
- SOLENOID AND RELAY DRIVERS
- MOTOR CONTROL, AUDIO AMPLIFIERS
- DC-DC & DC-AC CONVERTERS

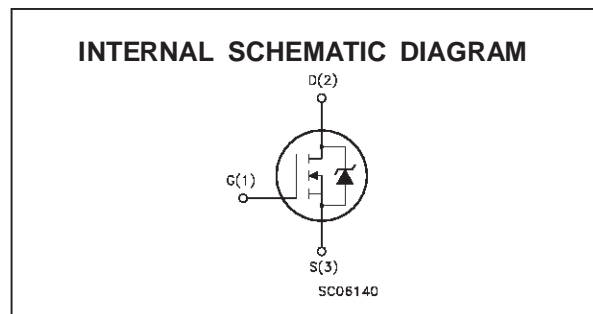
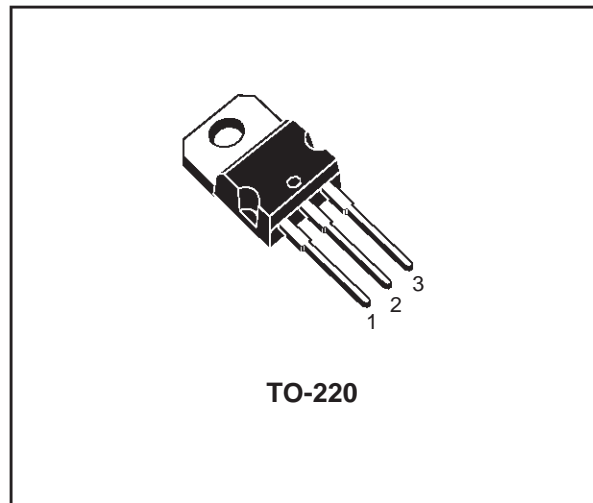

### ABSOLUTE MAXIMUM RATINGS

Symbol	Parameter	Value	Unit
V <sub>DS</sub>	Drain-source Voltage (V <sub>GS</sub> = 0)	100	V
V <sub>DGR</sub>	Drain- gate Voltage (R <sub>GS</sub> = 20 k $\Omega$ )	100	V
V <sub>GS</sub>	Gate-source Voltage	$\pm$ 20	V
I <sub>D</sub>	Drain Current (continuous) at T <sub>c</sub> = 25 °C	22	A
I <sub>D</sub>	Drain Current (continuous) at T <sub>c</sub> = 100 °C	14	A
I <sub>DM</sub> (●)	Drain Current (pulsed)	88	A
P <sub>tot</sub>	Total Dissipation at T <sub>c</sub> = 25 °C	90	W
	Derating Factor	0.6	W/°C
E <sub>AS</sub> (1)	Single Pulse Avalanche Energy	250	mJ
T <sub>stg</sub>	Storage Temperature	-65 to 175	°C
T <sub>j</sub>	Max. Operating Junction Temperature	175	°C

(●) Pulse width limited by safe operating area

(1) starting T<sub>j</sub> = 25 °C, I<sub>D</sub> = 22A, V<sub>DD</sub> = 50V

## STP22NE10L

### THERMAL DATA

$R_{thj-case}$	Thermal Resistance Junction-case	Max	1.67	$^{\circ}C/W$
$R_{thj-amb}$	Thermal Resistance Junction-ambient	Max	62.5	$^{\circ}C/W$
$T_l$	Maximum Lead Temperature For Soldering Purpose		300	$^{\circ}C$

### ELECTRICAL CHARACTERISTICS ( $T_{case} = 25^{\circ}C$ unless otherwise specified)

OFF

Symbol	Parameter	Test Conditions	Min.	Typ.	Max.	Unit
$V_{(BR)DSS}$	Drain-source Breakdown Voltage	$I_D = 250 \mu A$ $V_{GS} = 0$	100			V
$I_{DSS}$	Zero Gate Voltage Drain Current ( $V_{GS} = 0$ )	$V_{DS} = \text{Max Rating}$ $V_{DS} = \text{Max Rating}$ $T_c = 125^{\circ}C$			1 10	$\mu A$ $\mu A$
$I_{GSS}$	Gate-body Leakage Current ( $V_{DS} = 0$ )	$V_{GS} = \pm 20 V$			$\pm 100$	nA

ON (\*)

Symbol	Parameter	Test Conditions	Min.	Typ.	Max.	Unit
$V_{GS(th)}$	Gate Threshold Voltage	$V_{DS} = V_{GS}$ $I_D = 250 \mu A$	1	1.6	2.5	V
$R_{DS(on)}$	Static Drain-source On Resistance	$V_{GS} = 10 V$ $I_D = 15 A$ $V_{GS} = 5 V$ $I_D = 15 A$		0.07 0.085	0.085 0.1	$\Omega$ $\Omega$
$I_{D(on)}$	On State Drain Current	$V_{DS} > I_{D(on)} \times R_{DS(on)max}$ $V_{GS} = 10 V$	22			A

### DYNAMIC

Symbol	Parameter	Test Conditions	Min.	Typ.	Max.	Unit
$g_{fs} (*)$	Forward Transconductance	$V_{DS} > I_{D(on)} \times R_{DS(on)max}$ $I_D = 15 A$		19		S
$C_{iss}$	Input Capacitance	$V_{DS} = 25 V$ $f = 1 MHz$ $V_{GS} = 0$		1750		pF
$C_{oss}$	Output Capacitance			165		pF
$C_{rss}$	Reverse Transfer Capacitance			45		pF

**ELECTRICAL CHARACTERISTICS** (continued)

**SWITCHING ON**

Symbol	Parameter	Test Conditions	Min.	Typ.	Max.	Unit
$t_{d(on)}$	Turn-on Delay Time	$V_{DD} = 50\text{ V}$ $I_D = 8\text{ A}$ $R_G = 4.7\ \Omega$ $V_{GS} = 4.5\text{ V}$ (Resistive Load, see fig. 3)		40		ns
$t_r$	Rise Time			80		ns
$Q_g$	Total Gate Charge	$V_{DD} = 80\text{ V}$ $I_D = 16\text{ A}$ $V_{GS} = 10\text{ V}$		24	31	nC
$Q_{gs}$	Gate-Source Charge			55		nC
$Q_{gd}$	Gate-Drain Charge			11		nC

**SWITCHING OFF**

Symbol	Parameter	Test Conditions	Min.	Typ.	Max.	Unit
$t_{d(off)}$	Turn-off Delay Time	$V_{DD} = 50\text{ V}$ $I_D = 8\text{ A}$ $R_G = 4.7\ \Omega$ $V_{GS} = 4.5\text{ V}$ (Resistive Load, see fig. 3)		45		ns
$t_f$	Fall Time			12		ns
$t_{d(off)}$	Off-voltage Rise Time	$V_{clamp} = 80\text{ V}$ $I_D = 16\text{ A}$ $R_G = 4.7\ \Omega$ $V_{GS} = 4.5\text{ V}$ (Inductive Load, see fig. 5)		12		ns
$t_f$	Fall Time			17		ns
$t_c$	Cross-over Time			35		ns

**SOURCE DRAIN DIODE**

Symbol	Parameter	Test Conditions	Min.	Typ.	Max.	Unit
$I_{SD}$	Source-drain Current				22	A
$I_{SDM}(\bullet)$	Source-drain Current (pulsed)				88	A
$V_{SD}(\ast)$	Forward On Voltage	$I_{SD} = 16\text{ A}$ $V_{GS} = 0$			1.5	V
$t_{rr}$	Reverse Recovery Time	$I_{SD} = 16\text{ A}$ $di/dt = 100\text{ A}/\mu\text{s}$ $V_{DD} = 40\text{ V}$ $T_j = 150\text{ }^\circ\text{C}$ (see test circuit, fig. 5)		100		ns
$Q_{rr}$	Reverse Recovery Charge			300		nC
$I_{RRM}$	Reverse Recovery Current			6		A

(\*) Pulsed: Pulse duration = 300  $\mu\text{s}$ , duty cycle 1.5 %

(•) Pulse width limited by safe operating area

**Safe Operating Area**

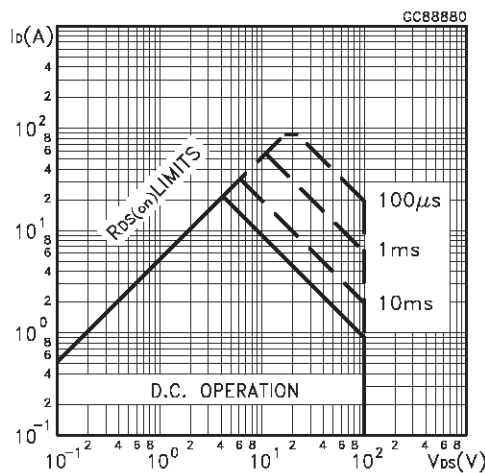

**Thermal Impedance**

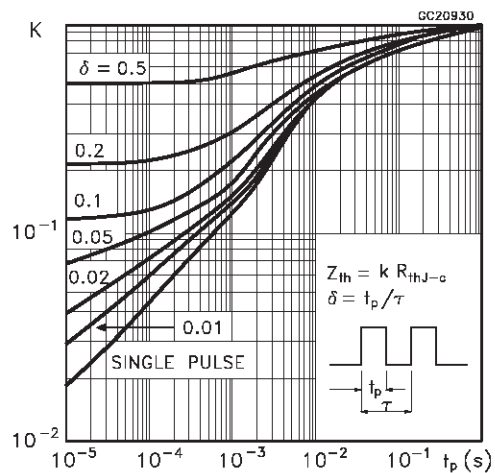

# STP22NE10L

## Output Characteristics

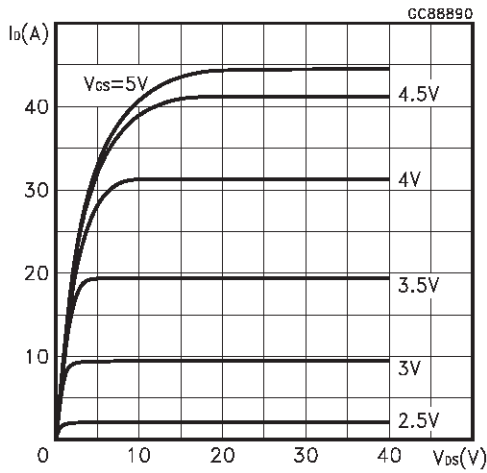

## Transfer Characteristics

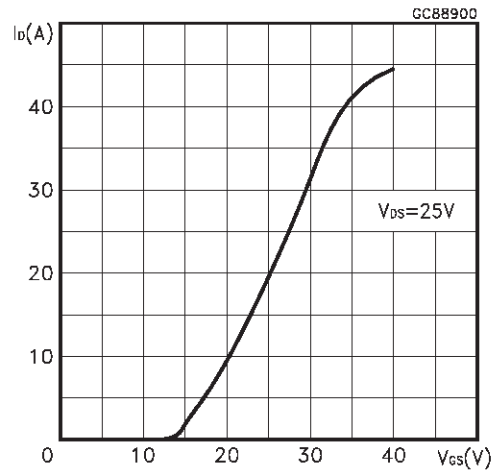

## Transconductance

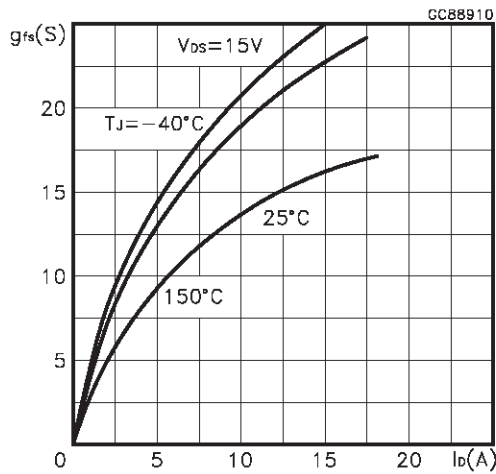

## Static Drain-source On Resistance

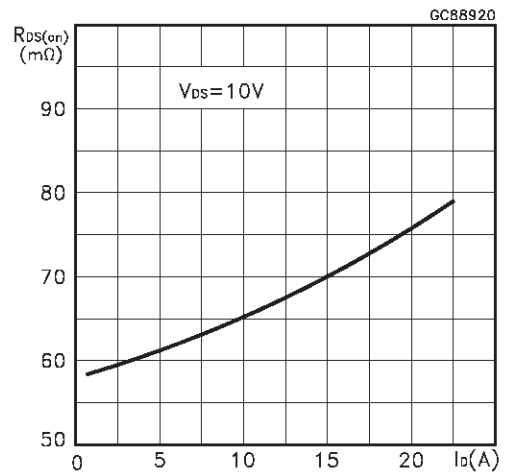

## Gate Charge vs Gate-source Voltage

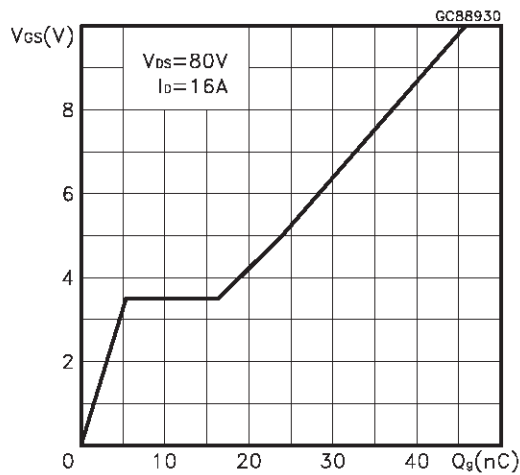

## Capacitance Variations

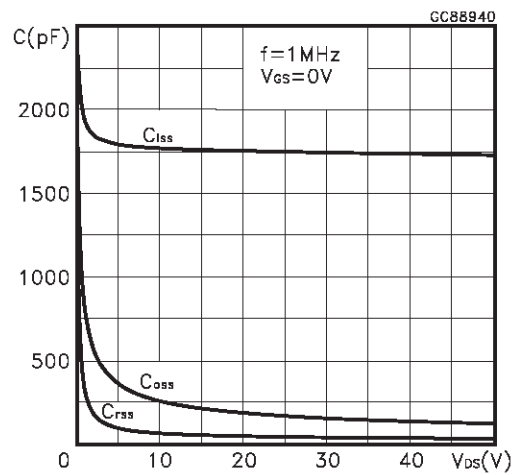

Normalized Gate Threshold Voltage vs Temperature

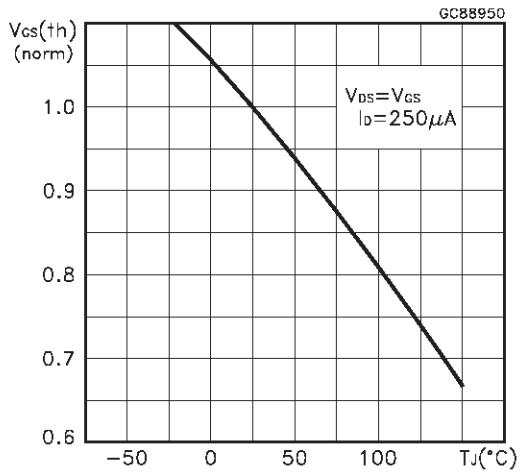

Normalized On Resistance vs Temperature

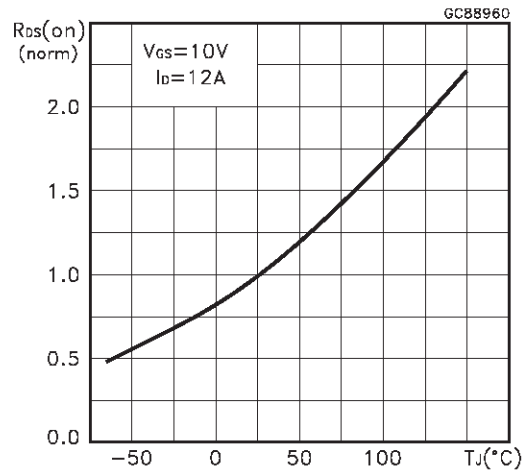

Source-drain Diode Forward Characteristics

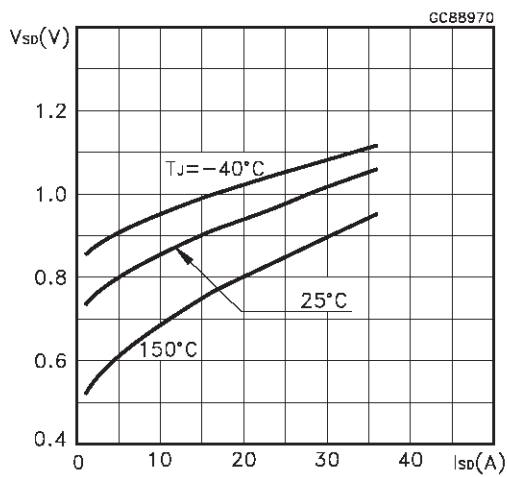

Fig. 1: Unclamped Inductive Load Test Circuit



Fig. 2: Unclamped Inductive Waveform

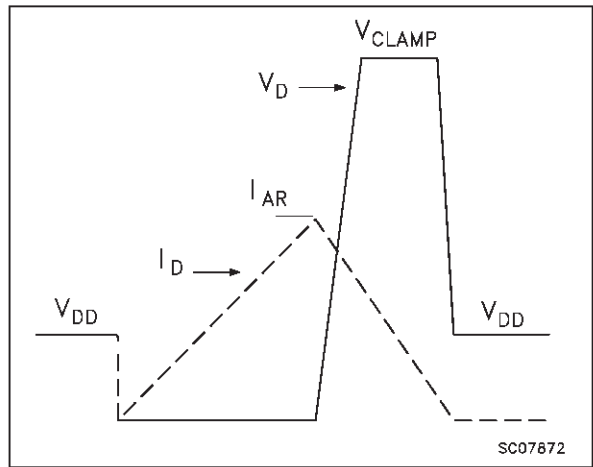

Fig. 3: Switching Times Test Circuits For Resistive Load



Fig. 4: Gate Charge test Circuit

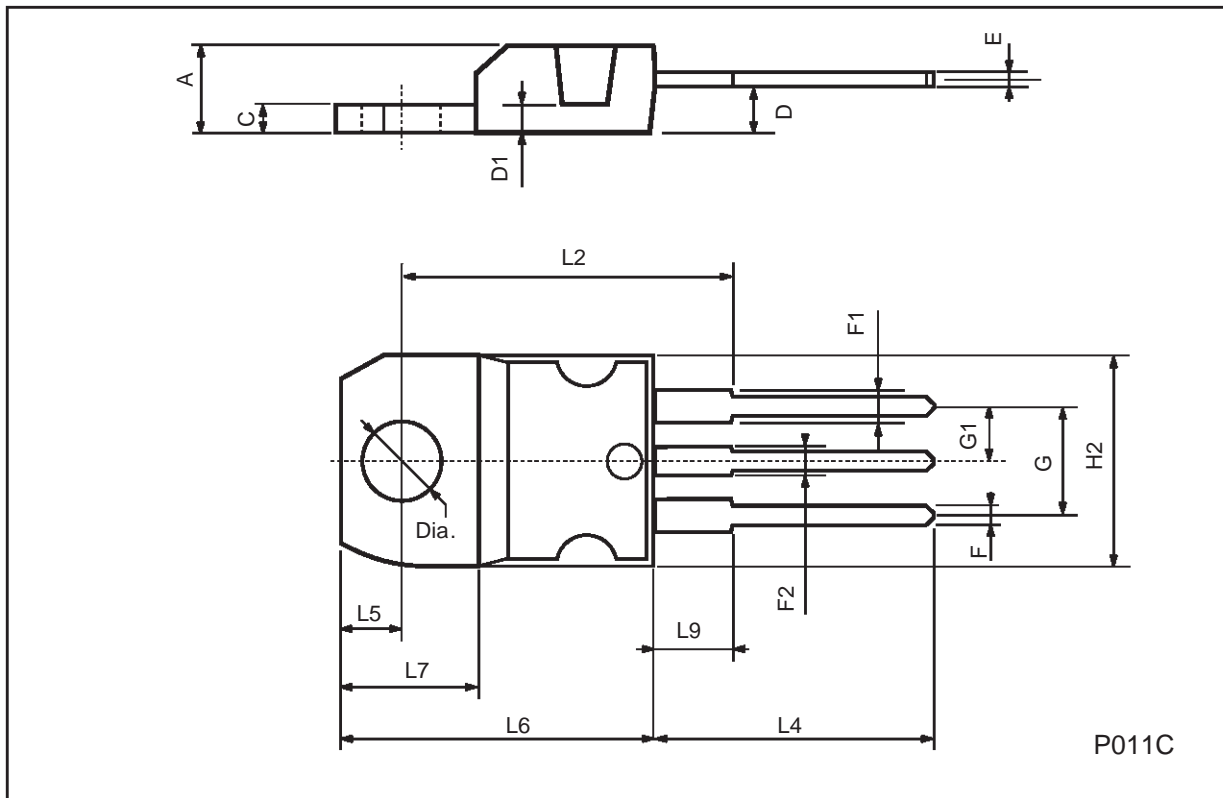

Fig. 5: Test Circuit For Inductive Load Switching And Diode Recovery Times



## TO-220 MECHANICAL DATA

DIM.	mm			inch		
	MIN.	TYP.	MAX.	MIN.	TYP.	MAX.
A	4.40		4.60	0.173		0.181
C	1.23		1.32	0.048		0.051
D	2.40		2.72	0.094		0.107
D1		1.27			0.050	
E	0.49		0.70	0.019		0.027
F	0.61		0.88	0.024		0.034
F1	1.14		1.70	0.044		0.067
F2	1.14		1.70	0.044		0.067
G	4.95		5.15	0.194		0.203
G1	2.4		2.7	0.094		0.106
H2	10.0		10.40	0.393		0.409
L2		16.4			0.645	
L4	13.0		14.0	0.511		0.551
L5	2.65		2.95	0.104		0.116
L6	15.25		15.75	0.600		0.620
L7	6.2		6.6	0.244		0.260
L9	3.5		3.93	0.137		0.154
DIA.	3.75		3.85	0.147		0.151



Information furnished is believed to be accurate and reliable. However, STMicroelectronics assumes no responsibility for the consequences of use of such information nor for any infringement of patents or other rights of third parties which may result from its use. No license is granted by implication or otherwise under any patent or patent rights of STMicroelectronics. Specification mentioned in this publication are subject to change without notice. This publication supersedes and replaces all information previously supplied. STMicroelectronics products are not authorized for use as critical components in life support devices or systems without express written approval of STMicroelectronics.

The ST logo is a trademark of STMicroelectronics

© 1999 STMicroelectronics – Printed in Italy – All Rights Reserved  
STMicroelectronics GROUP OF COMPANIES

Australia - Brazil - China - Finland - France - Germany - Hong Kong - India - Italy - Japan - Malaysia - Malta - Morocco -  
Singapore - Spain - Sweden - Switzerland - United Kingdom - U.S.A.