



T-39-05

N-Channel Enhancement-Mode Vertical DMOS Power FETs

Ordering Information

BV _{DSS} / BV _{DGS}	R _{DS(ON)} (max)	I _{D(ON)} (min)	Order Number / Package				
			TO-39	TO-92	TO-220	Quad P-DIP	Quad C-DIP
40V	2Ω	3.0A	VN0204N2	—	VN0204N5	VN0240N6	VN0204N7
60V	2Ω	3.0A	VN0206N2	VN0206N3	VN0206N5	VN0206N6	VN0206N7
100V	2Ω	3.0A	VN0210N2	VN0210N3	VN0210N5	—	—

Features

- Freedom from secondary breakdown
- Low power drive requirement
- Ease of paralleling
- Low C_{iss} and fast switching speeds
- Excellent thermal stability
- Integral Source-Drain diode
- High input impedance and high gain
- Complementary N- and P-Channel devices

Advanced DMOS Technology

These enhancement-mode (normally-off) power transistors utilize a vertical DMOS structure and Supertex's well-proven silicon-gate manufacturing process. This combination produces devices with the power handling capabilities of bipolar transistors and with the high input impedance and negative temperature coefficient inherent in MOS devices. Characteristic of all MOS structures, these devices are free from thermal runaway and thermally-induced secondary breakdown.

Supertex Vertical DMOS Power FETs are ideally suited to a wide range of switching and amplifying applications where high breakdown voltage, high input impedance, low input capacitance, and fast switching speeds are desired.

Applications

- Motor control
- Converters
- Amplifiers
- Switches
- Power supply circuits
- Drivers (Relays, Hammers, Solenoids, Lamps, Memories, Displays, Bipolar Transistors, etc.)

Package Options

(Notes 1 and 2)

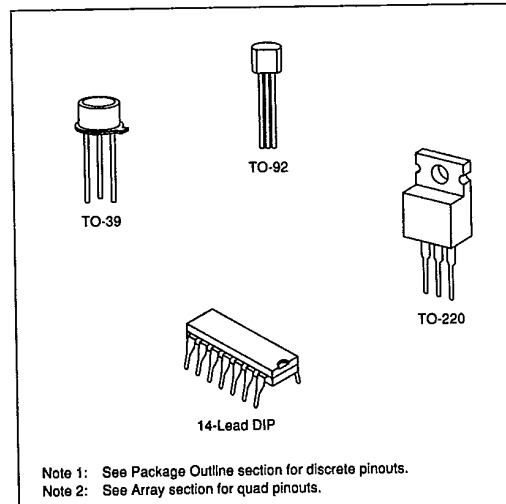

Note 1: See Package Outline section for discrete pinouts.
 Note 2: See Array section for quad pinouts.

Absolute Maximum Ratings

Drain-to-Source Voltage	BV _{DSS}
Drain-to-Gate Voltage	BV _{DGS}
Gate-to-Source Voltage	± 20V
Operating and Storage Temperature	-55°C to +150°C
Soldering Temperature*	300°C

*Distance of 1.6 mm from case for 10 seconds.

Thermal Characteristics

T-39-05

Package	I_D (continuous)*	I_D (pulsed)*	Power Dissipation @ $T_C = 25^\circ\text{C}$	θ_{JC} $^\circ\text{C/W}$	θ_{JA} $^\circ\text{C/W}$	I_{DR}	I_{DRM} *
TO-39	1.5A	4A	4W	25	125	2A	4A
TO-92	0.8A	4A	1W	125	170	0.8A	4A
TO-220	3.0A	4A	28W	4.8	70	3A	4A
Plastic Dip	Refer to Arrays and Special Functions section.						
Ceramic Dip							

* I_D (continuous) is limited by max rated T_J .

Electrical Characteristics (@ 25°C unless otherwise specified)

(Notes 1 and 2)

Symbol	Parameter	Min	Typ	Max	Unit	Conditions
BV_{DSS}	Drain-to-Source Breakdown Voltage	VN0204	40			$V_{GS} = 0, I_D = 2.5\text{mA}$
		VN0206	60			
		VN0210	100			
$V_{GS(th)}$	Gate Threshold Voltage	0.8		2.4	V	$V_{GS} = V_{DS}, I_D = 2.5\text{mA}$
$\Delta V_{GS(th)}$	Change in $V_{GS(th)}$ with Temperature		-3.8	-4.5	mV/ $^\circ\text{C}$	$V_{GS} = V_{DS}, I_D = 2.5\text{mA}$
I_{GSS}	Gate Body Leakage			100	nA	$V_{GS} = \pm 20\text{V}, V_{DS} = 0$
I_{DSS}	Zero Gate Voltage Drain Current			25	μA	$V_{GS} = 0, V_{DS} = \text{Max Rating}$
				1	mA	$V_{GS} = 0, V_{DS} = 0.8 \text{ Max Rating}$ $T_A = 125^\circ\text{C}$
$I_{D(ON)}$	ON-State Drain Current	1.2	1.6		A	$V_{GS} = 5\text{V}, V_{DS} = 25\text{V}$
		3.0	4.0			$V_{GS} = 10\text{V}, V_{DS} = 25\text{V}$
$R_{DS(ON)}$	Static Drain-to-Source ON-State Resistance		1.6	2.5	Ω	$V_{GS} = 5\text{V}, I_D = 1\text{A}$
			1.5	2		$V_{GS} = 10\text{V}, I_D = 2\text{A}$
$\Delta R_{DS(ON)}$	Change in $R_{DS(ON)}$ with Temperature		0.5	0.75	%/ $^\circ\text{C}$	$V_{GS} = 10\text{V}, I_D = 2\text{A}$
G_{FS}	Forward Transconductance	0.4	0.65		S	$V_{DS} = 25\text{V}, I_D = 2\text{A}$
C_{ISS}	Input Capacitance		85	150	pF	$V_{GS} = 0, V_{DS} = 25\text{V}$ $f = 1 \text{ MHz}$
C_{OSS}	Common Source Output Capacitance		50	85		
C_{RSS}	Reverse Transfer Capacitance		12	35		
$t_{d(ON)}$	Turn-ON Delay Time			10	ns	$V_{DD} = 25\text{V}$ $I_D = 0.5\text{A}$ $R_S = 50\Omega$
t_r	Rise Time			10		
$t_{d(OFF)}$	Turn-OFF Delay Time			25		
t_f	Fall Time			13		
V_{SD}	Diode Forward Voltage Drop		1.2	1.8		
t_{rr}	Reverse Recovery Time		330		ns	$V_{GS} = 0, I_{SD} = 1\text{A}$

Note 1: All D.C. parameters 100% tested at 25°C unless otherwise stated. (Pulse test: 300 μs pulse, 2% duty cycle.)

Note 2: All A.C. parameters sample tested.

Switching Waveforms and Test Circuit

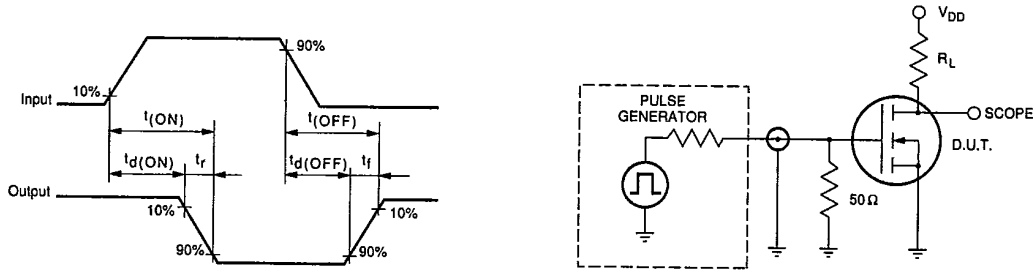

Typical Performance Curves

T-39-05

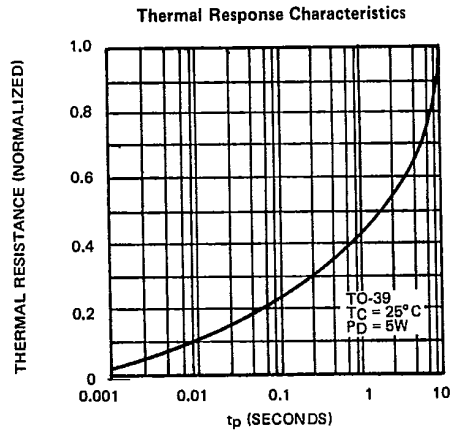
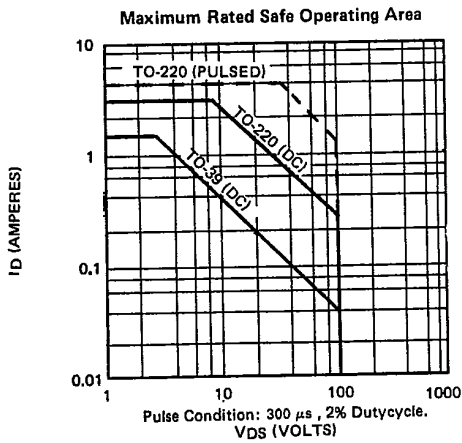
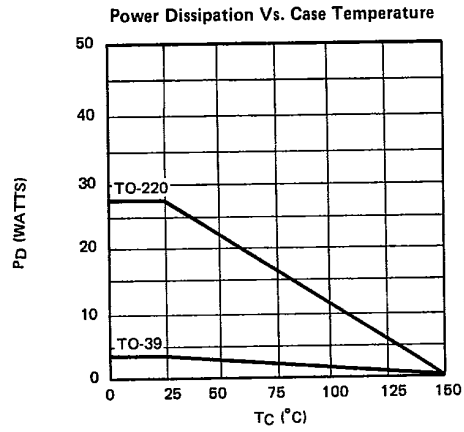
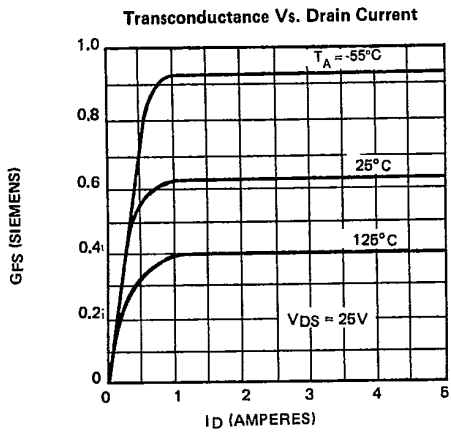
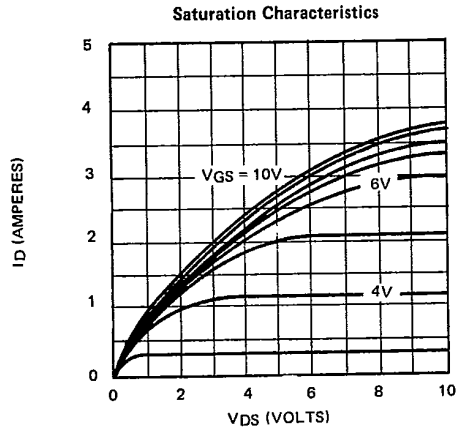
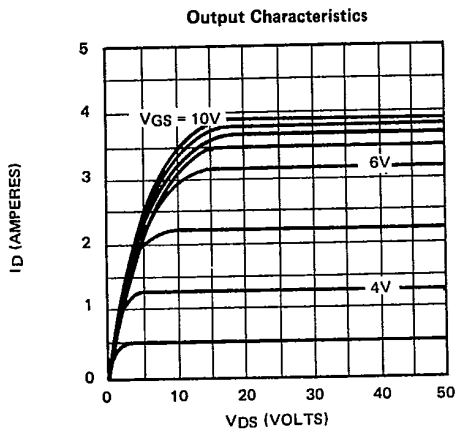

8

T-39-05

