



Manifold Absolute Pressure Sensors On-Chip Signal Conditioned, 0.25 V to 4.9 V Output, Temperature Compensated and Calibrated

The Motorola MPXT4100A/4101A/4105A series Manifold Absolute Pressure (MAP) sensor for engine control is designed to sense absolute air pressure within the intake manifold. This measurement can be used to compute the amount of fuel required for each cylinder. The small form factor and high reliability of on-chip integration makes the Motorola MAP sensor a logical and economical choice for automotive system designers.

Features

- 1.8% Maximum Error Over 0° to 85°C
- Specifically Designed for Intake Manifold Absolute Pressure Sensing in Engine Control Systems
- Ideally Suited for Microprocessor Interfacing
- Patented Silicon Shear Stress Strain Gauge
- Temperature Compensated Over -40°C to +125°C
- Surface Mount Package
- Ideal for Non-Automotive Applications
- Also Available in Unibody Package

Application Examples

- Manifold Sensing for Automotive Systems

MAXIMUM RATINGS (T_C = 25°C unless otherwise noted)

| Rating | Symbol | Value | Unit |
|---|--------------------|-------------|------|
| Overpressure ⁽¹⁾ (P1 > P2) | P _{max} | 400 | kPa |
| Burst Pressure ⁽¹⁾ (P1 > P2) | P _{burst} | 1000 | kPa |
| Storage Temperature | T _{stg} | -40 to +125 | °C |
| Operating Temperature | T _A | -40 to +125 | °C |

MPXT4100 MPXT4101 MPXT4105 SERIES

4100A: 20–105 kPa
4101A: 15–102 kPa
4105A: 15–105 kPa
X-ducer™
SILICON
PRESSURE SENSORS

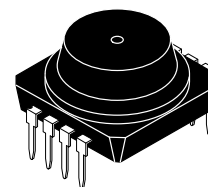

**BASIC ELEMENT
CASE 473A-01, STYLE 2**

PIN NUMBER

| | | | |
|---|-------------------|---|-----|
| 1 | Gnd | 5 | N/C |
| 2 | +V _{out} | 6 | N/C |
| 3 | V _S | 7 | N/C |
| 4 | -V _{out} | 8 | N/C |

NOTE: Pins 5, 6, 7, and 8 are not device connections. Do not connect to external circuitry or ground. Pin 1 is noted by the notch in the Lead.

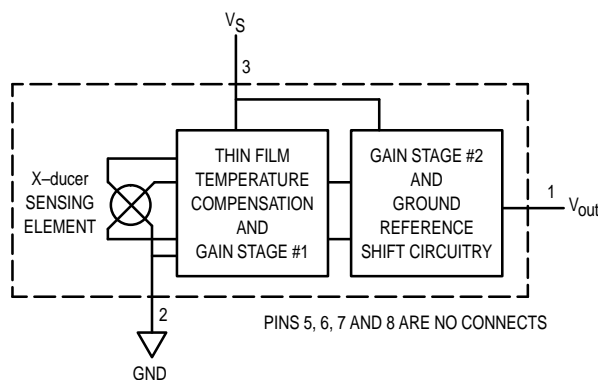

Figure 1. Fully Integrated Pressure Sensor Schematic

The MPXT4100A/4101A/4105A series piezoresistive transducer is a state-of-the-art, monolithic, signal conditioned, silicon pressure sensor. This sensor, with its patented transducer, combines advanced micromachining techniques, thin film metallization, and bipolar semiconductor processing to provide an accurate, high level analog output signal that is proportional to applied pressure.

Figure 1 shows a block diagram of the internal circuitry integrated on a pressure sensor chip.

Senseon and X-ducer are trademarks of Motorola, Inc.

MPXT4100 MPXT4101 MPXT4105 SERIES

MPXT4100A SERIES OPERATING CHARACTERISTICS ($V_S = 5.1$ Vdc, $T_A = 25^\circ\text{C}$ unless otherwise noted, $P_1 > P_2$)

| Characteristic | Symbol | Min | Typ | Max | Unit |
|--|---------------------|-------|-------|-------|-------------|
| Pressure Range | P_{OP} | 20 | — | 105 | kPa |
| Supply Voltage ⁽²⁾ | V_S | 4.85 | 5.1 | 5.35 | Vdc |
| Supply Current | I_o | — | 7.0 | 10 | mAdc |
| Offset ⁽³⁾ (0 to 85°C) | V_{off} | 0.225 | 0.306 | 0.388 | V |
| Full Scale Output ⁽⁴⁾ (0 to 85°C) | V_{FSO} | 4.816 | 4.897 | 4.978 | Vdc |
| Full Scale Span ⁽⁵⁾ (0 to 85°C) | V_{FSS} | 4.510 | 4.591 | 4.672 | V |
| Accuracy ⁽⁶⁾ (0 to 85°C) | — | — | — | ±1.8 | % V_{FSS} |
| Sensitivity | $\Delta V/\Delta P$ | — | 54 | — | mV/kPa |
| Response Time ⁽⁷⁾ | t_R | — | 1.0 | — | ms |
| Output Source Current at Full Scale Output | I_{o+} | — | 0.1 | — | mA |

MECHANICAL CHARACTERISTICS

| Characteristic | Symbol | Min | Typ | Max | Unit |
|---|--------|-----|-----|-------|-----------------|
| Weight, Basic Element (Case 473) | — | — | 2.0 | — | Grams |
| Warm-Up Time ⁽⁸⁾ | — | — | 15 | — | mSec |
| Cavity Volume | — | — | — | 0.01 | IN ³ |
| Volumetric Displacement | — | — | — | 0.001 | IN ³ |
| Common Mode Line Pressure ⁽¹¹⁾ | — | — | — | 690 | kPa |

MPXT4101A SERIES OPERATING CHARACTERISTICS ($V_S = 5.1$ Vdc, $T_A = 25^\circ\text{C}$ unless otherwise noted, $P_1 > P_2$)

| Characteristic | Symbol | Min | Typ | Max | Unit |
|--|---------------------|-------|-------|-------|-------------|
| Pressure Range | P_{OP} | 15 | — | 102 | kPa |
| Supply Voltage ⁽²⁾ | V_S | 4.85 | 5.1 | 5.35 | Vdc |
| Supply Current | I_o | — | 7.0 | 10 | mAdc |
| Offset ⁽³⁾ (0 to 85°C) | V_{off} | 0.171 | 0.252 | 0.333 | V |
| Full Scale Output ⁽⁴⁾ (0 to 85°C) | V_{FSO} | 4.870 | 4.951 | 5.032 | Vdc |
| Full Scale Span ⁽⁵⁾ (0 to 85°C) | V_{FSS} | 4.618 | 4.700 | 4.782 | V |
| Accuracy ⁽⁶⁾ (0 to 85°C) | — | — | — | ±1.8 | % V_{FSS} |
| Sensitivity | $\Delta V/\Delta P$ | — | 54 | — | mV/kPa |
| Response Time ⁽⁷⁾ | t_R | — | 1.0 | — | ms |
| Output Source Current at Full Scale Output | I_{o+} | — | 0.1 | — | mA |

MECHANICAL CHARACTERISTICS

| Characteristic | Symbol | Min | Typ | Max | Unit |
|---|--------|-----|-----|-------|-----------------|
| Weight, Basic Element (Case 473) | — | — | 2.0 | — | Grams |
| Warm-Up Time ⁽⁸⁾ | — | — | 15 | — | mSec |
| Cavity Volume | — | — | — | 0.01 | IN ³ |
| Volumetric Displacement | — | — | — | 0.001 | IN ³ |
| Common Mode Line Pressure ⁽¹¹⁾ | — | — | — | 690 | kPa |

MPXT4105A SERIES OPERATING CHARACTERISTICS ($V_S = 5.1 \text{ Vdc}$, $T_A = 25^\circ\text{C}$ unless otherwise noted)

| Characteristic | Symbol | Min | Typ | Max | Unit |
|--|---------------------|-------|--------|-------|-------------|
| Pressure Range | P_{OP} | 15 | — | 105 | kPa |
| Supply Voltage ⁽²⁾ | V_S | 4.85 | 5.1 | 5.35 | Vdc |
| Supply Current | I_o | — | 7.0 | 10 | mAdc |
| Offset ⁽³⁾ (0 to 85°C) | V_{off} | 0.184 | 0.306 | 0.428 | Vdc |
| Full Scale Output ⁽⁴⁾ (0 to 85°C) | V_{FSO} | 4.804 | 4.896 | 4.988 | Vdc |
| Full Scale Span ⁽⁵⁾ (0 to 85°C) | V_{FSS} | — | 4.590 | — | Vdc |
| Accuracy ⁽⁶⁾ (0 to 85°C) | — | — | — | ± 1.8 | % V_{FSS} |
| Sensitivity | $\Delta V/\Delta P$ | — | 51 | — | mV/kPa |
| Response Time ⁽⁷⁾ | t_R | — | 1.0 | — | ms |
| Output Source Current at Full Scale Output | I_{o+} | — | 0.1 | — | mAdc |
| Offset Stability ⁽⁹⁾ | — | — | ± 0.65 | — | % V_{FSS} |

MECHANICAL CHARACTERISTICS

| Characteristic | Symbol | Min | Typ | Max | Unit |
|---|--------|-----|-----|-------|-----------------|
| Weight, Basic Element (Case 473) | — | — | 2.0 | — | Grams |
| Warm-Up Time ⁽⁸⁾ | — | — | 15 | — | mSec |
| Cavity Volume | — | — | — | 0.01 | IN ³ |
| Volumetric Displacement | — | — | — | 0.001 | IN ³ |
| Common Mode Line Pressure ⁽¹¹⁾ | — | — | — | 690 | kPa |

NOTES:

- Exposure beyond the specified limits may cause permanent damage or degradation to the device.
- Device is ratiometric within this specified excitation range.
- Offset (V_{off}) is defined as the output voltage at the minimum rated pressure.
- Full Scale Output (V_{FSO}) is defined as the output voltage at the maximum or full rated pressure.
- Full Scale Span (V_{FSS}) is defined as the algebraic difference between the output voltage at full rated pressure and the output voltage at the minimum rated pressure.
- Accuracy is the deviation in actual output from nominal output over the entire pressure range and temperature range as a percent of span at 25°C due to all sources of error including the following:
 - Linearity: Output deviation from a straight line relationship with pressure over the specified pressure range.
 - Temperature Hysteresis: Output deviation at any temperature within the operating temperature range, after the temperature is cycled to and from the minimum or maximum operating temperature points, with minimum specified pressure applied.
 - Pressure Hysteresis: Output deviation at any pressure within the specified range, when this pressure is cycled to and from minimum or maximum rated pressure at 25°C.
 - TcSpan: Span deviation per °C over the temperature range of 0° to 85°C, as a percent of span at 25°C.
 - TcOffset: Output deviation per °C with minimum pressure applied, over the temperature range of 0° to 85°C.
- Response Time is defined as the time for the incremental change in the output to go from 10% to 90% of its final value when subjected to a specified step change in pressure.
- Warm-up Time is defined as the time required for the product to meet the specified output voltage.
- Offset Stability is the product's output deviation when subjected to 1000 hours of Pulsed Pressure, Temperature Cycling with Bias Test.
- Decoupling circuit shown in Figure 3 required to meet specification.
- Common mode pressures beyond specified may result in leakage at the case-to-lead interface.

MPXT4100 MPXT4101 MPXT4105 SERIES

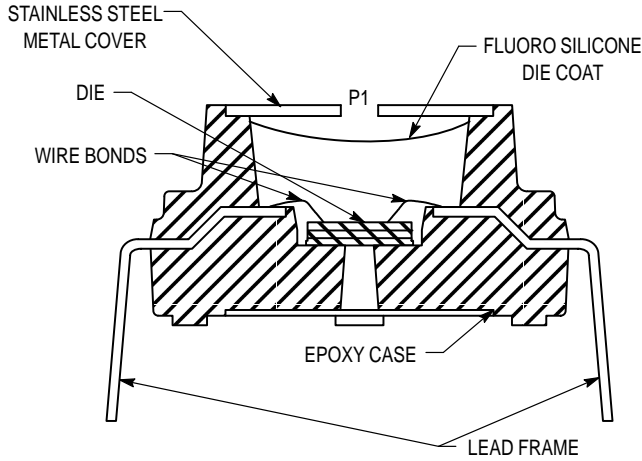

Figure 2. Cross Sectional Diagram (Not to Scale)

Figure 2 illustrates an absolute sensing chip in the basic chip carrier (Case 473). A fluorosilicone gel isolates the die surface and wire bonds from the environment, while allowing the pressure signal to be transmitted to the sensor diaphragm. The MPXT4100A/4101A/4105A series pressure sensor operating characteristics, and internal reliability and qualification tests are based on use of dry air as the pressure media. Media, other than dry air, may have adverse effects on sensor performance and long-term reliability. Contact the factory for information regarding media compatibility in your application.

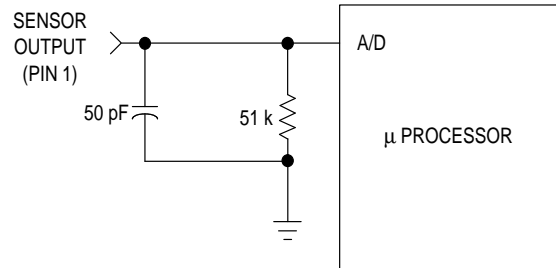

Figure 3. Decoupling Filter for Sensor to Microprocessor Interface

Figure 3 shows a typical decoupling circuit for interfacing the integrated MAP sensor to the A/D input of a microprocessor. Proper decoupling of the power supply is recommended.

Figures 4, 5, and 6 show the sensor output signal relative to pressure input. Typical, minimum, and maximum output curves are shown for operation over a temperature range of 0° to 85°C. (The output will saturate outside of the specified pressure range.)

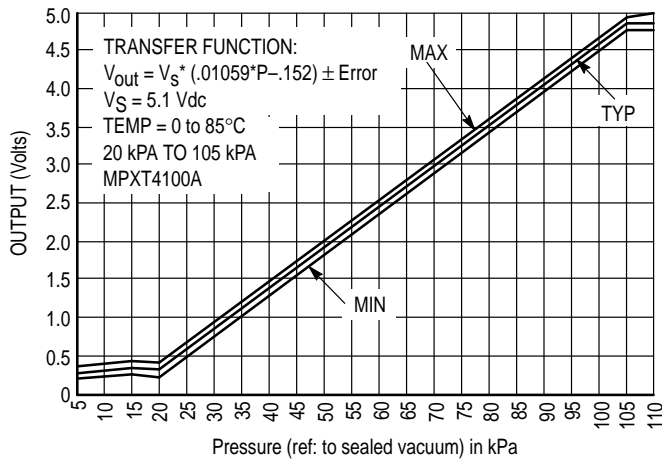

Figure 4. Output versus Absolute Pressure

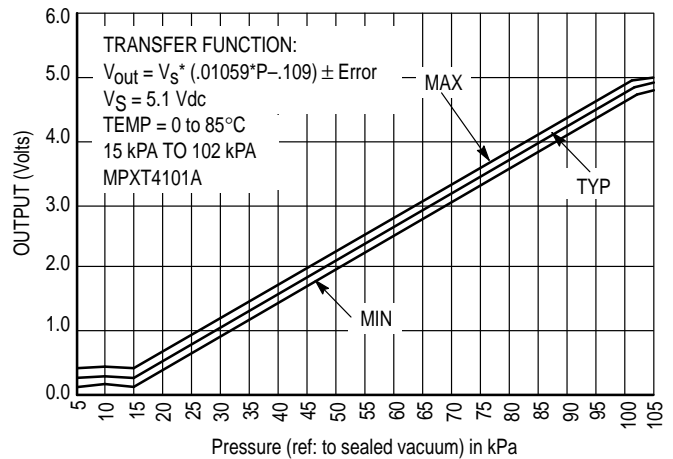

Figure 5. Output versus Absolute Pressure

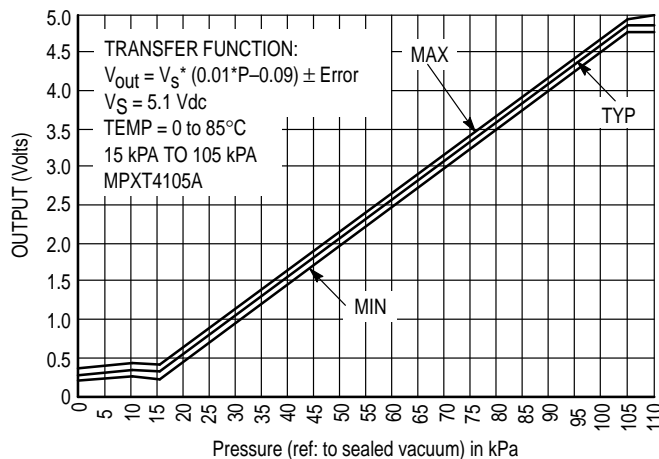

Figure 6. Output versus Absolute Pressure

Transfer Function (MPXT4100A)

Nominal Transfer Value: $V_{out} = V_S (P \times 0.01059 - 0.1518)$
 $\pm (\text{Pressure Error} \times \text{Temp. Factor} \times 0.01059 \times V_S)$
 $V_S = 5.1 \text{ V} \pm 0.25 \text{ Vdc}$

Temperature Error Band

MPXT4100A Series

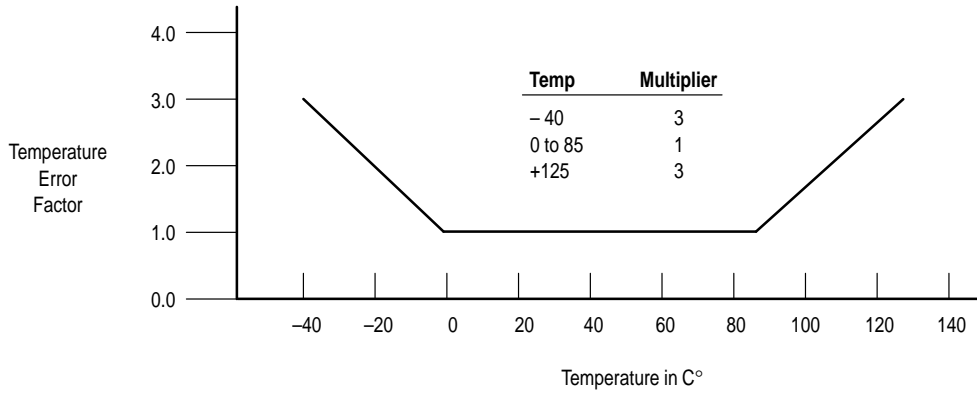

Pressure Error Band

Error Limits for Pressure

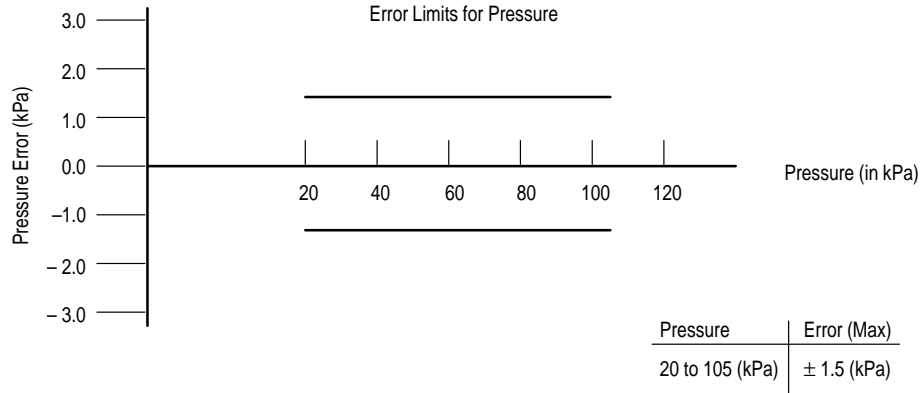

MPXT4100 MPXT4101 MPXT4105 SERIES

Transfer Function (MPXT4101A)

Nominal Transfer Value: $V_{out} = V_S (P \times 0.01059 - 0.10941)$
 $\pm (\text{Pressure Error} \times \text{Temp. Factor} \times 0.01059 \times V_S)$
 $V_S = 5.1 \text{ V} \pm 0.25 \text{ Vdc}$

Temperature Error Band

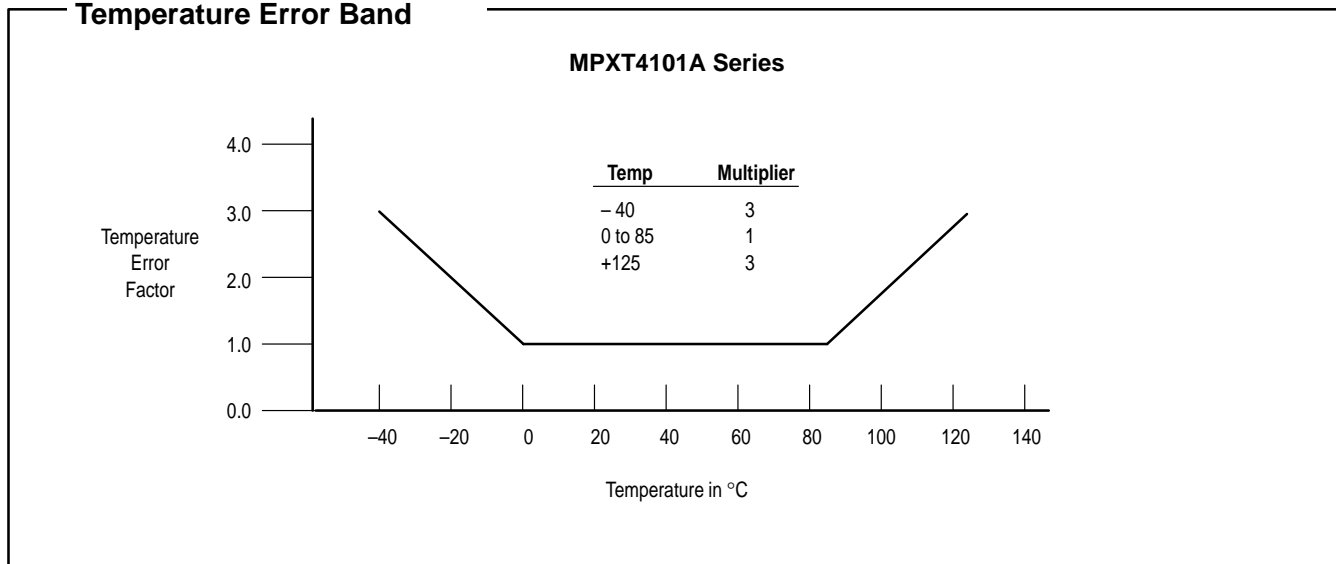

Pressure Error Band

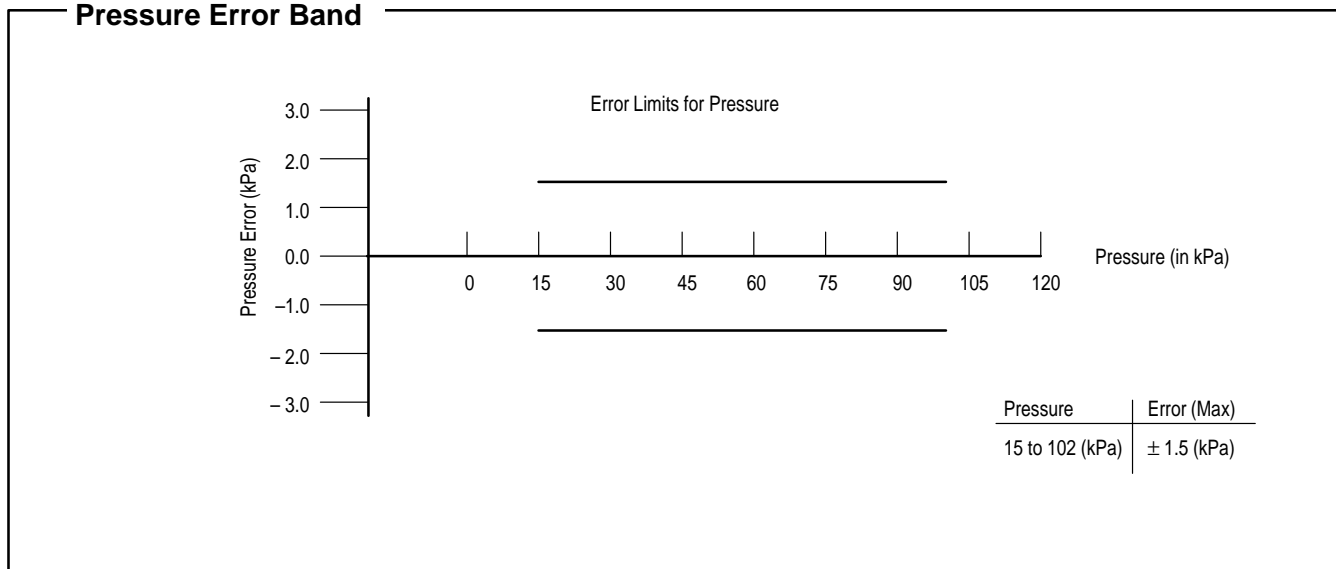

Transfer Function (MPXT4105A)

Nominal Transfer Value: $V_{out} = V_S (P \times 0.01 - 0.09)$
 $\pm (\text{Pressure Error} \times \text{Temp. Factor} \times 0.01 \times V_S)$
 $V_S = 5.1 \text{ V} \pm 0.25 \text{ Vdc}$

Temperature Error Band

MPXT4105A Series

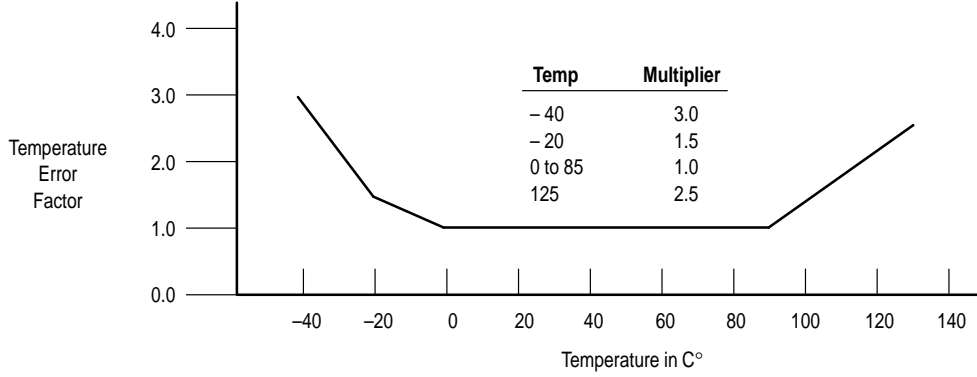

NOTE: The Temperature Multiplier is a linear response from -40°C to -20°C, -20°C to 0°C, and from 85°C to 125°C

Pressure Error Band

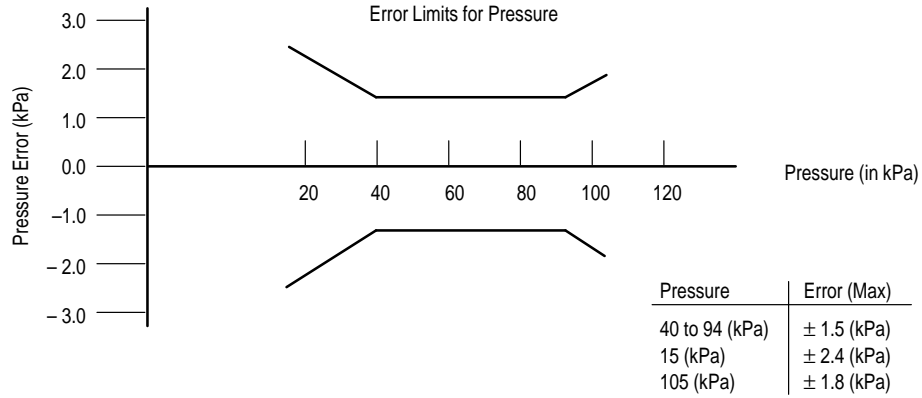

MPXT4100 MPXT4101 MPXT4105 SERIES

ORDERING INFORMATION

The MPXT4100A, MPXT4101A, AND MPXT4105A series MAP silicon pressure sensors are available to be shipped in rails.

| Packing Options | Port Options | Leadform | Case No. | MPXT Series Order No. | Marking |
|-----------------|--------------|-----------|----------|-----------------------|-----------|
| Rails | Element | 84 degree | 473A-01 | MPXT4100A7U | MPXT4100A |
| Rails | Element | 84 degree | 473A-01 | MPXT4101A7U | MPXT4101A |
| Rails | Element | 84 degree | 473A-01 | MPXT4105A7U | MPXT4105A |

PACKAGE DIMENSIONS

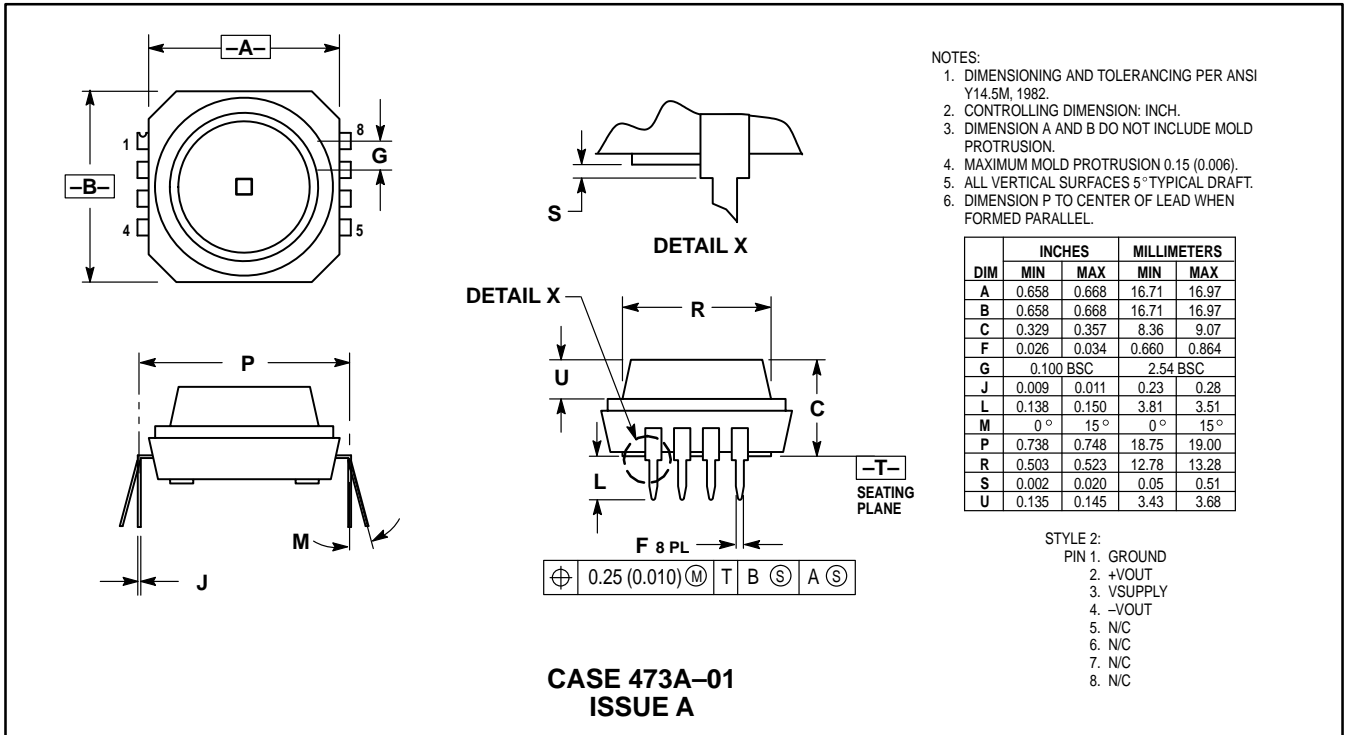

Motorola reserves the right to make changes without further notice to any products herein. Motorola makes no warranty, representation or guarantee regarding the suitability of its products for any particular purpose, nor does Motorola assume any liability arising out of the application or use of any product or circuit, and specifically disclaims any and all liability, including without limitation consequential or incidental damages. "Typical" parameters which may be provided in Motorola data sheets and/or specifications can and do vary in different applications and actual performance may vary over time. All operating parameters, including "Typicals" must be validated for each customer application by customer's technical experts. Motorola does not convey any license under its patent rights nor the rights of others. Motorola products are not designed, intended, or authorized for use as components in systems intended for surgical implant into the body, or other applications intended to support or sustain life, or for any other application in which the failure of the Motorola product could create a situation where personal injury or death may occur. Should Buyer purchase or use Motorola products for any such unintended or unauthorized application, Buyer shall indemnify and hold Motorola and its officers, employees, subsidiaries, affiliates, and distributors harmless against all claims, costs, damages, and expenses, and reasonable attorney fees arising out of, directly or indirectly, any claim of personal injury or death associated with such unintended or unauthorized use, even if such claim alleges that Motorola was negligent regarding the design or manufacture of the part. Motorola and are registered trademarks of Motorola, Inc. Motorola, Inc. is an Equal Opportunity/Affirmative Action Employer.

Mfax is a trademark of Motorola, Inc.

How to reach us:

USA/EUROPE/Locations Not Listed: Motorola Literature Distribution;
 P.O. Box 5405, Denver, Colorado 80217. 1-303-675-2140 or 1-800-441-2447

JAPAN: Nippon Motorola Ltd.: SPD, Strategic Planning Office, 4-32-1,
 Nishi-Gotanda, Shinagawa-ku, Tokyo 141, Japan. 81-3-5487-8488

Customer Focus Center: 1-800-521-6274

Mfax™: RMFAX0@email.sps.mot.com – TOUCHTONE 1-602-244-6609
 Motorola Fax Back System – US & Canada ONLY 1-800-774-1848
 – http://sps.motorola.com/mfax/

ASIA/PACIFIC: Motorola Semiconductors H.K. Ltd.; 8B Tai Ping Industrial Park,
 51 Ting Kok Road, Tai Po, N.T., Hong Kong. 852-26629298

HOME PAGE: <http://motorola.com/sps/>

