

Product Preview

64K x 16 Bit 3.3 V Asynchronous Fast Static RAM

The MCM6323A is a 1,048,576 bit static random access memory organized as 65,536 words of 16 bits. Static design eliminates the need for external clocks or timing strobes; CMOS circuitry reduces power consumption and provides for greater reliability.

The MCM6323A is equipped with chip enable (\bar{E}), write enable (\bar{W}), and output enable (\bar{G}) pins, allowing for greater system flexibility and eliminating bus contention problems. Separate byte enable controls ($\bar{L}B$ and $\bar{U}B$) allow individual bytes to be written and read. $\bar{L}B$ controls the 8 DQa bits, while $\bar{U}B$ controls the 8 DQb bits.

The MCM6323A is available in a 400 mil small-outline J-leaded (SOJ) package and a 44-lead TSOP Type II package in copper leadframe for optimum printed circuit board (PCB) reliability.

- Single 3.3 V \pm 0.3 V Power Supply
 - Fast Access Time: 10, 12, 15 ns
 - Equal Address and Chip Enable Access Time
 - All Inputs and Outputs are TTL Compatible
 - Data Byte Control
 - Fully Static Operation
 - Power Operation: 140/135/130 mA Maximum, Active AC
 - Industrial Temperature Option: - 40 to + 85°C
- Part Number: SCM6323AYJ10A

MCM6323A

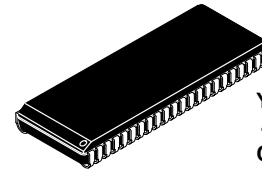

YJ PACKAGE
400 MIL SOJ
CASE 919-01



TS PACKAGE
44-LEAD
TSOP TYPE II
CASE 924A-01

PIN ASSIGNMENT

A	1	44	A
A	2	43	A
A	3	42	A
A	4	41	\bar{G}
A	5	40	$\bar{U}B$
\bar{E}	6	39	$\bar{L}B$
DQa	7	38	DQb
DQa	8	37	DQb
DQa	9	36	DQb
DQa	10	35	DQb
V _{DD}	11	34	V _{SS}
V _{SS}	12	33	V _{DD}
DQa	13	32	DQb
DQa	14	31	DQb
DQa	15	30	DQb
DQa	16	29	DQb
\bar{W}	17	28	NC
A	18	27	A
A	19	26	A
A	20	25	A
A	21	24	A
NC	22	23	NC

BLOCK DIAGRAM

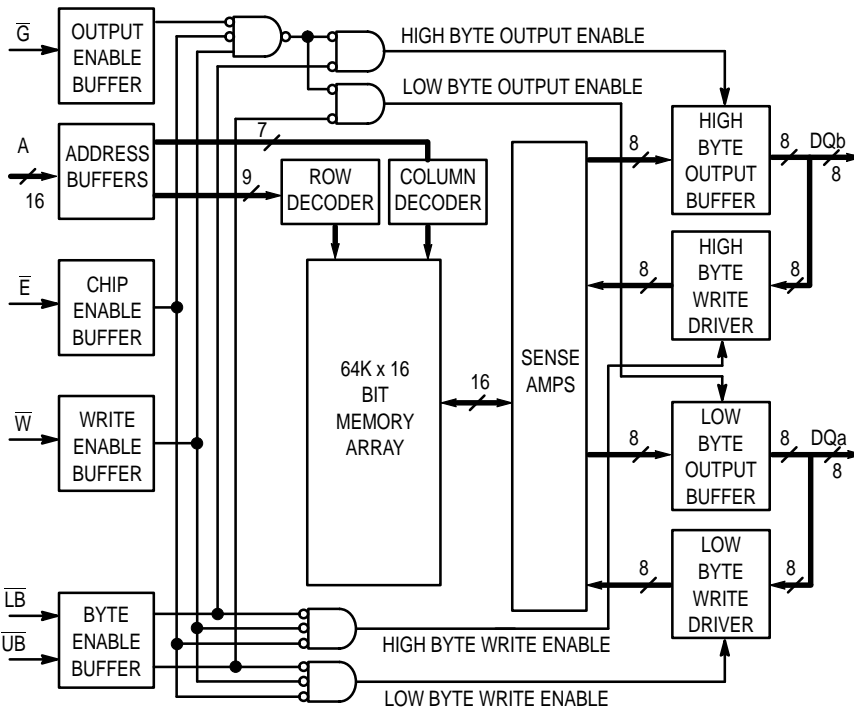

PIN NAMES

A	Address Input
\bar{E}	Chip Enable
\bar{W}	Write Enable
\bar{G}	Output Enable
$\bar{U}B$	Upper Byte
$\bar{L}B$	Lower Byte
DQa	Lower Data Input/Output
DQb	Upper Data Input/Output
V _{DD}	+ 3.3 V Power Supply
V _{SS}	Ground
NC	No Connection

This document contains information on a new product under development. Motorola reserves the right to change or discontinue this product without notice.

REV 1
10/17/97

TRUTH TABLE (X = Don't Care)

\bar{E}	\bar{G}	\bar{W}	\bar{LB}	\bar{UB}	Mode	VDD Current	DQa's	DQb's
H	X	X	X	X	Not Selected	I _{SB1} , I _{SB2}	High-Z	High-Z
L	H	H	X	X	Output Disabled	I _{DDA}	High-Z	High-Z
L	X	X	H	H	Output Disabled	I _{DDA}	High-Z	High-Z
L	L	H	L	H	Low Byte Read	I _{DDA}	D _{out}	High-Z
L	L	H	H	L	High Byte Read	I _{DDA}	High-Z	D _{out}
L	L	H	L	L	Word Read	I _{DDA}	D _{out}	D _{out}
L	X	L	L	H	Low Byte Write	I _{DDA}	D _{in}	High-Z
L	X	L	H	L	High Byte Write	I _{DDA}	High-Z	D _{in}
L	X	L	L	L	Word Write	I _{DDA}	D _{in}	D _{in}

ABSOLUTE MAXIMUM RATINGS (See Notes)

Rating	Symbol	Value	Unit
Supply Voltage	V _{DD}	- 0.5 to + 4.6	V
Voltage on Any Pin	V _{in}	- 0.5 to V _{DD} + 0.5	V
Output Current per Pin	I _{out}	± 20	mA
Package Power Dissipation	P _D	.75	W
Temperature Under Bias	T _{bias}	- 10 to + 85 - 45 to + 90	°C
Operating Temperature	T _A	0 to + 70 - 40 to + 85	°C
Storage Temperature	T _{stg}	- 55 to + 150	°C

NOTES:

1. Permanent device damage may occur if ABSOLUTE MAXIMUM RATINGS are exceeded. Functional operation should be restricted to RECOMMENDED OPERATING CONDITIONS. Exposure to higher than recommended voltages for extended periods of time could affect device reliability.
2. All voltages are referenced to V_{SS}.
3. Power dissipation capability will be dependent upon package characteristics and use environment.

This device contains circuitry to protect the inputs against damage due to high static voltages or electric fields; however, it is advised that normal precautions be taken to avoid application of any voltage higher than maximum rated voltages to these high-impedance circuits.

This CMOS memory circuit has been designed to meet the dc and ac specifications shown in the tables, after thermal equilibrium has been established. The circuit is in a test socket or mounted on a printed circuit board and transverse air flow of at least 500 linear feet per minute is maintained.

DC OPERATING CONDITIONS AND CHARACTERISTICS

($V_{DD} = 3.3 \text{ V} \pm 0.3 \text{ V}$, $T_A = 0 \text{ to } 70^\circ\text{C}$, Unless Otherwise Noted)

($T_A = -40 \text{ to } +85^\circ\text{C}$ for Industrial Temperature Offering)

RECOMMENDED OPERATING CONDITIONS

Parameter	Symbol	Min	Typ	Max	Unit
Power Supply Voltage	V_{DD}	3.0	3.3	3.6	V
Input High Voltage	V_{IH}	2.2	—	$V_{DD} + 0.3^{**}$	V
Input Low Voltage	V_{IL}	-0.5*	—	0.8	V

* $V_{IL}(\text{min}) = -0.5 \text{ V dc}$; $V_{IL}(\text{min}) = -2.0 \text{ V ac}$ (pulse width $\leq 20 \text{ ns}$) for $I \leq 20.0 \text{ mA}$.

** $V_{IH}(\text{max}) = V_{DD} + 0.3 \text{ V dc}$; $V_{IH}(\text{max}) = V_{DD} + 2.0 \text{ V ac}$ (pulse width $\leq 20 \text{ ns}$) for $I \leq 20.0 \text{ mA}$.

DC CHARACTERISTICS

Parameter	Symbol	Min	Max	Unit
Input Leakage Current (All Inputs, $V_{in} = 0 \text{ to } V_{DD}$)	$I_{lkg(I)}$	—	± 1.0	μA
Output Leakage Current ($\bar{E} = V_{IH}$, $V_{out} = 0 \text{ to } V_{DD}$)	$I_{lkg(O)}$	—	± 1.0	μA
Output Low Voltage ($I_{OL} = +4.0 \text{ mA}$) ($I_{OL} = +100 \mu\text{A}$)	V_{OL}	—	0.4 $V_{SS} + 0.2$	V
Output High Voltage ($I_{OH} = -4.0 \text{ mA}$) ($I_{OH} = -100 \mu\text{A}$)	V_{OH}	2.4 $V_{DD} - 0.2$	—	V

POWER SUPPLY CURRENTS (See Note 1)

Parameter	Symbol	6323A-10	6323A-12	6323A-15	Unit	Notes
AC Active Supply Current ($I_{out} = 0 \text{ mA}$) ($V_{DD} = \text{max}$, $f = f_{\text{max}}$)	I_{DDA}	140 150	135 140	130 135	mA	2
AC Standby Current ($\bar{E} = V_{IH}$, $V_{DD} = \text{max}$, $f = f_{\text{max}}$)	I_{SB1}	40 45	35 40	30 35	mA	2
CMOS Standby Current ($V_{DD} = \text{max}$, $f = 0 \text{ MHz}$, $\bar{E} \geq V_{DD} - 0.2 \text{ V}$, $V_{in} \leq V_{SS} + 0.2 \text{ V}$, or $\geq V_{DD} - 0.2 \text{ V}$)	I_{SB2}	5 5	5 5	5 5	mA	

NOTES:

1. Typical current = 25°C @ 3.3 V.
2. Reference AC Operating Conditions and Characteristics for input and timing (V_{IH}/V_{IL} , t_r/t_f , pulse level 0 to 3.0 V, $V_{IH} = 3.0 \text{ V}$, $V_{IL} = 0 \text{ V}$).

CAPACITANCE ($f = 1.0 \text{ MHz}$, $dV = 3.0 \text{ V}$, $T_A = 25^\circ\text{C}$, Periodically Sampled Rather Than 100% Tested)

Parameter	Symbol	Typ	Max	Unit
Address Input Capacitance	C_{in}	—	6	pF
Control Input Capacitance	C_{in}	—	6	pF
Input/Output Capacitance	$C_{I/O}$	—	8	pF

AC OPERATING CONDITIONS AND CHARACTERISTICS

($V_{DD} = 3.3\text{ V} \pm 0.3\text{ V}$, $T_A = 0\text{ to }+70^\circ\text{C}$, Unless Otherwise Noted)

($T_A = -40\text{ to }+85^\circ\text{C}$ for Industrial Temperature Offering)

Logic Input Timing Measurement Reference Level 1.50 V
 Logic Input Pulse Levels 0 to 3.0 V
 Input Rise/Fall Time 2 ns

Output Timing Reference Level 1.50 V
 Output Load See Figure 1

READ CYCLE TIMING (See Notes 1, 2, 3, and 4)

Parameter	Symbol	MCM6323A-10		MCM6323A-12		MCM6323A-15		Unit	Notes
		Min	Max	Min	Max	Min	Max		
Read Cycle Time	t_{AVAV}	10	—	12	—	15	—	ns	5
Address Access Time	t_{AVQV}	—	10	—	12	—	15	ns	
Enable Access Time	t_{ELQV}	—	10	—	12	—	15	ns	
Output Enable Access Time	t_{GLQV}	—	4	—	5	—	6	ns	6
Output Hold from Address Change	t_{AXQX}	3	—	3	—	3	—	ns	
Enable Low to Output Active	t_{ELQX}	3	—	3	—	3	—	ns	6, 7, 8
Output Enable Low to Output Active	t_{GLQX}	0	—	0	—	0	—	ns	6, 7, 8
Enable High to Output High-Z	t_{EHQZ}	—	4	—	5	—	6	ns	6, 7, 8
Output Enable High to Output High-Z	t_{GHQZ}	—	4	—	5	—	6	ns	6, 7, 8
Byte Enable Access Time	t_{BLQV}	—	4	—	5	—	6	ns	
Byte Enable Low to Output Active	t_{BLQX}	0	—	0	—	0	—	ns	6, 7, 8
Byte High to Output High-Z	t_{BHQZ}	0	5	0	5	0	5	ns	6, 7, 8

NOTES:

1. \bar{W} is high for read cycle.
2. For common I/O applications, minimization, or elimination of bus contention conditions is necessary during read and write cycles.
3. Device is continuously selected ($\bar{E} = V_{IL}$, $\bar{G} = V_{IL}$, and $\bar{L}\bar{B}$ and/or $\bar{U}\bar{B} = V_{IL}$).
4. Addresses valid prior to or coincident with \bar{E} going low.
5. All read cycle timings are referenced from the last valid address to the first transitioning address.
6. Transition is measured 200 mV from steady-state voltage.
7. At any given voltage and temperature, t_{EHQZ} (max) < t_{ELQX} (min), and t_{GHQZ} (max) < t_{GLQX} (min), both for a given device and from device to device.
8. This parameter is sampled and not 100% tested.

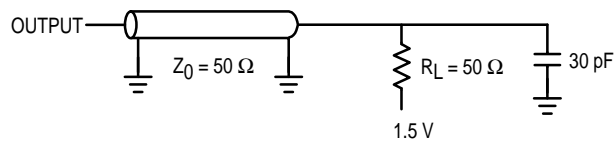

Figure 1. Equivalent AC Test Load

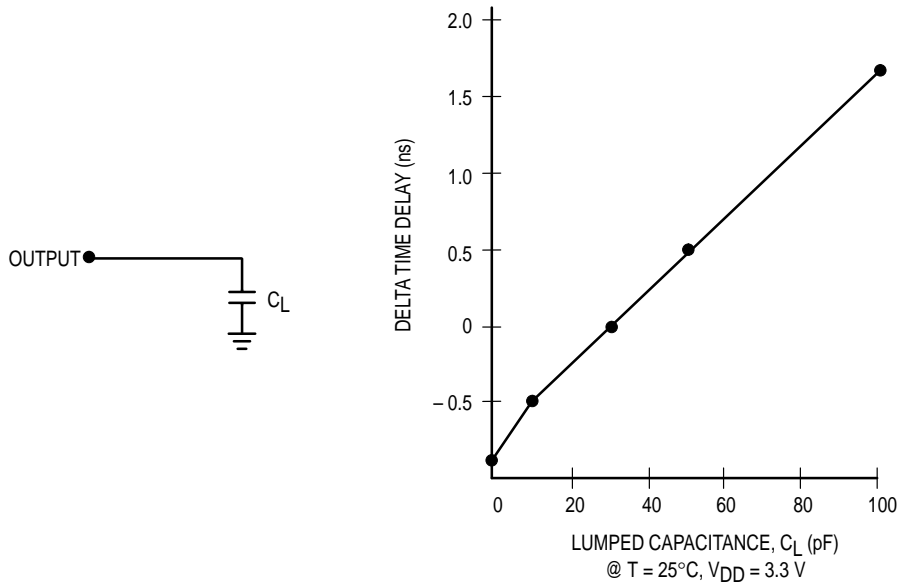

Figure 2. Lumped Capacitive Load and Typical Derating Curve

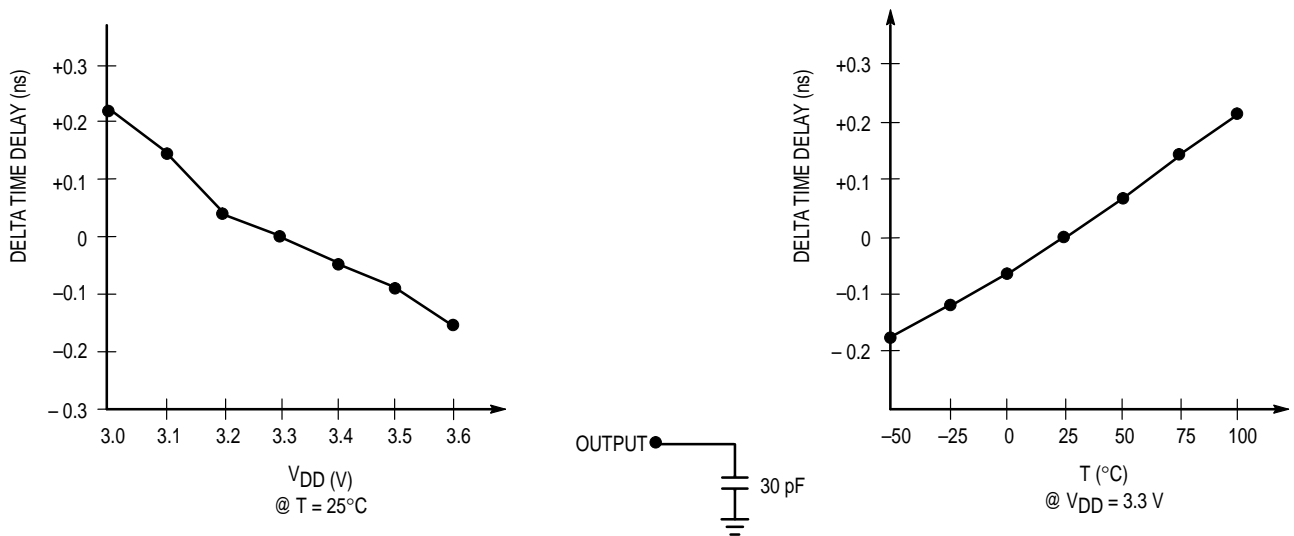
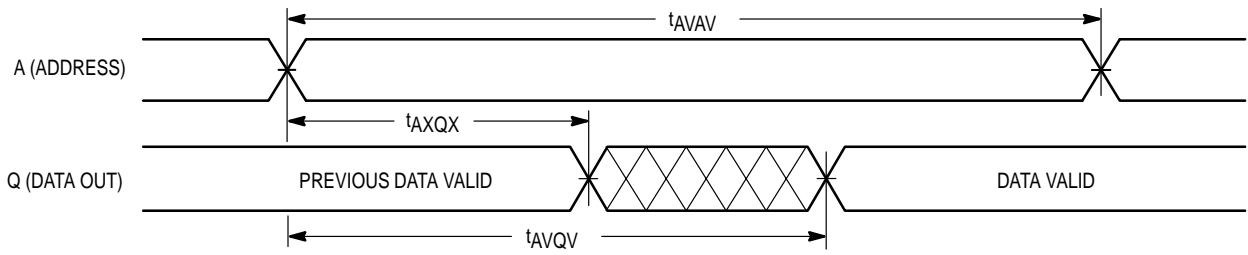
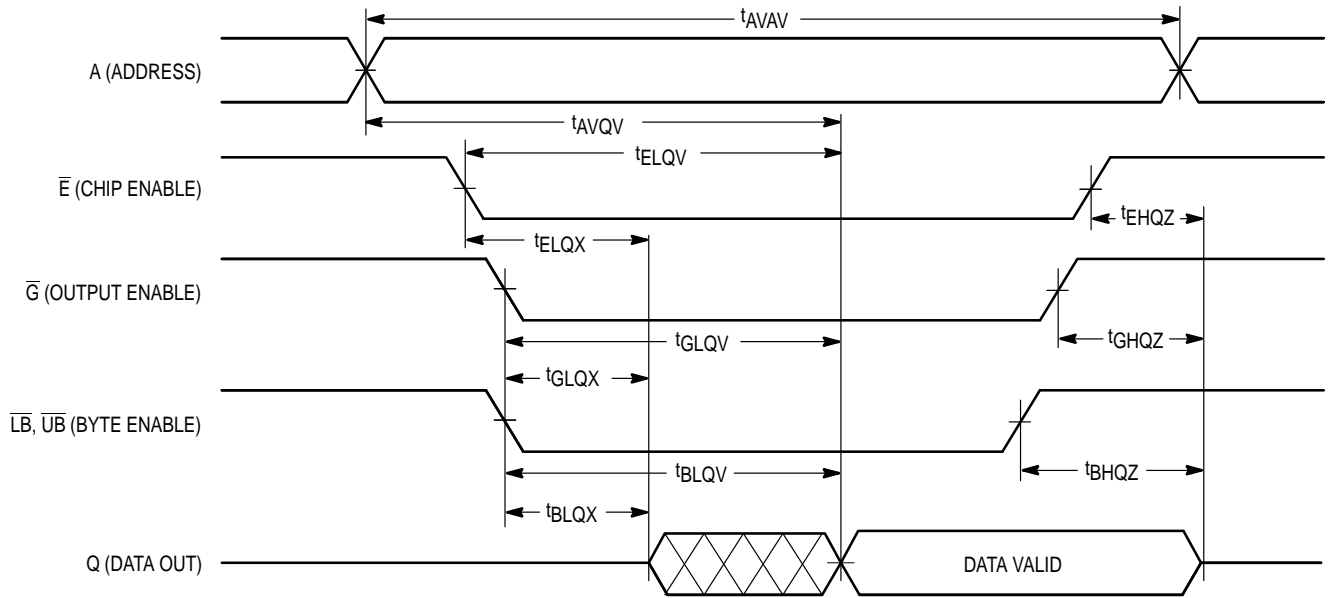

Figure 3. Derating Across Temperature and Voltage

READ CYCLE 1 (See Note 7)



READ CYCLE 2 (See Note 8)



WRITE CYCLE 1 (\overline{W} Controlled, See Notes 1 and 2)

Parameter	Symbol	MCM6323A-10		MCM6323A-12		MCM6323A-15		Unit	Notes
		Min	Max	Min	Max	Min	Max		
Write Cycle Time	t_{AVAV}	10	—	12	—	15	—	ns	3
Address Setup Time	t_{AVWL}	0	—	0	—	0	—	ns	
Address Valid to End of Write	t_{AVWH}	8	—	9	—	10	—	ns	
Write Pulse Width	t_{WLWH} , t_{WLEH}	8	—	9	—	10	—	ns	
Byte Pulse Width	t_{BLWH} , t_{BLEH}	8	—	9	—	10	—	ns	
Data Valid to End of Write	t_{DVWH}	4	—	5	—	6	—	ns	
Data Hold Time	t_{WHDX}	0	—	0	—	0	—	ns	
Write Low to Data High-Z	t_{WLQZ}	0	4	0	5	0	6	ns	4, 5, 6
Write High to Output Active	t_{WHQX}	3	—	3	—	3	—	ns	4, 5, 6
Write Recovery Time	t_{WHAX}	0	—	0	—	0	—	ns	

NOTES:

1. A write occurs during the overlap of \overline{E} low, \overline{W} low, and \overline{LB} and/or \overline{UB} low.
2. For common I/O applications, minimization or elimination of bus contention conditions is necessary during read and write cycles.
3. All write cycle timings are referenced from the last valid address to the first transitioning address.
4. Transition is measured 200 mV from steady-state voltage.
5. At any given voltage and temperature, $t_{WLQZ} \max < t_{WHQX} \min$ both for a given device and from device to device.
6. This parameter is sampled and not 100% tested.

WRITE CYCLE 1
(\overline{W} Controlled)

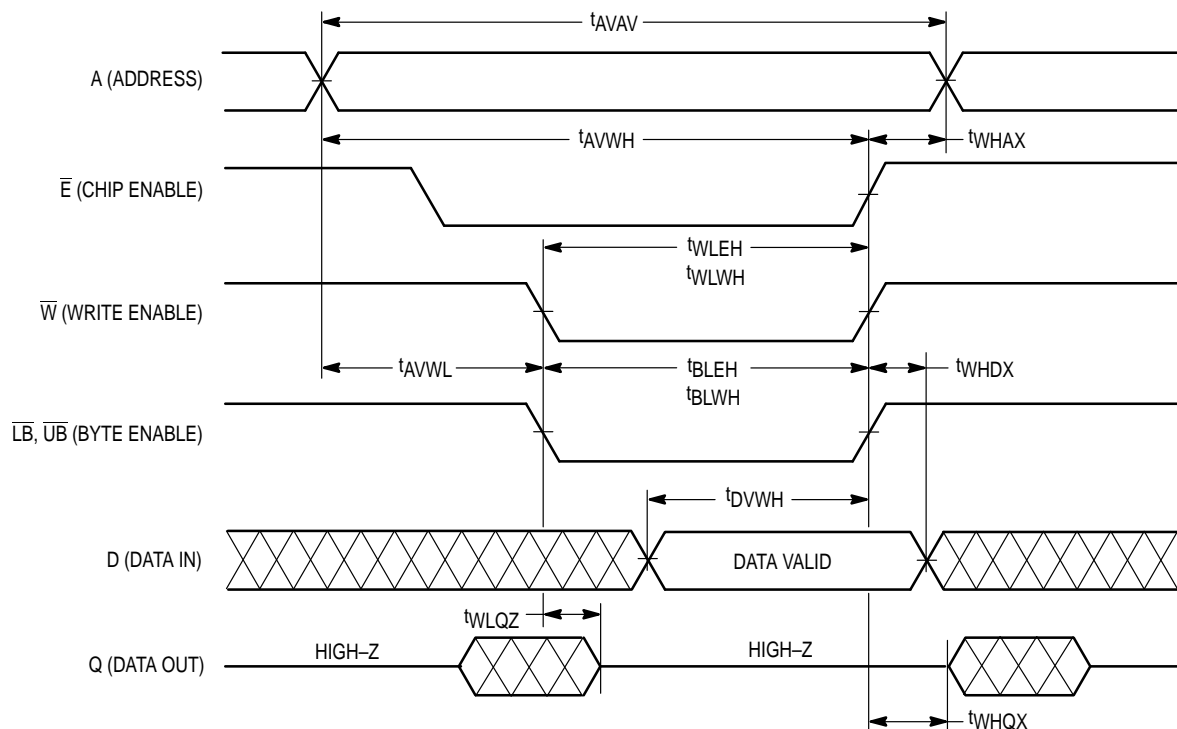

WRITE CYCLE 2 (\bar{E} Controlled, See Notes 1 and 2)

Parameter	Symbol	MCM6323A-10		MCM6323A-12		MCM6323A-15		Unit	Notes
		Min	Max	Min	Max	Min	Max		
Write Cycle Time	t_{AVAV}	10	—	12	—	15	—	ns	3
Address Setup Time	t_{AVEL}	0	—	0	—	0	—	ns	
Address Valid to End of Write	t_{AVEH}	8	—	9	—	10	—	ns	
Enable to End of Write	t_{ELEH} , t_{ELWH}	8	—	9	—	10	—	ns	4, 5
Data Valid to End of Write	t_{DVEH}	4	—	5	—	6	—	ns	
Data Hold Time	t_{EHDX}	0	—	0	—	0	—	ns	
Write Recovery Time	t_{EHAX}	0	—	0	—	0	—	ns	

NOTES:

1. A write occurs during the overlap of \bar{E} low, \bar{W} low, and $\bar{L}\bar{B}$ and/or $\bar{U}\bar{B}$ low.
2. For common I/O applications, minimization or elimination of bus contention conditions is necessary during read and write cycles.
3. All write cycle timings are referenced from the last valid address to the first transitioning address.
4. If \bar{E} goes low coincident with or after \bar{W} goes low, the output will remain in a high impedance condition.
5. If \bar{E} goes high coincident with or before \bar{W} goes high, the output will remain in a high impedance condition.

WRITE CYCLE 2
(\bar{E} Controlled)

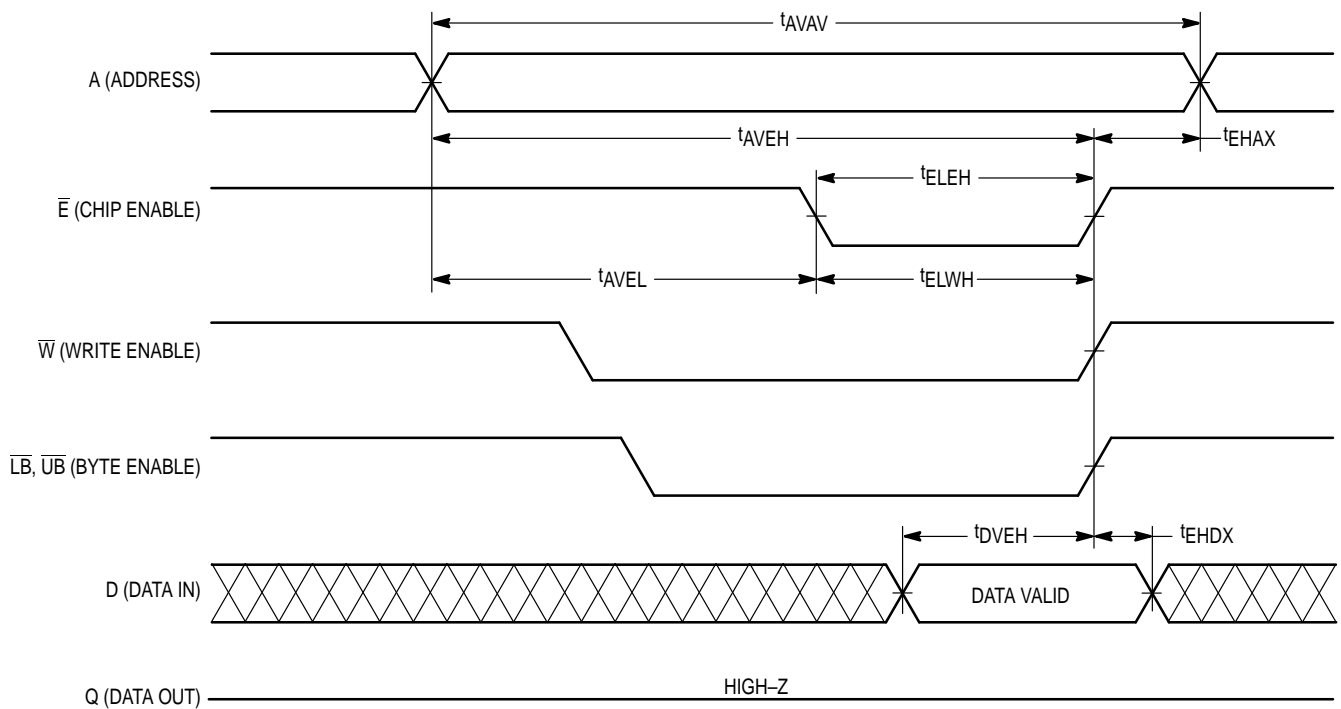

WRITE CYCLE 3 (\bar{B} Controlled, See Notes 1 and 2)

Parameter	Symbol	MCM6323A-10		MCM6323A-12		MCM6323A-15		Unit	Notes
		Min	Max	Min	Max	Min	Max		
Write Cycle Time	t_{AVAV}	10	—	12	—	15	—	ns	3
Address Setup Time	t_{AVBL}	0	—	0	—	0	—	ns	
Address Valid to End of Write	t_{AVBH}	8	—	9	—	10	—	ns	
Write Pulse Width	t_{WLWH} , t_{WLEH}	8	—	9	—	10	—	ns	
Byte Pulse Width	t_{BLWH} , t_{BLEH} , t_{BLBH}	8	—	9	—	10	—	ns	
Data Valid to End of Write	t_{DVBH}	5	—	6	—	7	—	ns	
Data Hold Time	t_{BHDX}	0	—	0	—	0	—	ns	
Write Low to Data High-Z	t_{WLQZ}	0	4	0	5	0	6	ns	4, 5, 6
Write High to Output Active	t_{WHQX}	3	—	3	—	3	—	ns	4, 5, 6
Write Recovery Time	t_{BHAX}	0	—	0	—	0	—	ns	

NOTES:

1. A write occurs during the overlap of \bar{E} low, \bar{W} low, and $\bar{L}\bar{B}$ and/or $\bar{U}\bar{B}$ low.
2. For common I/O applications, minimization or elimination of bus contention conditions is necessary during read and write cycles.
3. All write cycle timings are referenced from the last valid address to the first transitioning address.
4. Transition is measured 200 mV from steady-state voltage.
5. At any given voltage and temperature, $t_{WLQZ} \text{ max} < t_{WHQX} \text{ min}$ both for a given device and from device to device.
6. This parameter is sampled and not 100% tested.

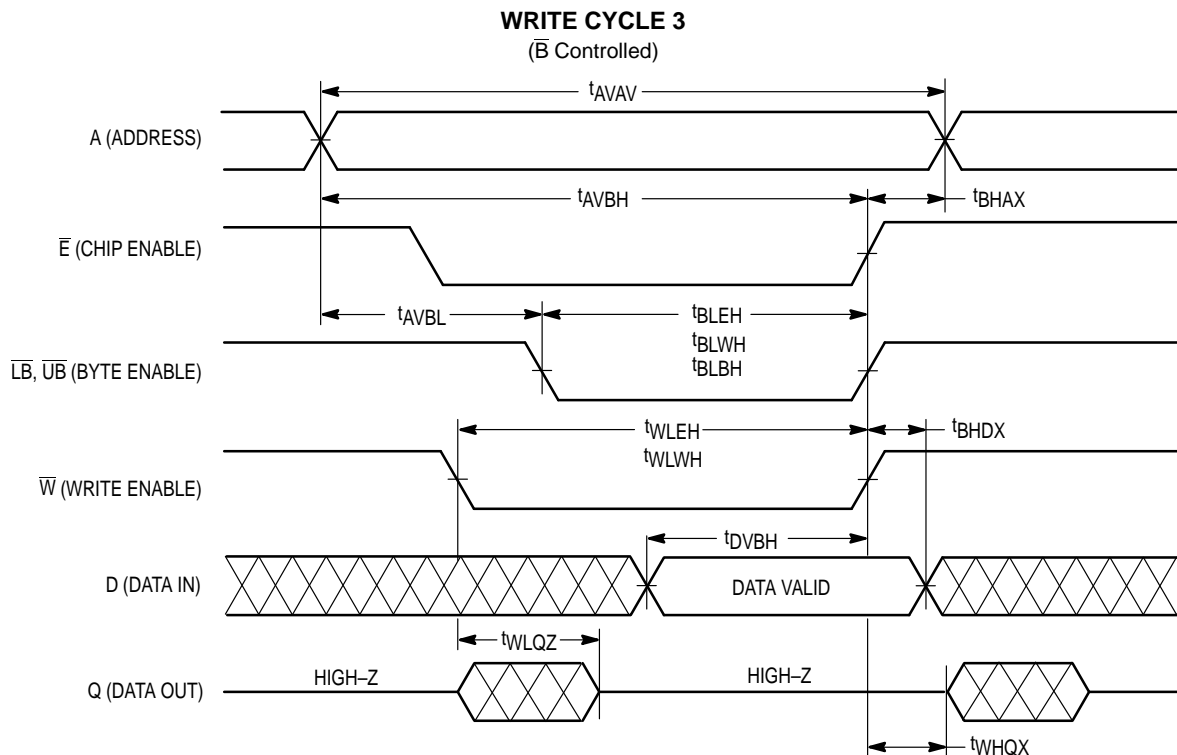

ORDERING INFORMATION
(Order by Full Part Number)

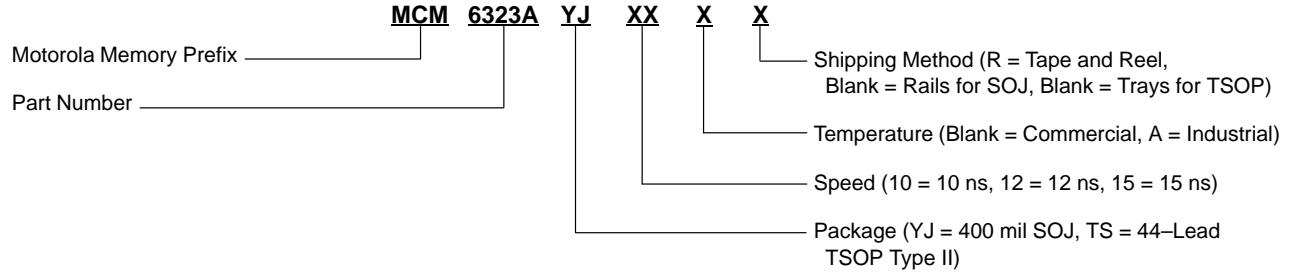

Full Commercial Part Numbers —	MCM6323AYJ10	MCM6323AYJ12	MCM6323AYJ15
	MCM6323AYJ10R	MCM6323AYJ12R	MCM6323AYJ15R
	MCM6323ATS10	MCM6323ATS12	MCM6323ATS15
	MCM6323ATS10R	MCM6323ATS12R	MCM6323ATS15R
Full Industrial Part Numbers —	SCM6323AYJ10A	SCM6323AYJ12A	SCM6323AYJ15A
	SCM6323AYJ10AR	SCM6323AYJ12AR	SCM6323AYJ15AR
	SCM6323ATS10A	SCM6323ATS12A	SCM6323ATS15A
	SCM6323ATS10AR	SCM6323ATS12AR	SCM6323ATS15AR

PACKAGE DIMENSIONS

YJ PACKAGE
400 MIL SOJ
CASE 919-01

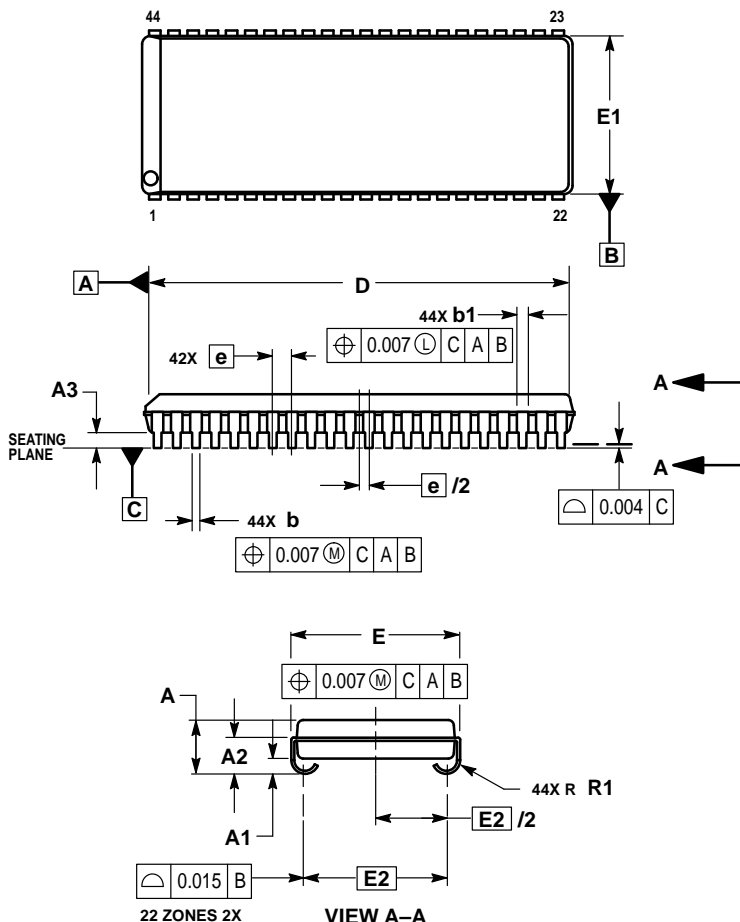

- NOTES:
1. DIMENSIONING AND TOLERANCING PER ASME Y14.5M, 1994.
 2. CONTROLLING DIMENSION: INCH.
 3. DIMENSION D DOES NOT INCLUDE MOLD FLASH, TIE BAR BURRS AND GATE BURRS. MOLD FLASH, TIE BAR BURRS AND GATE BURRS SHALL NOT EXCEED 0.006 PER END. DIMENSION E1 DOES NOT INCLUDE INTERLEAD FLASH. INTERLEAD FLASH SHALL NOT EXCEED 0.010 PER SIDE.
 4. THE PACKAGE TOP MAY BE SMALLER THAN THE PACKAGE BOTTOM. DIMENSIONS D AND E1 AND, HENCE, DATUMS A AND B, ARE DETERMINED AT THE OUTERMOST EXTREMES OF THE PLASTIC BODY EXCLUSIVE OF MOLD FLASH, TIE BAR BURRS, GATE BURRS AND INTERLEAD FLASH, BUT INCLUDING ANY MISMATCH BETWEEN THE TOP AND BOTTOM OF THE PLASTIC BODY.
 5. DIMENSION b1 DOES NOT INCLUDE DAMBAR PROTRUSION OR INTRUSION. THE DAMBAR PROTRUSION(S) SHALL NOT CAUSE THE SHOULDER WIDTH TO EXCEED b1 MAX BY MORE THAN 0.005. THE DAMBAR INTRUSION(S) SHALL NOT REDUCE THE SHOULDER WIDTH TO LESS THAN 0.001 BELOW b1 MIN.

INCHES		
DIM	MIN	MAX
A	0.128	0.148
A1	0.025	—
A2	0.082	—
A3	0.035	0.045
b	0.015	0.020
b1	0.026	0.032
D	1.120	1.130
E	0.435	0.445
E1	0.395	0.405
E2	0.370 BSC	
e	0.050 BSC	
R1	0.030	0.040

**TS PACKAGE
44-LEAD
TSOP TYPE II
CASE 924A-01**

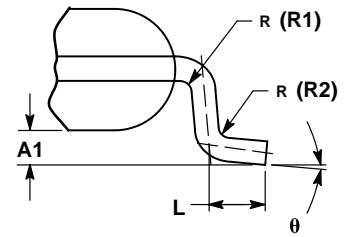
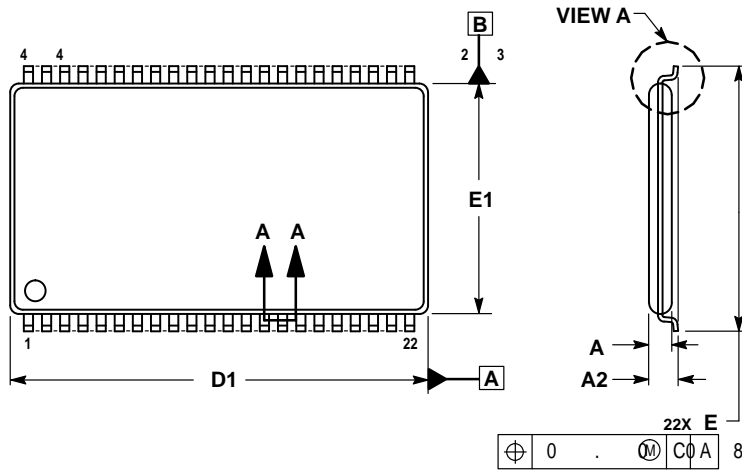

**DETAIL A
ROTATED 90° CLOCKWISE**

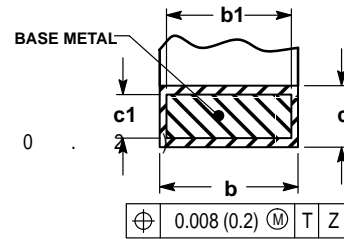

**SECTION A-A
40 PLACES**

NOTES:

1. DIMENSIONING AND TOLERANCING PER ANSI Y14.5M, 1982.
2. CONTROLLING DIMENSION: INCH.
3. DIMENSION D1 AND E1 DO NOT INCLUDE MOLD PROTRUSION. ALLOWABLE MOLD PROTRUSION IS 0.006 (0.015) PER SIDE.
4. DIMENSION b DOES NOT INCLUDE DAMBAR PROTRUSIONS. DAMBAR PROTRUSIONS SHALL NOT ALLOW THE b DIMENSION TO EXCEED 0.023 (0.58).

DIM	INCHES		MILLIMETERS	
	MIN	MAX	MIN	MAX
A	—	0.050	—	1.270
A1	0.002	0.006	0.051	0.152
A2	0.038	0.042	0.965	1.067
b	0.012	0.018	0.305	0.457
b1	0.012	0.016	0.305	0.406
c	0.005	0.008	0.127	0.203
c1	0.004	0.006	0.101	0.152
D1	0.721	0.729	18.313	18.517
e	0.0315 BSC		0.800 BSC	
E	0.456	0.470	11.582	11.938
E1	0.396	0.404	10.058	10.262
L	0.016	0.023	0.406	0.584
R1	0.004 REF		0.100 REF	
R2	0.004 REF		0.100 REF	
theta	0°	5°	0°	5°

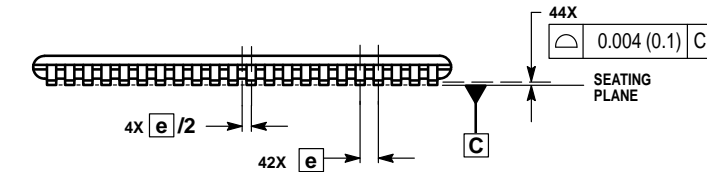

Motorola reserves the right to make changes without further notice to any products herein. Motorola makes no warranty, representation or guarantee regarding the suitability of its products for any particular purpose, nor does Motorola assume any liability arising out of the application or use of any product or circuit, and specifically disclaims any and all liability, including without limitation consequential or incidental damages. "Typical" parameters which may be provided in Motorola data sheets and/or specifications can and do vary in different applications and actual performance may vary over time. All operating parameters, including "Typicals" must be validated for each customer application by customer's technical experts. Motorola does not convey any license under its patent rights nor the rights of others. Motorola products are not designed, intended, or authorized for use as components in systems intended for surgical implant into the body, or other applications intended to support or sustain life, or for any other application in which the failure of the Motorola product could create a situation where personal injury or death may occur. Should Buyer purchase or use Motorola products for any such unintended or unauthorized application, Buyer shall indemnify and hold Motorola and its officers, employees, subsidiaries, affiliates, and distributors harmless against all claims, costs, damages, and expenses, and reasonable attorney fees arising out of, directly or indirectly, any claim of personal injury or death associated with such unintended or unauthorized use, even if such claim alleges that Motorola was negligent regarding the design or manufacture of the part. Motorola and are registered trademarks of Motorola, Inc. Motorola, Inc. is an Equal Opportunity/Affirmative Action Employer.

Mfax is a trademark of Motorola, Inc.

How to reach us:

USA/EUROPE/Locations Not Listed: Motorola Literature Distribution; P.O. Box 5405, Denver, Colorado, 80217. 1-303-675-2140 or 1-800-441-2447

Mfax™: RMFAX0@email.sps.mot.com – TOUCHTONE 1-602-244-6609
Motorola Fax Back System – US & Canada ONLY 1-800-774-1848
– http://sps.motorola.com/mfax/

HOME PAGE: http://motorola.com/sps/

JAPAN: Nippon Motorola Ltd.; SPD, Strategic Planning Office; 4-32-1, Nishi-Gotanda; Shinagawa-ku, Tokyo 141, Japan. 81-3-5487-8488

ASIA/PACIFIC: Motorola Semiconductors H.K. Ltd.; 8B Tai Ping Industrial Park, 51 Ting Kok Road, Tai Po, N.T., Hong Kong. 852-26629298

CUSTOMER FOCUS CENTER: 1-800-521-6274

