

## Optocoupler, Photodarlington Output, High Gain

### Features

- High collector-emitter breakdown voltage, 80 V minimum
- High isolation resistance,  $10^{11} \Omega$  typical
- Standard plastic DIP Package
- No base terminal connection for improved common mode interface immunity
- Lead-free component
- Component in accordance to RoHS 2002/95/EC and WEEE 2002/96/EC

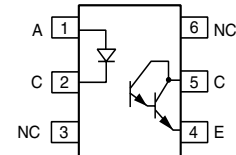
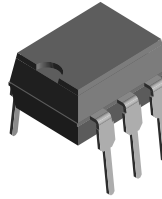

1179013



### Agency Approvals

- UL1577, File No. E52744 System Code H or J, Double Protection
- DIN EN 60747-5-2 (VDE0884)  
DIN EN 60747-5-5 pending  
Available with Option 1

used to replace reed and mercury relays with advantages of long life, high speed switching and elimination of magnetic fields.

### Description

The IL5xB and MOC8021 are optically coupled isolators with a gallium arsenide infrared LED and a silicon photodarlington sensor. Switching can be achieved while maintaining a high degree of isolation between driving and load circuits. These optocouplers can be

### Order Information

Part	Remarks
IL55B	CTR > 500 %, DIP-6
IL56B	CTR > 1000 %, DIP-6
MOC8021	CTR > 1000 %, DIP-6
IL55B-X006	CTR > 500 %, SMD-6 (option 7)
IL55B-X009	CTR > 500 %, SMD-6 (option 9)
IL55B-X007	CTR > 500 %, SMD-6 (option 7)

For additional information on the available options refer to Option Information.

### Absolute Maximum Ratings

$T_{amb} = 25^\circ\text{C}$ , unless otherwise specified

Stresses in excess of the absolute Maximum Ratings can cause permanent damage to the device. Functional operation of the device is not implied at these or any other conditions in excess of those given in the operational sections of this document. Exposure to absolute Maximum Rating for extended periods of the time can adversely affect reliability.

### Input

Parameter	Test condition	Symbol	Value	Unit
Peak reverse voltage		$V_R$	3.0	V
Forward continuous current		$I_F$	60	mA
Power dissipation		$P_{diss}$	100	mW
Derate linearly from $55^\circ\text{C}$			1.33	mW/ $^\circ\text{C}$

### Output

Parameter	Test condition	Symbol	Value	Unit
Collector-emitter breakdown voltage		$BV_{CEO}$	80	V
Emitter-collector breakdown voltage		$BV_{ECO}$	5.0	V
Collector (load) current		$I_C$	125	mA
Power dissipation		$P_{diss}$	150	mW
Derate linearly from 25 °C			2.0	mW/°C

### Coupler

Parameter	Test condition	Symbol	Value	Unit
Total power dissipation		$P_{tot}$	250	mW
Derate linearly from 25 °C			3.3	mW/°C
Isolation test voltage (between emitter and detector referred to standard climate 23 °C/50 % RH, DIN 50014)		$V_{ISO}$	5300	$V_{RMS}$
Creepage			≥ 7	mm
Clearance			≥ 7	mm
Tracking resistance, group III (KC > 600 per VDE 110 § 6, table 3 and DIN 54380/VDE 0330, part 1)				
Isolation resistance	$V_{IO} = 500 \text{ V}, T_{amb} = 25 \text{ °C}$	$R_{IO}$	$10^{12}$	$\Omega$
	$V_{IO} = 500 \text{ V}, T_{amb} = 100 \text{ °C}$	$R_{IO}$	$10^{11}$	$\Omega$
Storage temperature		$T_{stg}$	- 55 to + 150	°C
Operating temperature		$T_{amb}$	- 55 to + 100	°C
Lead soldering time at 260 °C		$T_{sld}$	10	sec.

### Electrical Characteristics

$T_{amb} = 25 \text{ °C}$ , unless otherwise specified

Minimum and maximum values are testing requirements. Typical values are characteristics of the device and are the result of engineering evaluation. Typical values are for information only and are not part of the testing requirements.

### Input

Parameter	Test condition	Symbol	Min	Typ.	Max	Unit
Forward voltage	$I_F = 50 \text{ mA}$	$V_F$		1.25	1.5	V
Reverse current	$V_R = 3.0 \text{ V}$	$I_R$		0.1	10	$\mu\text{A}$
Capacitance	$V_R = 0 \text{ V}$	$C_O$		25		pF

### Output

Parameter	Test condition	Symbol	Min	Typ.	Max	Unit
Collector-emitter breakdown voltage	$I_C = 1.0 \text{ mA}, I_F = 0$	$BV_{CEO}$	80			V
Emitter-collector breakdown voltage	$I_E = 100 \text{ }\mu\text{A}, I_F = 0$	$BV_{ECO}$	5.0	10		V
Collector-emitter leakage current	$V_{CE} = 60 \text{ V}$	$I_{CEO}$			1.0	$\mu\text{A}$

## Coupler

Parameter	Test condition	Symbol	Min	Typ.	Max	Unit
Coupling capacitance		$C_C$		1.5		pF
Collector-emitter saturation voltage	$I_C = 2.0 \text{ mA}, I_F = 1.0 \text{ mA}$	$V_{CE(sat)}$			1.0	V

## Current Transfer Ratio

Parameter	Test condition	Part	Symbol	Min	Typ.	Max	Unit
Current Transfer Ratio	$I_F = 10 \text{ mA}, I_C = 0$	IL55B	CTR	500			%
		IL56B	CTR	1000			%
		MOC8021	CTR	1000			%

## Switching Characteristics

Parameter	Test condition	Symbol	Min	Typ.	Max	Unit
Turn-on time	$V_{CC} = 10 \text{ V}$	$t_{ON}$		5.0		$\mu\text{s}$
Turn-off time	$I_F = 5.0 \text{ mA}, R_L = 100 \Omega$	$t_{OFF}$		100		$\mu\text{s}$

## Typical Characteristics ( $T_{amb} = 25^\circ\text{C}$ unless otherwise specified)

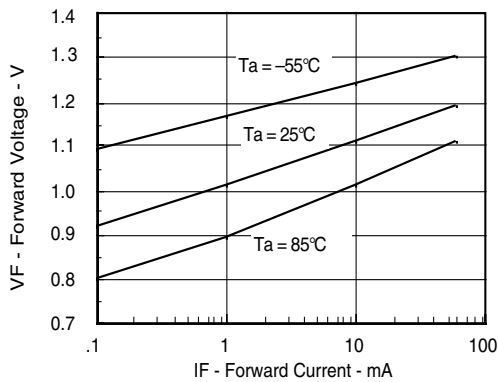

il55b\_01

Figure 1. Forward Voltage vs. Forward Current

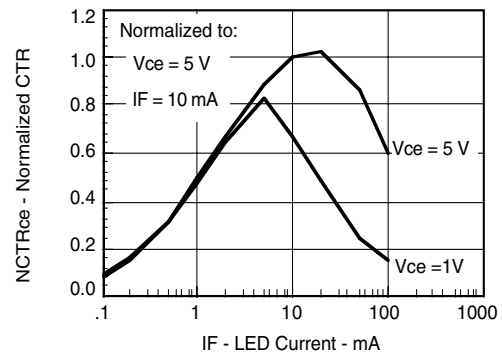

il55b\_02

Figure 2. Normalized Non-Saturated and Saturated  $CTR_{CE}$  vs. LED Current

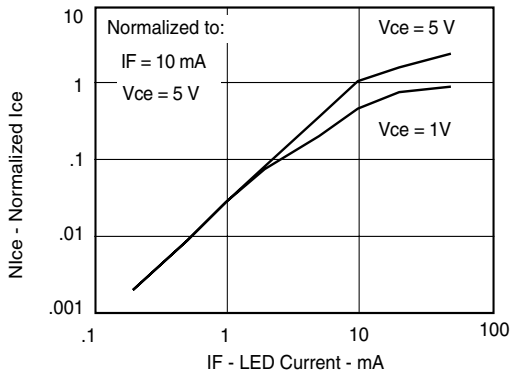

#55b\_03

Figure 3. Normalized Non-Saturated and Saturated Collector-Emitter Current vs. LED Current

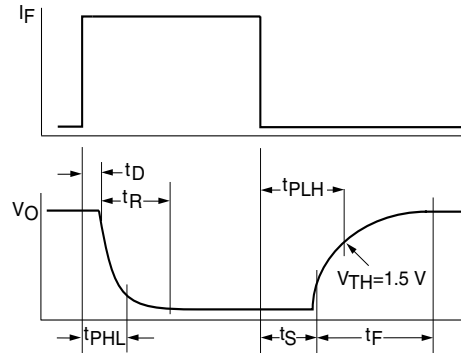

#55b\_06

Figure 6. Switching Waveform

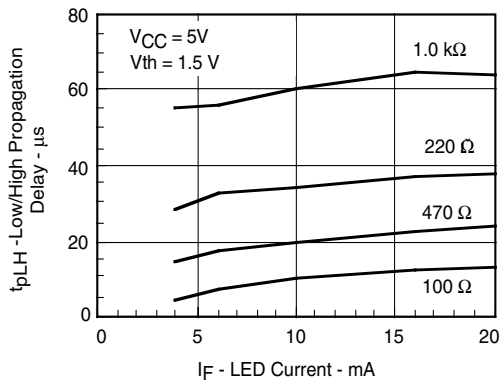

#55b\_04

Figure 4. Low to High Propagation Delay vs. Collector Load Resistance and LED Current

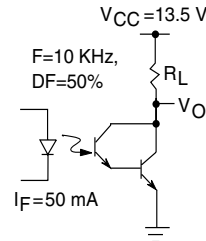

#55b\_07

Figure 7. Switching Schematic

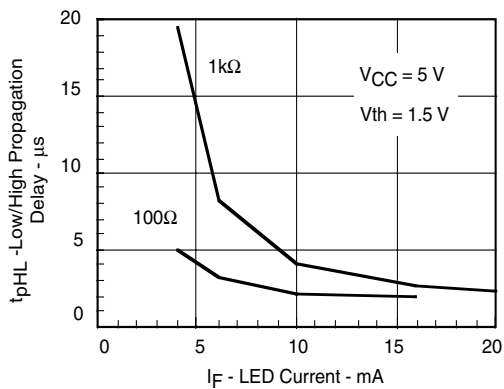

#55b\_05

Figure 5. High to low Propagation Delay vs. Collector Load Resistance and LED Current

## Package Dimensions in Inches (mm)

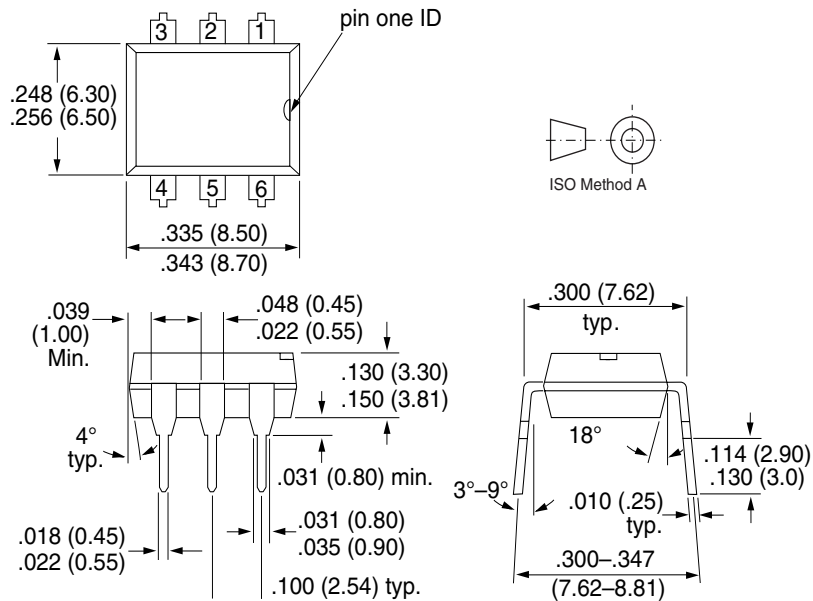

i178004

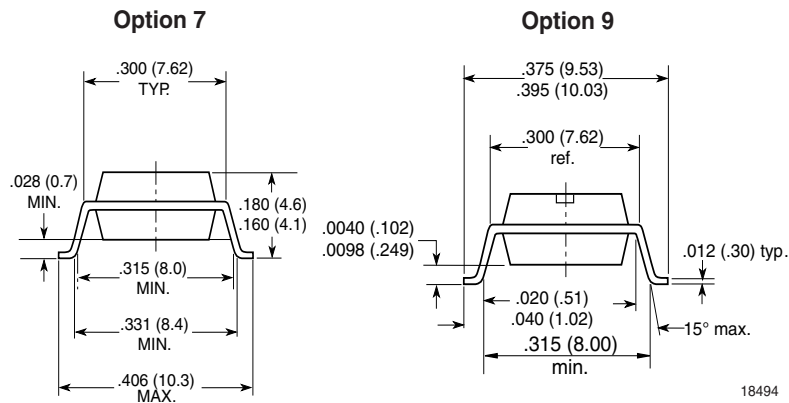

18494

### Ozone Depleting Substances Policy Statement

It is the policy of Vishay Semiconductor GmbH to

1. Meet all present and future national and international statutory requirements.
2. Regularly and continuously improve the performance of our products, processes, distribution and operating systems with respect to their impact on the health and safety of our employees and the public, as well as their impact on the environment.

It is particular concern to control or eliminate releases of those substances into the atmosphere which are known as ozone depleting substances (ODSs).

The Montreal Protocol (1987) and its London Amendments (1990) intend to severely restrict the use of ODSs and forbid their use within the next ten years. Various national and international initiatives are pressing for an earlier ban on these substances.

Vishay Semiconductor GmbH has been able to use its policy of continuous improvements to eliminate the use of ODSs listed in the following documents.

1. Annex A, B and list of transitional substances of the Montreal Protocol and the London Amendments respectively
2. Class I and II ozone depleting substances in the Clean Air Act Amendments of 1990 by the Environmental Protection Agency (EPA) in the USA
3. Council Decision 88/540/EEC and 91/690/EEC Annex A, B and C (transitional substances) respectively.

Vishay Semiconductor GmbH can certify that our semiconductors are not manufactured with ozone depleting substances and do not contain such substances.

We reserve the right to make changes to improve technical design  
and may do so without further notice.

Parameters can vary in different applications. All operating parameters must be validated for each customer application by the customer. Should the buyer use Vishay Semiconductors products for any unintended or unauthorized application, the buyer shall indemnify Vishay Semiconductors against all claims, costs, damages, and expenses, arising out of, directly or indirectly, any claim of personal damage, injury or death associated with such unintended or unauthorized use.

Vishay Semiconductor GmbH, P.O.B. 3535, D-74025 Heilbronn, Germany  
Telephone: 49 (0)7131 67 2831, Fax number: 49 (0)7131 67 2423