

All Band TV Tuner IC (VHF-CATV-UHF)

Description

The CXA3095N is a single chip TV tuner IC which performs as an oscillator, mixer for VHF-CATV and UHF bands. An IF amplifier is also provided.

This IC adopts a 24-pin SSOP package (0.8mm pitch) in response to the trend toward miniaturizing the tuner and automatic IC mounting.

This IC is the inverted product of the CXA3025N pin assignment.

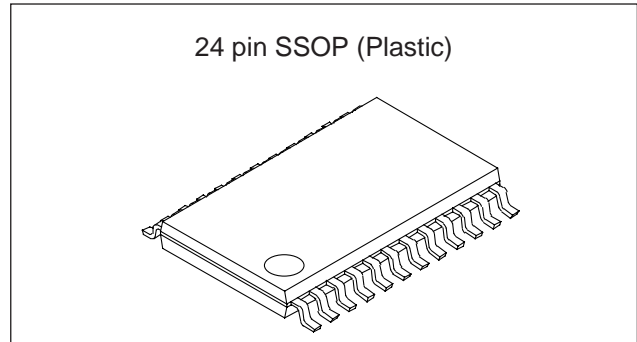

Features

- Low noise figure
- Superior cross modulation
- Low spurious
- Stable oscillating characteristics
- Local oscillator output for PLL
- Double tune filter connectable to MIX output
- Low thermal resistance package

Absolute Maximum Ratings

- Supply voltage V_{CC} 10.5 V
- Storage temperature T_{stg} -65 to +150 °C
- Allowable power dissipation P_D 1200 mW (when mounted on a board)

Structure

Bipolar silicon monolithic IC

Operating Conditions

- Supply voltage V_{CC} 9.0 ± 0.9 V
- Operating temperature T_{opr} -20 to +75 °C

Applications

- TV tuner
- CATV tuner
- VCR tuner

Block Diagram and Pin Configuration (Top View)

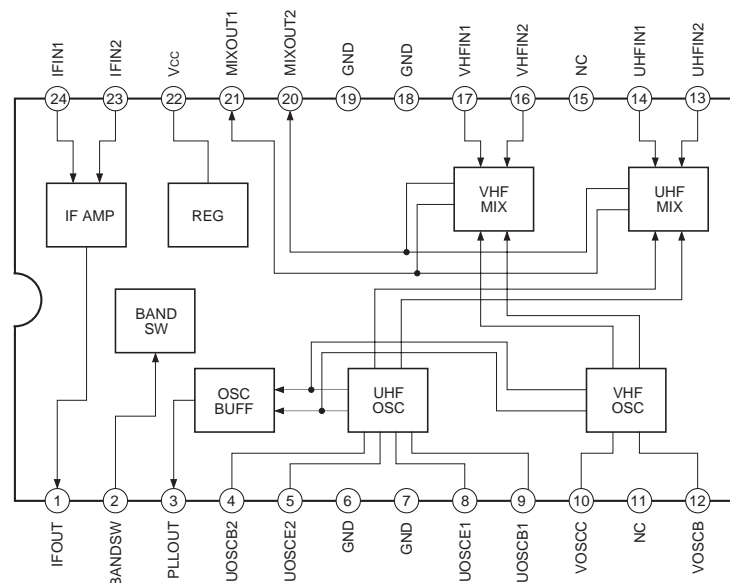

Sony reserves the right to change products and specifications without prior notice. This information does not convey any license by any implication or otherwise under any patents or other right. Application circuits shown, if any, are typical examples illustrating the operation of the devices. Sony cannot assume responsibility for any problems arising out of the use of these circuits.

Pin Description and Equivalent Circuit

Pin NO.	Symbol	Pin voltage typ (V)	Equivalent circuit	Description
1	IFOUT	Under VHF operation: 4.5		IF output.
		Under UHF operation: 4.5		
2	BANDSW	0		Band switching. UHF operation when 3V or more voltage is applied externally, and VHF operation when OPEN or 0.5V or less voltage is applied.
		3		
3	PLLOUT	5.8		PLL oscillator signal output.
		5.7		
4	UOSCB2	3.5		UHF oscillator.
5	UOSCE2	3.0		
8	UOSCE1	3.0		
		2.5		
9	UOSCB1	3.5		
		3.3		
10	VOSCC	6.3		VHF oscillator.
		9.0		
12	VOSCB	3.3		
		3.5		
11	NC			No connected.

Pin NO.	Symbol	Pin voltage typ (V)	Equivalent circuit	Description
13	UHFIN2	3.4		<p>UHF input. The balanced input to Pins 13 and 14, or a capacitor is connected at Pin 13 to GND and Pin 14 is used for input.</p>
		3.2		
14	UHFIN1	3.4		
		3.2		
15	NC			No connected.
16	VHFIN2	3.2		<p>VHF input. Normally a capacitor is connected at Pin 17 to GND and Pin 16 is used for input.</p>
		3.4		
17	VHFIN1	3.2		
		3.4		
6, 7 18, 19	GND	0		GND.
20	MIXOUT2	7.4		<p>Mixer output.</p>
		7.2		
21	MIXOUT1	7.4		
		7.2		
22	Vcc	9.0		Power supply.
23	IFIN2	—		<p>IF amplifier input.</p>
		—		
24	IFIN1	—		
		—		

Electrical Characteristics

See Electrical Characteristics Measurement Circuit (Ta = 25°C, Vcc = 9V)

Item	Symbol	Conditions	Min.	Typ.	Max.	Unit
Circuit current	IccV	VHF operation; no signal	38	53	63	mA
	IccU	UHF operation; no signal	37	51	62	mA
Conversion gain*1	CG1	VHF operation; f _{RF} = 55MHz; Input level -40dBm	17	20	23	dB
	CG2	VHF operation; f _{RF} = 360MHz; Input level -40dBm	18	21	24	dB
	CG3	UHF operation; f _{RF} = 360MHz; Input level -40dBm	23	26	29	dB
	CG4	UHF operation; f _{RF} = 800MHz; Input level -40dBm	23	26	29	dB
Noise figure*1 *2	NF1	VHF operation; f _{RF} = 55MHz		13	16	dB
	NF2	VHF operation; f _{RF} = 360MHz		12	15	dB
	NF3	UHF operation; f _{RF} = 360MHz		9	13	dB
	NF4	UHF operation; f _{RF} = 800MHz		9	13	dB
1% cross modulation*1 *3	CM1	VHF operation; f _D = 55MHz, f _{UD} = ±12MHz	99	102		dBμ
	CM2	VHF operation; f _D = 360MHz, f _{UD} = ±12MHz	97	100		dBμ
	CM3	UHF operation; f _D = 360MHz, f _{UD} = ±12MHz	91	94		dBμ
	CM4	UHF operation; f _D = 800MHz, f _{UD} = ±12MHz	89	92		dBμ
Max. output power	Pomax (sat)	50Ω load	+8	+10		dBm
Switch ON drift*4	Δfsw1	VHF operation; fosc = 100MHz			±200	kHz
	Δfsw2	VHF operation; fosc = 405MHz			±300	kHz
	Δfsw3	UHF operation; fosc = 405MHz			±300	kHz
	Δfsw4	UHF operation; fosc = 845MHz			±300	kHz
+B supply voltage drift*5	Δfst1	VHF operation; fosc = 100MHz			±100	kHz
	Δfst2	VHF operation; fosc = 405MHz			±200	kHz
	Δfst3	UHF operation; fosc = 405MHz			±150	kHz
	Δfst4	UHF operation; fosc = 845MHz			±150	kHz
PLL OUT output power	PoscV	VHF operation; 50Ω load	-20	-10		dBm
	PoscU	UHF operation; 50Ω load	-20	-10		dBm
Band switch voltage	VswV	VHF operation	0		0.5	V
	VswU	UHF operation	3		10.5	V

*1 Measured value for untuned inputs.

*2 Noise figure is the direct-reading value of NF meter in DSB.

*3 Desired signal (f_D) input level is -33dBm. Undesired signal (f_{UD}) is 100kHz, 30%AM at ±12MHz.

The measurement value is undesired signal level, it measured with a spectrum analyzer at S/I = 46dB.

*4 Frequency variation form 3 seconds to 3 minutes after switch ON.

*5 Frequency variation when Vcc = 9V ± 5% variation.

Description of Operation (See Electrical Characteristics Measurement Circuit.)**VHF oscillator circuit**

The differential oscillator circuit with an output at Pin 10 and an input at Pin 12.

Connect an LC resonance circuit comprising a varicap diode to Pin 10 through a coupling capacitor.

The positive feedback from the resonance circuit is applied to Pin 12 through a feedback capacitor to execute oscillation. Note that if a parasitic capacitance across Pins 10 and 12 is too large, it may cause undesired stray oscillation.

VHF mixer circuit

This is a common emitter type double-balanced mixer having small leakage of local oscillation signal. The RF signal is input to Pins 16 and 17. In normal use, the signal is input to one pin while the other pin is connected to GND by decoupling capacitor. The RF signal is converted to IF frequency with the signal supplied from oscillator. The converted RF is sent to the IF frequency and output to Pins 20 and 21.

UHF oscillator circuit

UHF oscillator is formed from two collector-grounded Colpitts oscillators, and oscillation is provided at the differential input through an LC resonator circuit comprising a varicap diode. LC resonator comprising a varicap diode is connected across Pins 4, 5, 8, and 9.

UHF mixer circuit

The double-balanced mixer like the VHF mixer is adopted. The RF signal is input to Pins 13 and 14. There is a balanced differential input from pre-stage double tune circuit, or an unbalanced input to Pin 14 with the capacitor connected at Pin 13 to GND. Otherwise, the conditions and usage are the same as those for the VHF mixer circuit.

IF amplifier circuit

The frequency converted signal at mixer is output from Pins 20 and 21, and input to IF input pins 23 and 24 through the external IF tune circuit. As an IF tune circuit, single tune circuit like the electrical characteristics measurement circuit or double tune circuit can be connected. The amplified signal at IF amplifier is output to Pin 1. The output impedance is approximately 75Ω .

Also, input block of the IF amplifier has a built-in coupling capacitor, and direct connection with the mixer output is possible.

UHF/VHF switch circuit

UHF operation is chosen by applying 3V or more voltage to Pin 2; VHF operation for 0V or OPEN.

PLL oscillator signal output circuit

Oscillation signal is output to PLLOUT through buffer amplifier. The resistance connected to the output pin is for current adjustment flowing to buffer amplifier. The resistance value is adjusted depending on the connected load, and output distortion can be minimized.

Notes on Usage

Care should be taken such as grounding in placing external parts because high frequencies are present. GND (Pins 6, 7, 18, and 19) are served both as heat dissipation pins, and adjust accordingly to prevent heat problems.

Please concern for damage by static electricity for high frequency input/output pins.

Example of Representative Characteristics

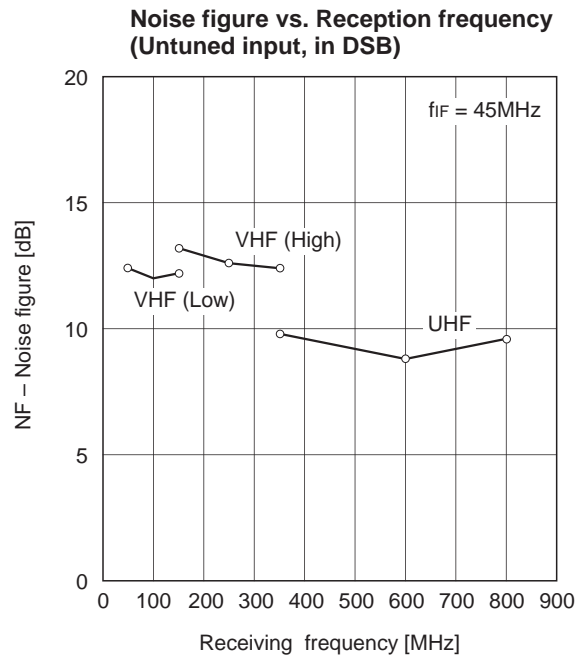
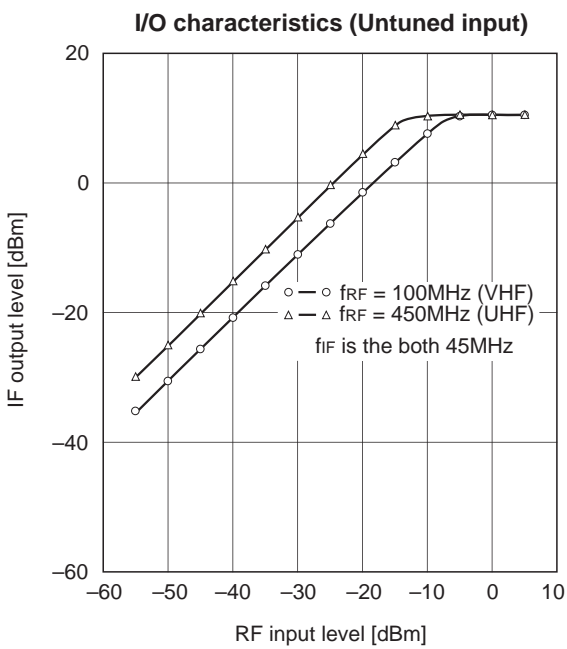
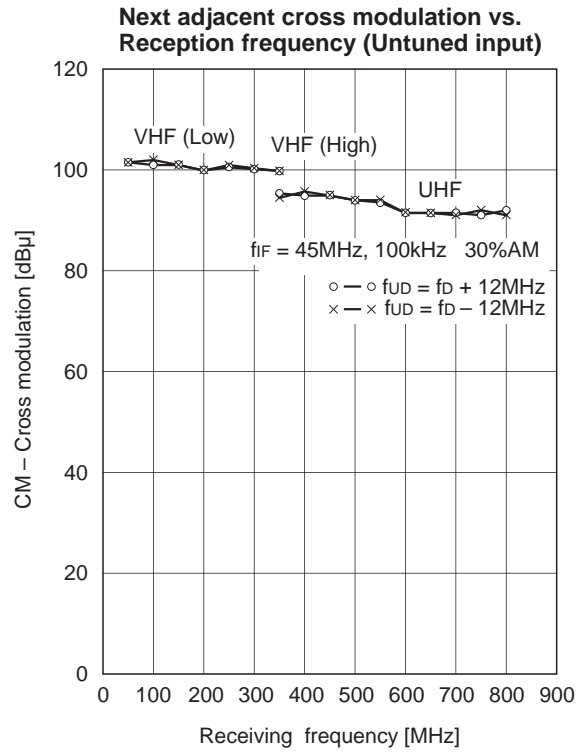
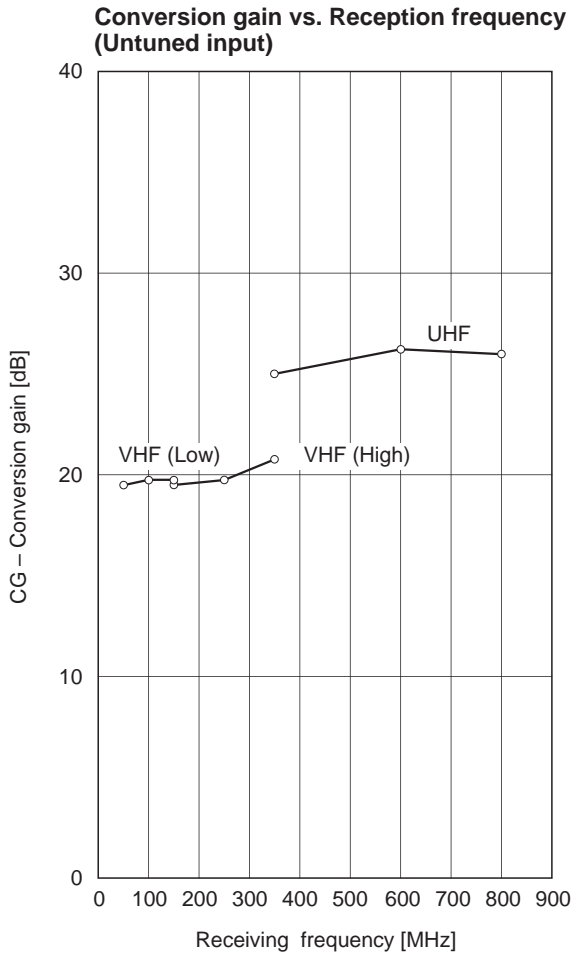

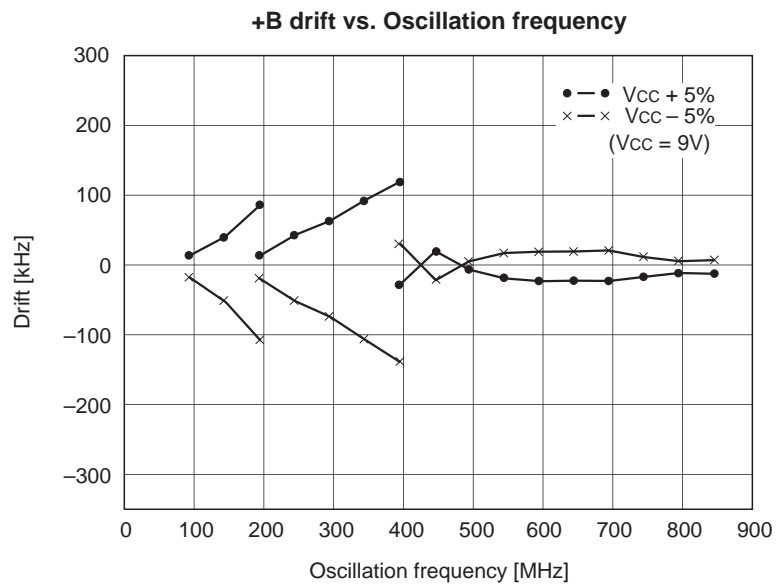
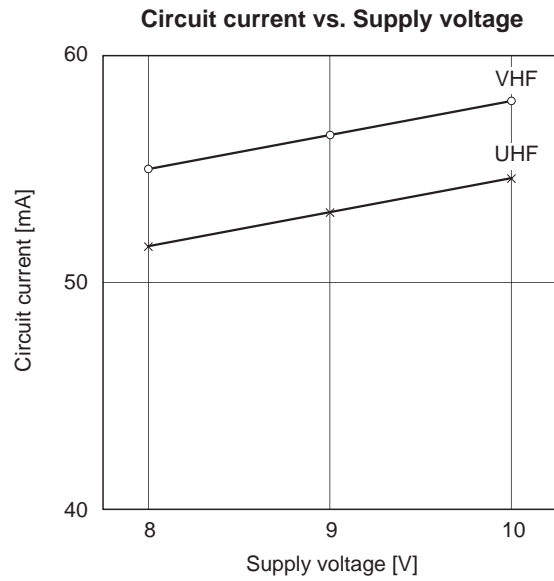

PLLOUT level (fundamental harmonic and secondary higher harmonic) vs. Oscillation frequency

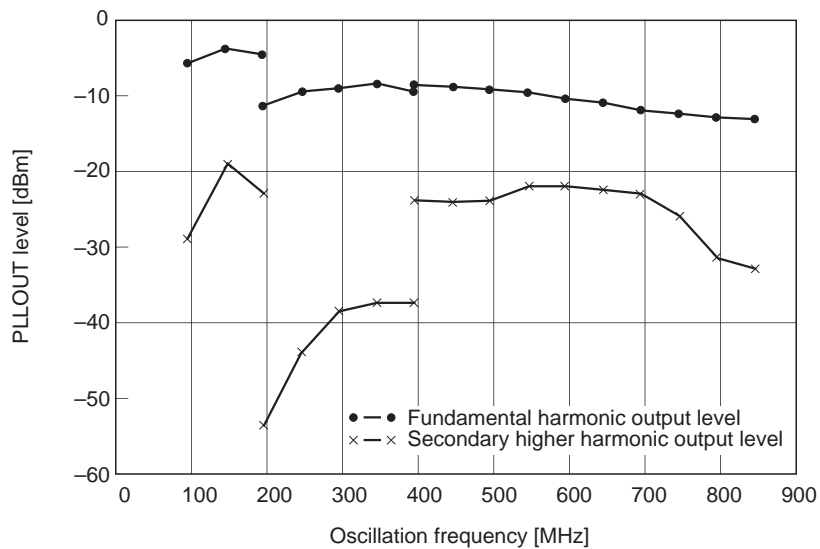

VHF Input Impedance

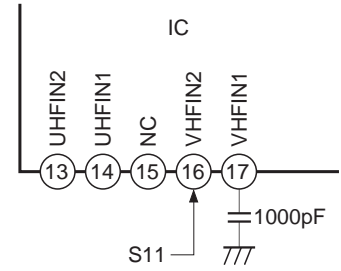
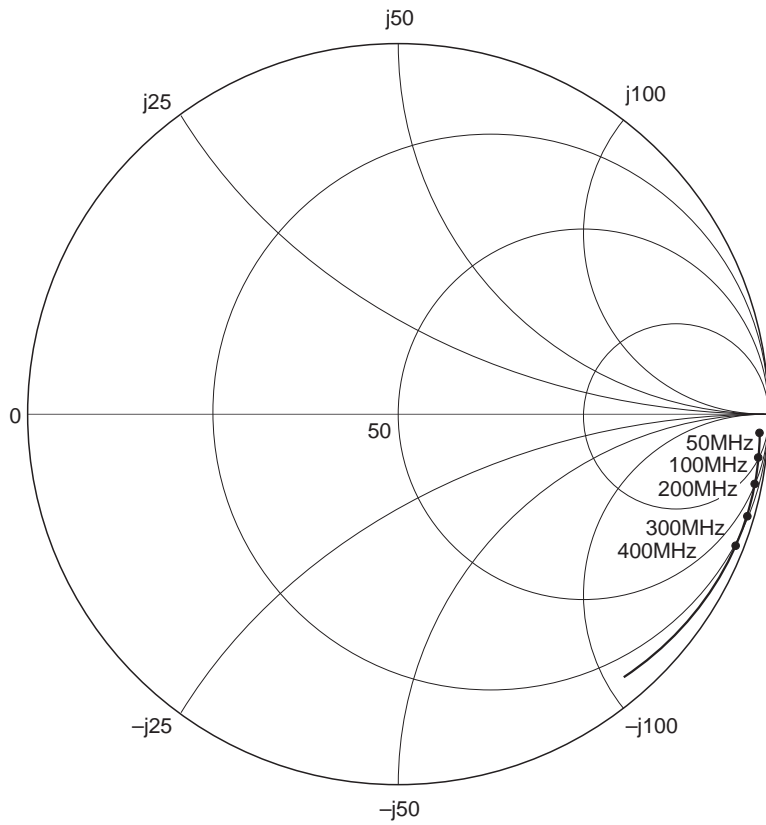

UHF Input Impedance

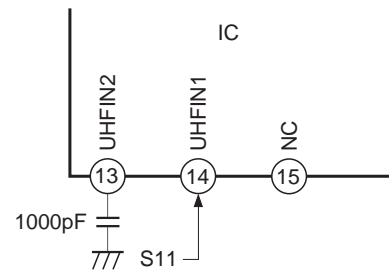
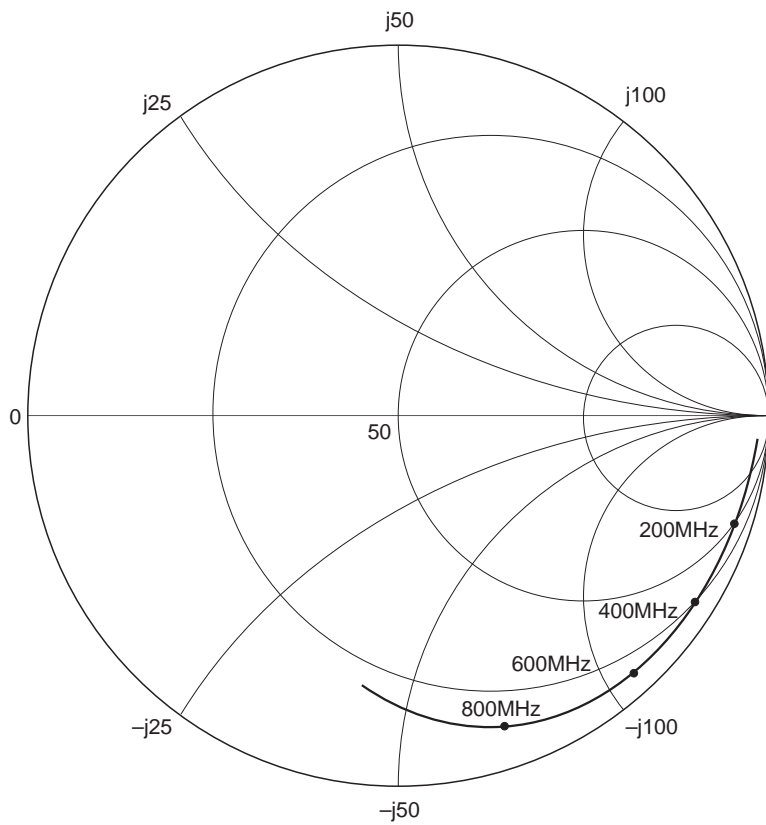

IF Output Impedance

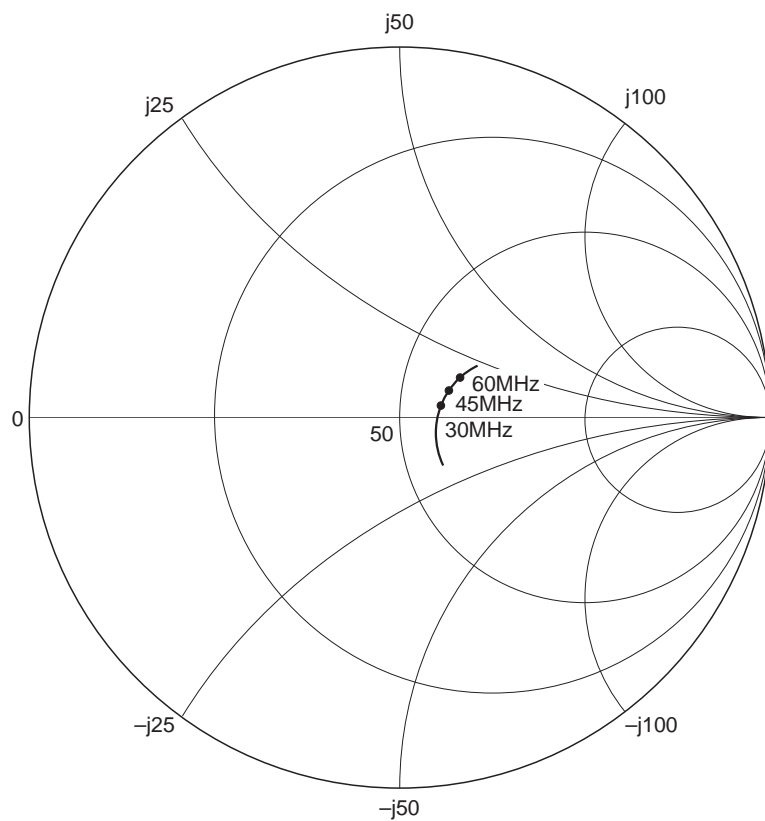

PLL Output Impedance

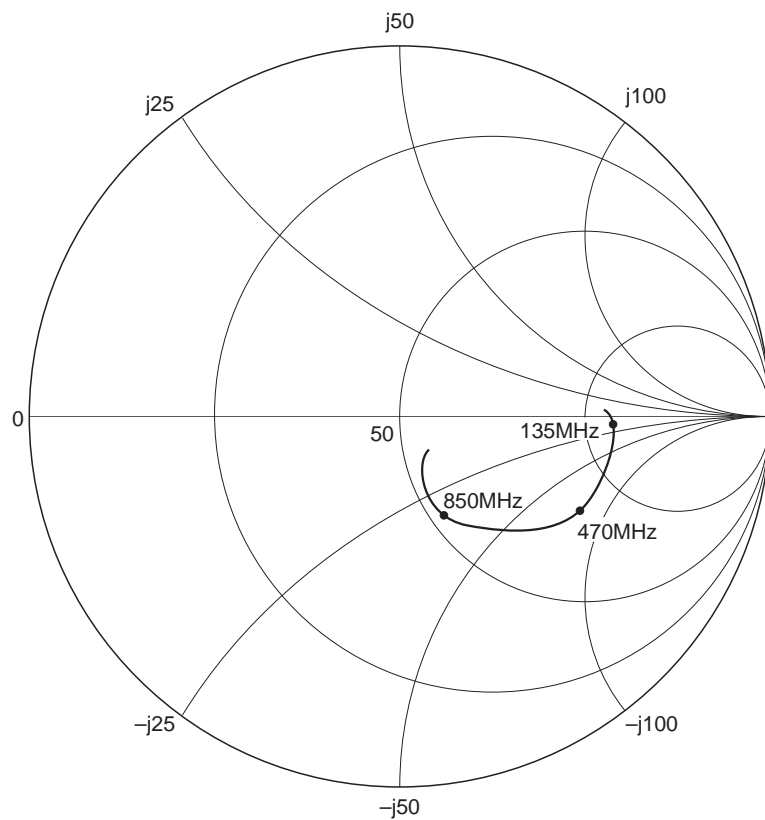

Package Outline

Unit : mm

24PIN SSOP (PLASTIC)

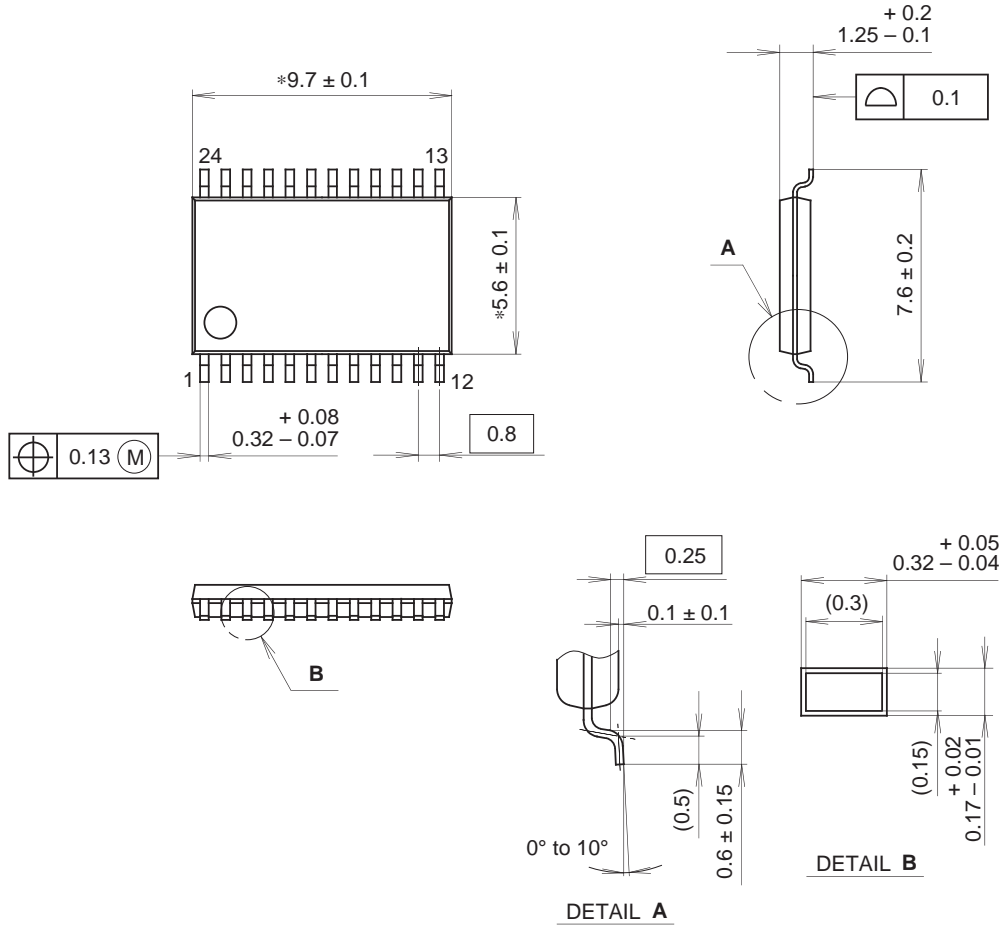

NOTE: Dimension "*" does not include mold protrusion.

PACKAGE STRUCTURE

SONY CODE	SSOP-24P-L03
EIAJ CODE	SSOP024-P-0056
JEDEC CODE	_____

PACKAGE MATERIAL	EPOXY RESIN
LEAD TREATMENT	PALLADIUM PLATING
LEAD MATERIAL	COPPER ALLOY
PACKAGE MASS	0.1g