

Read/Write Amplifier (with Built-in Filters) for FDDs

Description

The CXA3010Q is a monolithic IC designed for use with three-mode Floppy Disk Drives, and contains a read circuit (with a four-mode filter system), a write circuit, an erase circuit, and a supply voltage detection circuit, all on a single chip.

Features

- Single 5V power supply
- Filter system can be switched among four modes: 1M, 1.6M/2M, which are each inner track/outer track
- Filter characteristics can be set to Chebyshev (1dB ripple) for 1.6M, 2M/inner track only, and to Butterworth for the other modes
- A custom selection can be made between Chebyshev (1dB ripple) and Butterworth for the filter characteristics for 1.6M, 2M/inner track only
- Permits customization of the fc ratio
- Low preamplifier input conversion noise voltage of $2.0nV/\sqrt{Hz}$ (typ.) keeps read data output jitter to a minimum
- Preamplifier voltage gain can be switched between 39dB and 45dB
- In inner track mode (OTF = Low), the voltage gain is boosted by 3dB, making it possible to minimize peak shift in inner tracks.
- Time domain filter can be switched between two modes: 1M, 1.6M/2M
- Write current can be switched among three modes: 1M/1.6M/2M. The inner/outer track current ratio is fixed for each mode, but can be customized.
- Erase current can be set by an external resistor, and remains constant. In addition, the current rise time T_r and fall time T_f are determined according to the head inductance and current. (Refer to page 20.)
- Damping resistor can be built in. Resistance can be customized between $2k\Omega$ and $15k\Omega$ in $1k\Omega$ steps. A damping resistor can not be connected to this IC, however.
- Supply voltage detection circuit

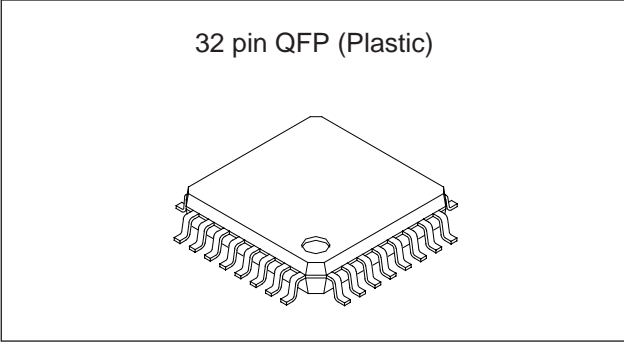

Applications

Three-mode FDDs

Structure

Bipolar silicon monolithic IC

Absolute Maximum Ratings ($T_a = 25^\circ C$)

- Supply voltage V_{cc} 7.0 V
- Operating temperature T_{opr} -20 to $+75$ $^\circ C$
- Storage temperature T_{stg} -65 to $+150$ $^\circ C$
- Allowable power dissipation P_D 500 mW
- Digital signal input pin Input voltage -0.5 to $V_{cc} + 0.3$ V
- Power ON output voltage applied $V_{cc} + 0.3$ V
- Erase output voltage applied $V_{cc} + 0.3$ V
- Write head voltage applied 15 V
- Write current I_w 20 mAo-p
- Erase current I_E 30 mA
- Power on output current 7 mA

Operating Conditions

Supply voltage 4.4 to 6.0 V

Sony reserves the right to change products and specifications without prior notice. This information does not convey any license by any implication or otherwise under any patents or other right. Application circuits shown, if any, are typical examples illustrating the operation of the devices. Sony cannot assume responsibility for any problems arising out of the use of these circuits.

Block Diagram and Pin Configuration

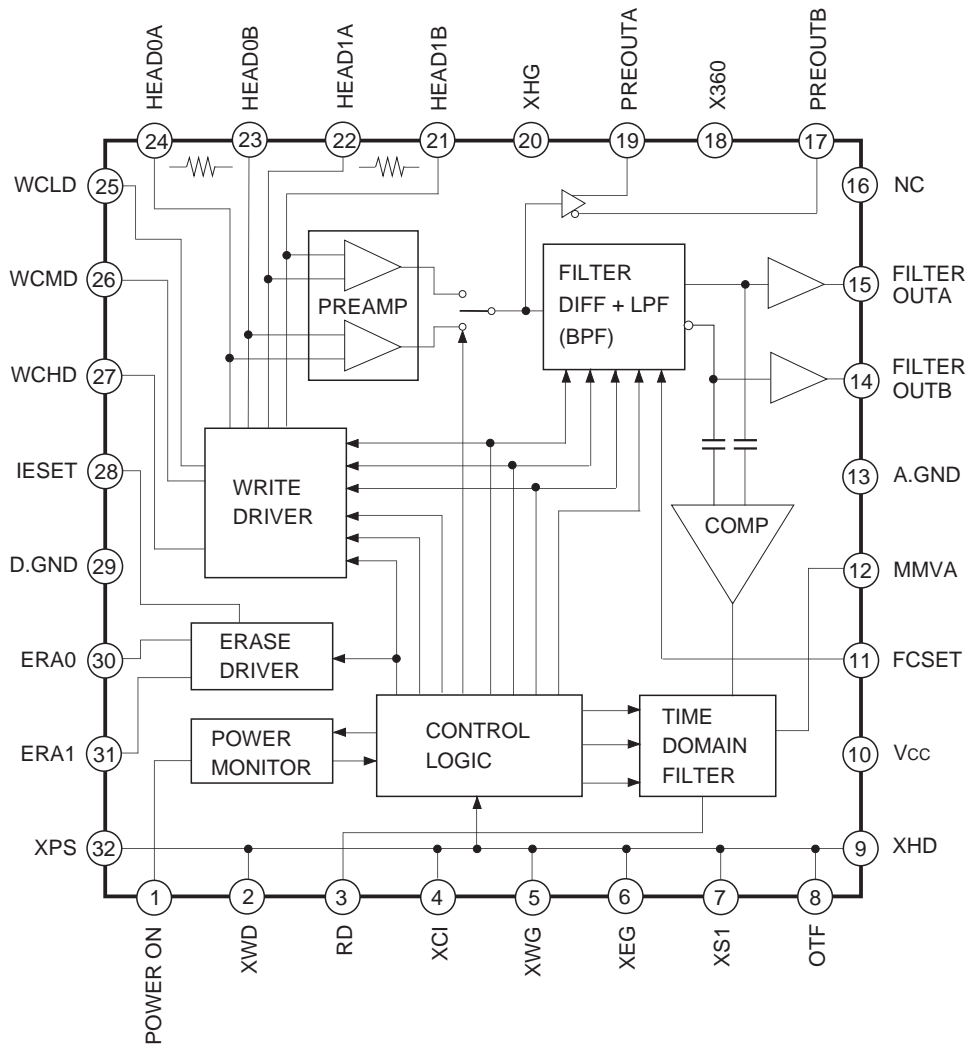

Pin Description

Pin No.	Symbol	Pin voltage	Equivalent circuit	Description
1	POWER ON	—		<p>Reduced voltage detection output. This is an open collector pin that outputs a low signal when Vcc is below the specified value.</p>
2	XWD	—		<p>Write data input. This pin is a Schmitt-type input that is triggered when the logical voltage goes from High to Low.</p>
3	RD	—		<p>Read data output. This pin is active when the logical voltage of the write gate signal and the erase gate signal is High.</p>
4	XCI	—		<p>Write current control. The write current increases when the logical voltage is Low.</p>
5	XWG	—		<p>Write gate signal input. The write system becomes active when the logical voltage is Low.</p>
6	XEG	—		<p>Erase gate signal input. The erase system becomes active when the logical voltage is Low.</p>
7	XS1	—		<p>Head side switching signal input. The HEAD1 system is active when the logical voltage is Low, and the HEAD0 system is active when the logical voltage is High, but only when the logical voltage for the write gate and the erase gate is High.</p>
8	OTF	—		<p>Filter inner track/outer track mode control. Inner track mode is selected when the logical voltage is Low.</p>
9	XHD	—	<p>Filter, time domain filter and write current 1M/2M mode control. 2M mode is selected when the logical voltage is Low.</p>	

Pin No.	Symbol	Pin voltage	Equivalent circuit	Description
18	X360	—		Filter, time domain filter and write current 1M/1.6M mode control. 1.6M mode is selected when the logical voltage is Low.
20	XHG	—		Preamplifier voltage gain selection. Gain is boosted by 6dB when the logical voltage is Low compared to when the logical voltage is High.
10	Vcc	—		Power supply (5V) connection.
11	FCSET	3.8V		Filter cutoff frequency setting resistor connection. Connect the filter cutoff frequency setting resistor R_F between this pin and Vcc in order to set the cutoff frequency.
12	MMVA	0.5V		Time domain filter 1st monostable multivibrator pulse width setting. Connect the 1st monostable multivibrator pulse width setting resistor R_A between this pin and A.GND.
13	A.GND	—		Analog system GND connection.
14	FILTER OUTB	3.4V		Filter differential outputs.
15	FILTER OUTA	3.4V		
16	(NC)	—		Not connected.
17	PRE OUTB	3.4V		Preamplifier differential outputs.
19	PRE OUTA	3.4V		

Pin No.	Symbol	Pin voltage	Equivalent circuit	Description
21	HEAD 1B	—		<p>Magnetic head input/output connections. Connect the recording/playback magnetic head to these pins, and connect the center tap to V_{CC}. When the logical voltage for Pin 7 (XS1) is Low, the HEAD1 system is active; when the logical voltage is High, the HEAD0 system is active.</p>
22	HEAD 1A	—		
23	HEAD 0B	—		
24	HEAD 0A	—		
25	WCLD	5V when XWG = High		<p>1M write current setting resistor connection. Connect the write current setting resistor R_{WLD} between this pin and V_{CC} to set the write current.</p>
26	WCMD	3.8V when XWG = Low		<p>1.6M write current setting resistor connection. Connect the write current setting resistor R_{WMD} between this pin and V_{CC} to set the write current.</p>
27	WCHD	—		<p>2M write current setting resistor connection. Connect the write current setting resistor R_{WHD} between this pin and V_{CC} to set the write current.</p>
28	IESET	5V when XEG = High 3.8V when XEG = Low		<p>Erase current setting resistor connection. Connect the erase current setting resistor R_E between this pin and V_{CC} to set the erase current.</p>
29	D.GND	—		Digital system GND connection.
30	ERA0	—		Erase current connection for the HEAD0 system.
31	ERA1	—		Erase current connection for the HEAD1 system.

Pin No.	Symbol	Pin voltage	Equivalent circuit	Description
32	XPS	—		<p>Power saving signal input. When the logical voltage is Low, the IC is in power saving mode. In power saving mode, only the power supply on/off detector operates.</p>

Electrical Characteristics

Current Consumption

(Ta = 25°C, Vcc = 5V)

Item	Symbol	Conditions	Measurement circuit	Measurement Point	Min.	Typ.	Max.	Unit
Current consumption in read mode	ICCR	XWG = High	—	—	16	26	36	mA
Current consumption in write/erase mode	ICCWE	XWG = Low, XEG = Low	—	—	7	13	19	mA
Current consumption in power saving mode	ICCPS	XPS = Low	—	—	—	0.95	1.9	mA

Power Supply Monitoring System

(Ta = 25°C)

Item	Symbol	Conditions	Measurement circuit	Measurement Point	Min.	Typ.	Max.	Unit
Power supply on/off detector threshold voltage	VTH		—	—	3.5	3.9	4.3	V
Power on output saturation voltage	VSP	Vcc = 3.5V I = 1mA	—	—	—	—	0.5	V

Read System

(Ta = 25°C, Vcc = 5V)

Item	Symbol	Conditions	Measurement circuit	Measurement Point	Min.	Typ.	Max.	Unit
Preamplifier voltage gain Low gain/outer track	GVLO	f = 100kHz OTF = High, XHG = High	1	D, E	37.1	39.0	40.6	dB
Preamplifier voltage gain Low gain/inner track	GVLI	f = 100kHz OTF = Low, XHG = High	1	D, E	40.1	42.0	43.6	dB
Preamplifier voltage gain High gain/outer track	GVHO	f = 100kHz OTF = High, XHG = Low	1	D, E	43.1	45.0	46.6	dB
Preamplifier voltage gain High gain/inner track	GVHI	f = 100kHz OTF = Low, XHG = Low	1	D, E	46.1	48.0	49.6	dB
Preamplifier frequency response	BW	Gv/Gv (100kHz) = -3dB	1	D, E	5	—	—	MHz
Preamplifier input conversion noise voltage	EN	Band Width = 400Hz to 1MHz, Vi = 0	1	D, E	—	2.0	2.9	nV/√Hz
Preamplifier differential output offset voltage	VOFSP	Vi = 0	1	D, E	-500	—	+500	mV
Filter differential output offset voltage	VOFSF	Vi = 0	1	B, C	-100	—	+100	mV
Filter differential output voltage amplitude	VOF		1	B, C	2.8	—	—	Vp-p

Read System

(Ta = 25°C, Vcc = 5V)

Item	Symbol	Conditions	Measurement circuit	Measurement Point	Min.	Typ.	Max.	Unit
Time domain filter monostable multivibrator pulse width	T1	X360 = High, XHD = High (1M mode)	1	A, F	2.25	2.5	2.75	μs
		X360 = Low, XHD = High (1.6M mode) or X360 = X, XHD = Low (2M mode) Refer to Fig. 1	1	A, F	1.13	1.25	1.38	μs
Read data pulse width	T2	Refer to Fig. 1	1	A	260	400	540	ns
Read data output low output voltage	VOL	I _{OL} = 2mA	1	A	—	—	0.5	V
Read data output high output voltage	VOH	I _{OH} = -0.4mA	1	A	2.8	—	—	V
Read data output* ¹ rise time	tr	R _L = 2kΩ C _L = 20pF	1	A	—	—	100	ns
Read data output* ¹ fall time	tf	R _L = 2kΩ C _L = 20pF	1	A	—	—	100	ns
Peak shift* ²	PS	V _I = 0.25mVp-p to 3.5mVp-p XHG = Low, XHD = Low OTF = Low f = 125kHz, 2M/ inner track mode Refer to Fig. 1	1	A	—	—	1	%

*¹ Read data output: 0.5V to 2.4V*² Signal input levelLow gain/outer track: V_I = 0.5mVp-p to 10mVp-pLow gain/inner track: V_I = 0.5mVp-p to 7mVp-pHigh gain/outer track: V_I = 0.25mVp-p to 5mVp-pHigh gain/inner track: V_I = 0.25mVp-p to 3.5mVp-p

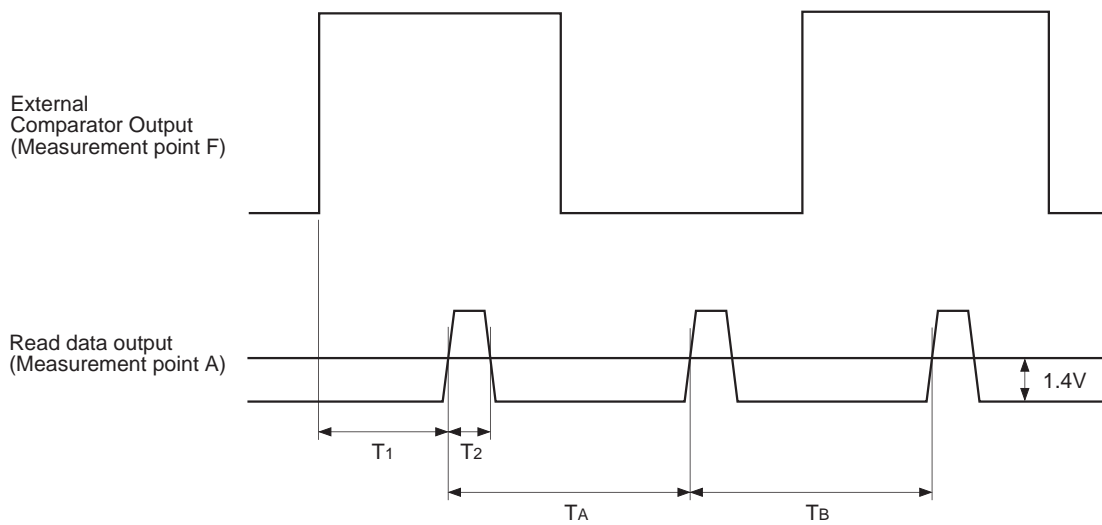

Fig. 1 1st and 2nd monostable multivibrator pulse width precision and peak shift measurement conditions

- 1st monostable multivibrator pulse width precision

When X360 = High and XHD = High:

$$ETM1 = \left(\frac{T_1}{2.5\mu\text{s}} - 1 \right) \times 100 [\%]$$

When X360 = Low and XHD = High, or X360 = X and XHD = Low:

$$ETM1' = \left(\frac{T_1}{1.25\mu\text{s}} - 1 \right) \times 100 [\%]$$

- 1st monostable multivibrator pulse width = T_2
- Peak shift

$$PS = \frac{1}{2} \left| \frac{T_A - T_B}{T_A + T_B} \right| \times 100 [\%]$$

Read System (Filters)

(Ta = 25°C, Vcc = 5V)

Item		Symbol	Conditions	Measurement circuit	Measurement Point	Min.	Typ.	Max.	Unit
1M outer track	Peak frequency	f ₀₁	X360 = High XHD = High OTF = High	1	B, C	153.0	170.0	187.0	kHz
	Peak voltage gain* ³	G _{p1}	Refer to Fig. 2 at f ₀₁	1	D, E B, C	4.3	6.2	7.8	dB
	Frequency response (1)	G ₁₁	Refer to Fig. 2 at 1/3f ₀₁	1	B, C	-7.6	-7.1	-6.6	dB
	Frequency response (2)	G ₁₂	Refer to Fig. 2 at 3f ₀₁	1	B, C	-24.7	-22.8	-21.2	dB
1M inner track	Peak frequency	f ₀₂	X360 = High XHD = High OTF = Low	1	B, C	163.8	182.0	200.2	kHz
	Peak voltage gain* ³	G _{p2}	Refer to Fig. 2 at f ₀₂	1	D, E B, C	4.3	6.2	7.8	dB
	Frequency response (1)	G ₂₁	Refer to Fig. 2 at 1/3f ₀₂	1	B, C	-7.6	-7.1	-6.6	dB
	Frequency response (2)	G ₂₂	Refer to Fig. 2 at 3f ₀₂	1	B, C	-24.7	-22.8	-21.2	dB
1.6M/ 2M outer track	Peak frequency	f ₀₃	X360 = Low XHD = High OTF = High (1.6M/outer track) or X360 = X XHD = Low OTF = High (2M/outer track)	1	B, C	288.0	320.0	352.0	kHz
	Peak voltage gain* ³	G _{p3}	Refer to Fig. 2 at f ₀₃	1	D, E B, C	4.4	6.3	7.9	dB
	Frequency response (1)	G ₃₁	Refer to Fig. 2 at 1/3f ₀₃	1	B, C	-7.6	-7.1	-6.6	dB
	Frequency response (2)	G ₃₂	Refer to Fig. 2 at 3f ₀₃	1	B, C	-25.0	-23.1	-21.5	dB

Item	Symbol	Conditions	Measurement circuit	Measurement Point	Min.	Typ.	Max.	Unit
1.6M/ 2M inner track	Peak frequency	f_{04} X360 = Low XHD = High OTF = Low (1.6M/inner track) or X360 = X XHD = Low OTF = Low (2M/inner track)	1	B, C	310.5	345.0	379.5	kHz
	Peak voltage gain*3	G_{p4} Refer to Fig. 2 at f_{04}	1	D, E B, C	5.9	7.8	9.4	dB
	Frequency response (1)	G_{41} Refer to Fig. 2 at $1/3f_{04}$	1	B, C	-8.5	-8.0	-7.5	dB
	Frequency response (2)	G_{42} Refer to Fig. 2 at $3f_{04}$	1	B, C	-36.9	-35.0	-33.4	dB

*3 $G_{pn} = 20 \log_{10} (V_{Filterout}/V_{preout})$
 $V_{Filterout}$ = Filter differential output voltage
 (n = 1 to 4)

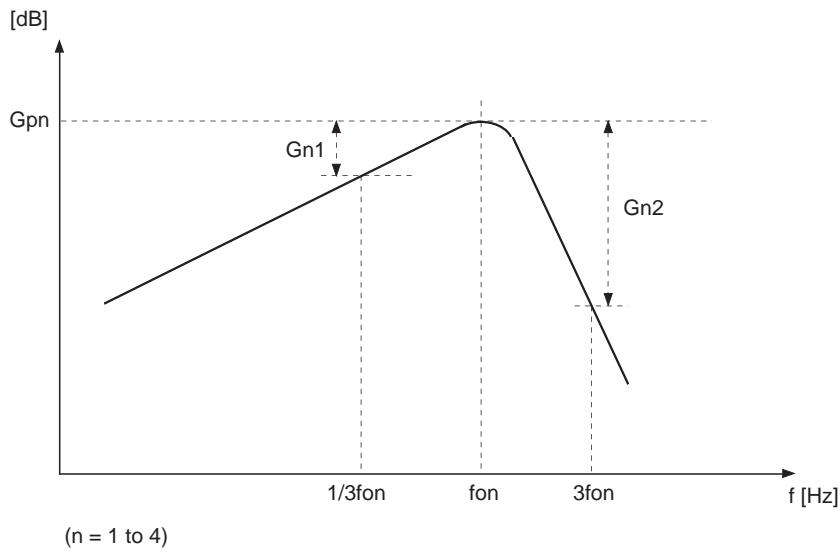

Fig. 2. Filter frequency response measurement conditions

Write/Erase System

(Ta = 25°C, Vcc = 5V)

Item	Symbol	Conditions	Measurement circuit	Measurement Point	Min.	Typ.	Max.	Unit
Damping resistor precision	RD	Vcc = 0V SW2 = b	2	J', K' L', M'	-20	—	+20	%
Write current output precision*4	EW	XWG = Low RW = 1.3kΩ	2	J, K L, M	-7	—	+7	%
Write current output unbalance	DW	XWG = Low RW = 1.3kΩ	2	J, K L, M	-1	—	+1	%
Head I/O pin leak current for writes	ILKW	XWG = Low	2	J, K L, M	—	—	10	μA
Write head pin current at saturation	ISW	XWG = Low RW = 1.3kΩ VSW = 1V SW1 = b	2	J, K L, M	2.47	2.70	2.97	mAo-p
Erase current output precision*5	EE	XEG = Low RE = 1.3kΩ	2	N, O	-10	—	+10	%
Erase current output pin leak current	ILKE	XEG = Low	2	N, O	—	—	10	μA
Erase current rise time*6	TRE	Defined at 10% to 90% of I _E	2	N', O'	0.6	1.3	2.1	μs
Erase current fall time*6	TFE	Defined at 90% to 10% of I _E	2	N', O'	0.6	1.3	2.1	μs

*4 Write current output precision $E_w = \left(\frac{I_w}{2.72\text{mAo-p}} - 1 \right) \times 100$ [%]

*5 Erase current output precision $E_E = \left(\frac{I_E}{9.08\text{mA}} - 1 \right) \times 100$ [%]

*6 Erase current rise/fall times show the values when the output pin is shorted with the power supply.

Logic Input Block

(Ta = 25°C, Vcc = 5V)

Item	Symbol	Conditions	Measurement circuit	Measurement Point	Min.	Typ.	Max.	Unit
Digital signal input low input voltage	VLD		2	BCDE FGHIP	—	—	0.8	V
Digital signal input high input voltage	VHD		2	BCDE FGHIP	2.0	—	—	V
Schmitt-type digital signal input low input voltage	VLSD		2	A	—	—	0.8	V
Schmitt-type digital signal input high input voltage	VHSD		2	A	2.0	—	—	V
Digital signal input low input current	ILD	VL = 0V	2	ABCDE FGHIP	-20	—	—	μA
Digital signal input high input current	IHD	VH = 5V	2	ABCDE FGHIP	—	—	10	μA

Electrical Characteristics Measurement Circuit 1

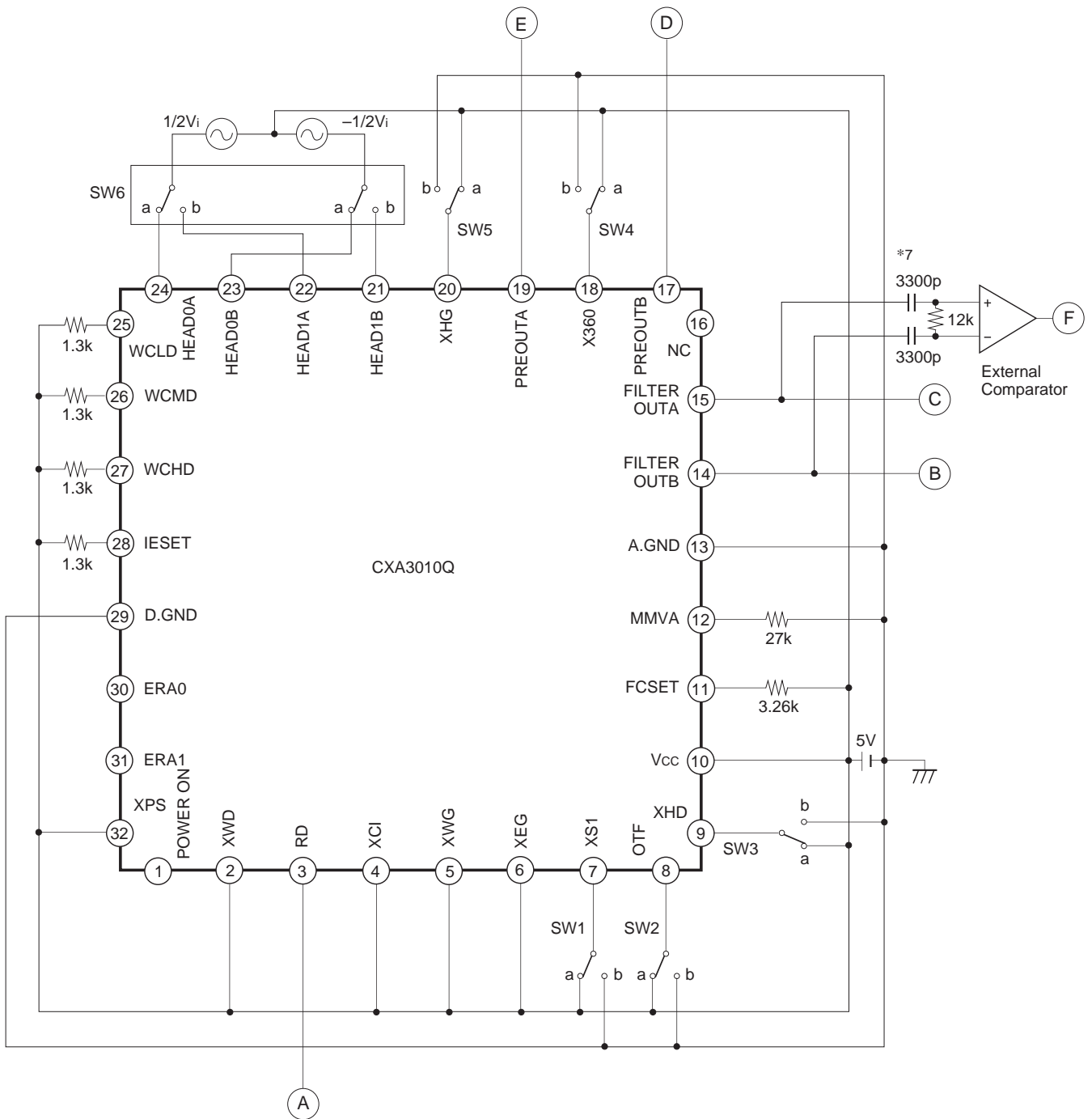

Note) Unless otherwise specified, switches are assumed to be set to "a".

*7 CR time constant of external comparator input stage is equivalent to the time constant of comparator with a built-in IC.

Electrical Characteristics Measurement Circuit 2

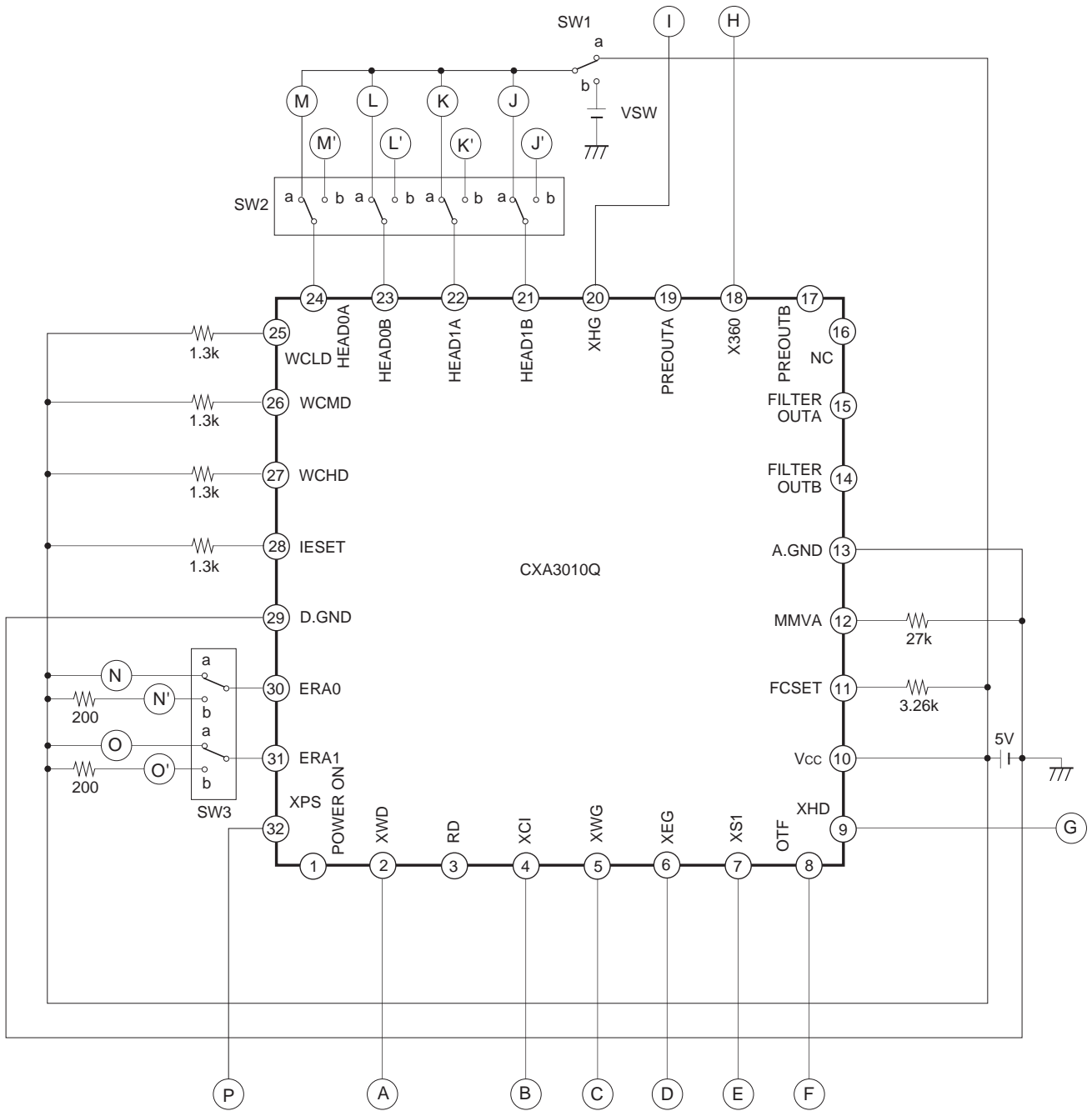

Note) Unless otherwise specified, switches are assumed to be set to "a".

Description of Operation

(1) Read system

Preamplifier

The preamplifier amplifies input signals. The voltage gain can be switched between 39dB and 45dB, using Pin 20. In addition, an additional 3dB boost in the voltage gain is possible by setting Pin 8 low.

Filters

The filters differentiate the signals amplified by the preamplifier. The high-band noise components are attenuated by the low-pass filter. The filters can be switched among four modes, depending on the settings of Pins 8, 9 and 18. In 1M/outer track mode, the peak frequency f_{01} is set by external resistor R_F .

f_0 for the other three modes is switched by the internal settings of the IC, with f_{01} used as a reference (1.00).

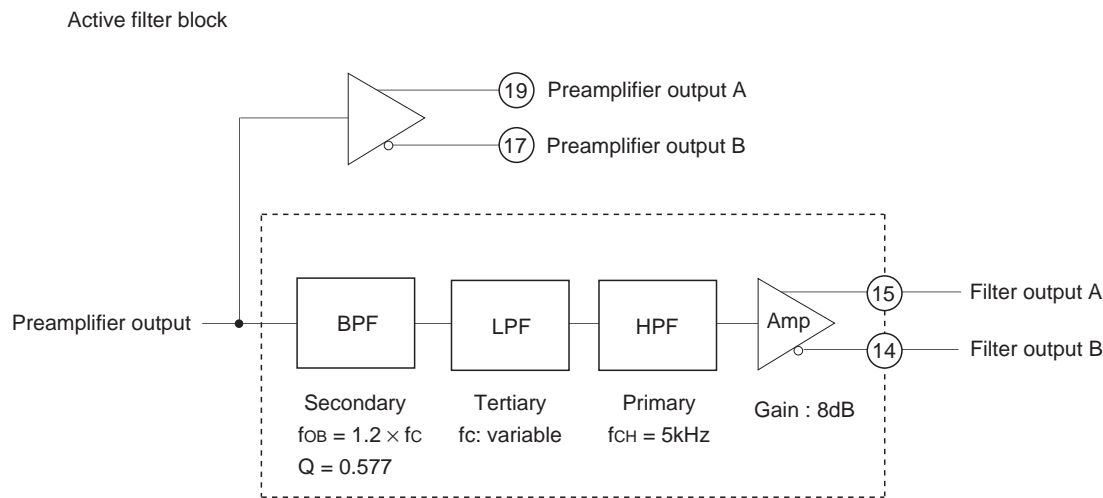

The center frequency f_{0B} of the BPF is fixed to 1.2 times the cutoff frequency f_0 of the LPF. The LPF characteristics are set to Chebyshev (1dB ripple) for 1.6M, 2M/inner track mode only, and to Butterworth for all other modes.

Pin8 OTF	Pin9 XHD	Pin18 X360	LPF characteristics	f_0 ratio
H	H	H	1M/outer track: Butterworth	1.00
L	H	H	1M/inner track: Butterworth	1.07
H	H	L	1.6M/outer track: Butterworth	1.88
L	H	L	1.6M/inner track: Chebyshev 1dB ripple	2.03
H	L	X	2M/outer track: Butterworth	1.88
L	L	X	2M/inner track: Chebyshev 1dB ripple	2.03

The formula for determining the peak frequency f_{01} for 1M/outer track mode is shown below:

$$f_{01} = 534/R_F + 6.2 \text{ [kHz]} \quad R_F: \text{ filter setting resistance [k}\Omega\text{]}$$

Comparator

The comparator detects the crosspoint of the filter differential output.

Time domain filter

The time domain filter converts the comparator output to read data.

This filter is equipped with two monostable multivibrators. 1st monostable multivibrator eliminates unnecessary pulses, and 2nd monostable multivibrator determines the pulse width of the read data.

The 1st monostable multivibrator pulse width T1 is determined by the resistor RA between Pin 12 and A.GND. T1 can be switched as follows by the settings of Pins 9 and 18:

When XHD = High and X360 = High $T1(1M) = 88RA + 124$ [ns] RA [kΩ]

When XHD = High and X360 = Low or

XHD = Low and X360 = X $T1(1.6M/2M) = 44RA + 62$ [ns]

The pulse width for 2nd monostable multivibrator is fixed at 400ns.

(2) Write system

Write data input through Pin 2 is frequency-divided by the T flip-flop and generates the recording current for the head. The recording current can be switched by the settings of Pins 9 and 18.

The write current Iw is set by the resistors Rw connected between Pin 25 and Vcc, between Pin 26 and Vcc, and between Pin 27 and Vcc.

$$I_w = 3.53/R_w \text{ [mA O-P]} \quad R_w \text{ [k}\Omega\text{]}$$

Furthermore, the inner/outer track write current Iw can be changed for each mode by switching Pin 4. However, the current ratio between the inner and outer tracks is fixed.

(3) Erase current

The erase current IE is set by the resistor RE between Pin 28 and Vcc.

$$I_E = 11.8/R_E \text{ [mA]} \quad R_E \text{ [k}\Omega\text{]}$$

Pins 30 and 31 are constant current outputs.

In addition, in order to minimize the R/W head crosstalk time constants are provided for the rise and fall of the erase current. For details, refer to page 20 and page 21.

(4) Power on/off detection system

The power on/off detection system detects a reduced voltage in the supply voltage.

When Vcc is below the specified value, the write system and erase system cease operation, disabling the write and erase functions.

Notes on Operation

- Select the voltage gain so that the preamplifier output amplitude is 1Vp-p or less.
If the preamplifier output amplitude exceeds 1Vp-p, the filter output waveform becomes distorted.
- Observe the following point when mounting this device.
 - The ground should be as large as possible.

Application Circuit

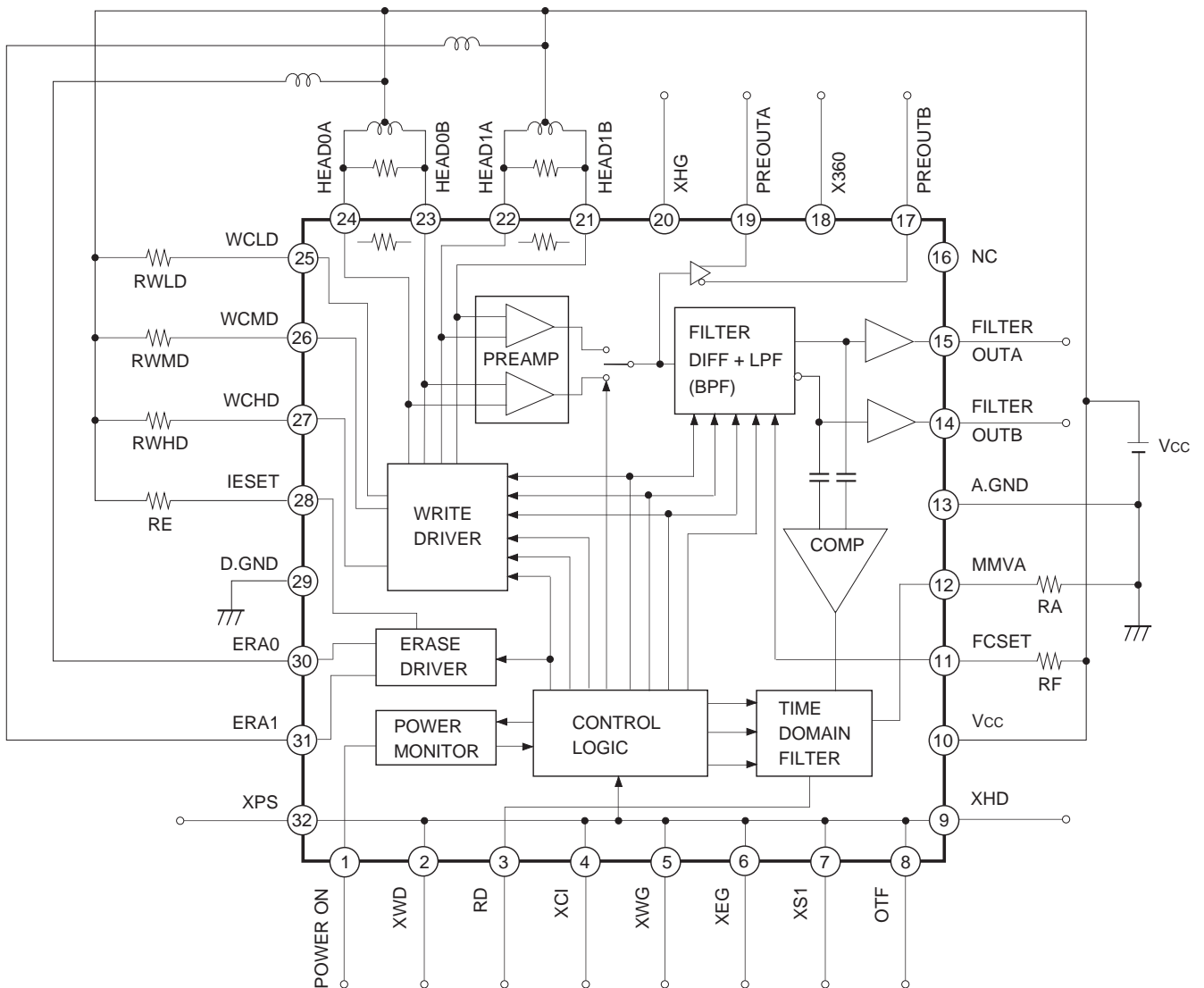

Application circuits shown are typical examples illustrating the operation of the devices. Sony cannot assume responsibility for any problems arising out of the use of these circuits or for any infringement of third party patent and other right due to same.

Notes

1. If a resistor for setting the write current is not used, connect that pin to Vcc. However, if connected to Vcc, do not select that mode for writes, as doing so could cause a large current flow that could damage the IC.
2. When using two modes (1M and 2M), connect X360 (Pin 18) to Vcc and set XHD (Pin 9) high or low to switch modes.

Filter Frequency Response

The LPF characteristics are set to Chebyshev (1dB ripple) for 1.6M, 2M/inner track mode only, and to Butterworth for the other modes. In addition, a custom selection can be made between Chebyshev (1dB ripple) and Butterworth for the filter characteristics for 1.6M, 2M/inner track mode only; in that case, it is not possible to change between 1.6M/inner track and 2M/inner track. As a result, the 1.6M and 2M characteristics and fc ratio are identical.

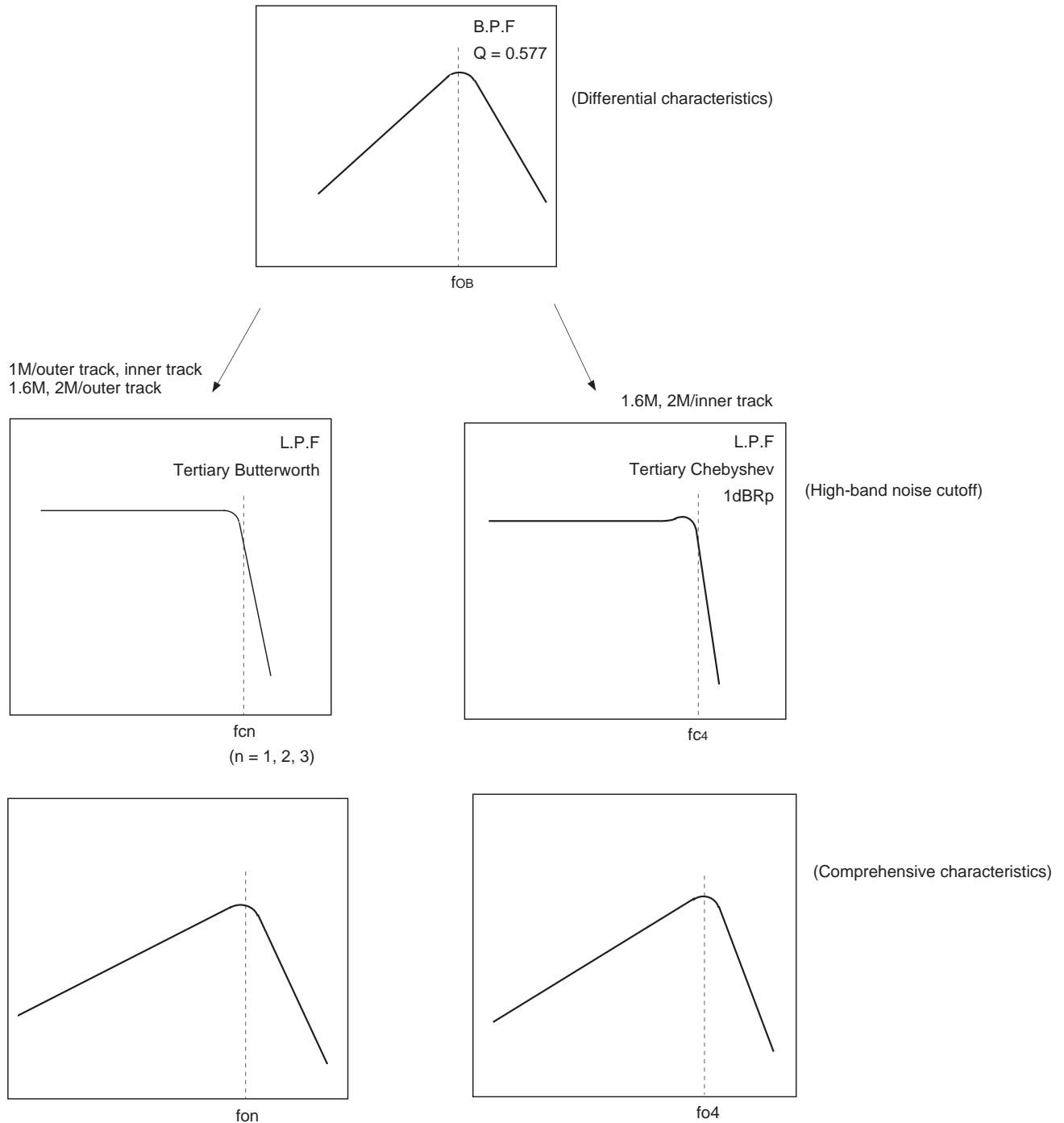

The BPF center frequency f_{oB} is fixed at 1.2 times the LPF cutoff frequency.

$$f_{oB} = 1.2f_c$$

In the comprehensive characteristics, the relationship between the peak frequencies f_o and f_c is as follows, depending on the differences of the LPF type:

- Butterworth characteristics $f_{cN} = 1.28f_{oN}$ ($n = 1, 2, 3$)
- Chebyshev (1dB ripple characteristics) $f_{c4} = 1.12f_{o4}$

Custom Selection of Filters

Regarding the LPF cutoff frequency f_0 , assuming the LPF cutoff frequency f_{c1} in 1M/outer track mode as 1.00, the f_c ratio can be selected for the other three modes.

In addition, the LPF characteristics are set to Chebyshev (1dB ripple) for 1.6M, 2M/inner track mode only, and to Butterworth for the other modes. However, a custom selection can be made between Chebyshev (1dB ripple) and Butterworth for the filter characteristics for 1.6M, 2M/inner track mode only. (However, the 1.6M and 2M characteristics and f_c ratio are identical.)

Note that the BPF center frequency f_{0B} is fixed at 1.2 times f_c . In addition, the ratio between f_0 and f_c conforms with the relationship shown on the previous page.

Mode	LPF type	f_c ratio when f_{c1} is assumed as 1
1M/outer track	Butterworth	1.0
1M/inner track	Butterworth	1.07 , 1.14 , 1.23 , 1.33 , 1.45 , 1.60 , 2.00
1.6M, 2M/outer track	Butterworth	1.33 , 1.39 , 1.45 , 1.52 , 1.60 , 1.68 , 1.78 , 1.88 , 2.00 , 2.13 , 2.29 , 2.46 , 2.67
1.6M, 2M/inner track	Butterworth Chebyshev (1dB ripple)	1.33 , 1.39 , 1.45 , 1.52 , 1.60 , 1.68 , 1.78 , 1.88 , 2.00 , 2.13 , 2.29 , 2.46 , 2.67

* The boxed ratio indicates the setting for the CXA3010Q.

Write Current Setting Method

Assuming the outer track as 1.00, the write current ratio is fixed within the IC for each mode. The write current for the outer track is set in each mode by the resistors connected to Pins 25, 26, and 27. The current ratio for the inner track in each mode can be selected according to the following table.

The setting is for the outer track current when XCI is Low, and for the inner track current when XCI is High.

Write current inner track setting ratios

Track	Write current inner track setting ratio
1M mode	1.00 , 0.92 , 0.86 , 0.80 , 0.75 , 0.71 , 0.66 , 0.63
1.6M mode	1.00 , 0.92 , 0.86 , 0.80 , 0.75 , 0.71 , 0.66 , 0.63
2M mode	1.00 , 0.92 , 0.86 , 0.80 , 0.75 , 0.71 , 0.66 , 0.63

* The boxed ratio indicates the setting for the CXA3010Q.

The write current setting for the outer track is determined according to the following formula:

$$I_W = 3.53/R_W \text{ (mA}_{O-P}) \quad R_W: [\text{k}\Omega]$$

Erase Current Setting Method

The erase circuit in this IC generates the erase current by using a constant current circuit; the current value is determined according to the following formula, based on the resistor R_E connected to Pin 28.

$$I_E = 11.8/R_E \text{ [mA]} \quad R_E: \text{ [k}\Omega\text{]}$$

Erase Current Rise and Fall Times (Refer to Fig. 3)

In this IC, time constants are provided for the erase current rise and fall in order to prevent bad writes due to write head crosstalk.

The current rise and fall times of the constant current circuit in the IC is $1.3\mu\text{s}$, but the potential difference V_A that develops in the head when the erase current is turned on and off is as shown below. Because the circuit clamp is generated according to this V_A value, the rise and fall times differ. Therefore, refer to the explanation provided below when using this IC.

$$V_A = L \times \frac{di}{dt} \quad (L: \text{ head inductance; } di: \text{ erase current; } dt: 1.3\mu\text{s})$$

1. When erase current turns on

(1) When the potential difference V_A in the head is $(V_{CC} - 1.8\text{V})$ or more

When the current turns on, potential difference V_A is generated in the head; if V_A is equal to $(V_{CC} - 1.8\text{V})$ or more, the erase output transistor Q1 shown in the circuit in Fig. 3 becomes saturated, and the pin voltage is clamped at approximately 1.8V. Voltage driving results, and the rise time T_r is as follows:

$$T_r = \frac{L \times I_E}{V_{CC} - 1.8} \times \frac{1}{1000} \text{ [\mu s]} \quad L: \text{ [\mu H]}, I_E: \text{ [mA]}, V_{CC}: \text{ [V]}$$

(2) When the potential difference V_A in the head is $(V_{CC} - 1.8\text{V})$ or less

In this case, because V_A does not reach clamping level, the rise time becomes the rise time of I_E in the circuits within the IC.

Current rise time $T_r = 1.3\mu\text{s}$

2. When erase current turns off

(1) When the potential difference V_A in the head is 0.7V or more

When the current turns off, potential difference V_A is generated in the head by counterelectromotive force; if V_A is equal to approximately 0.7V or more, the positive protective diode D1 shown in the circuit in Fig. 3 turns on, and the pin voltage is clamped at approximately $(V_{CC} + 0.7V)$. As when the erase current is turned on, voltage driving results, and the fall time T_f is as follows:

$$T_f = \frac{L \times I_E}{0.7} \times \frac{1}{1000} [\mu s] \quad L: [\mu H], I_E: [mA]$$

(2) When the potential difference V_A in the head is 0.7V or less

In this case, because V_A does not reach clamping level, the fall time becomes the fall time of I_E in the circuits within the IC.

Current fall time $T_f = 1.3\mu s$

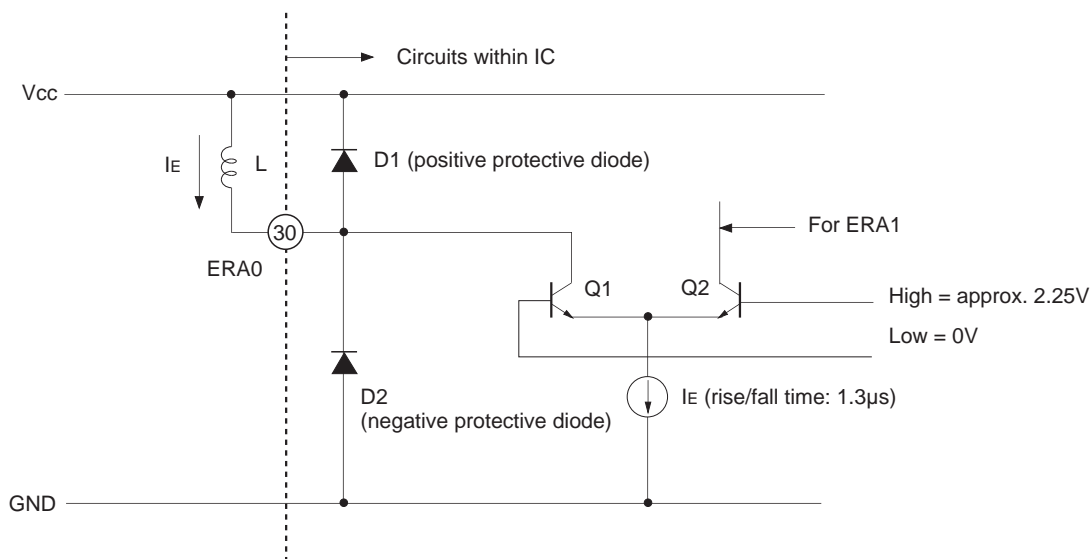
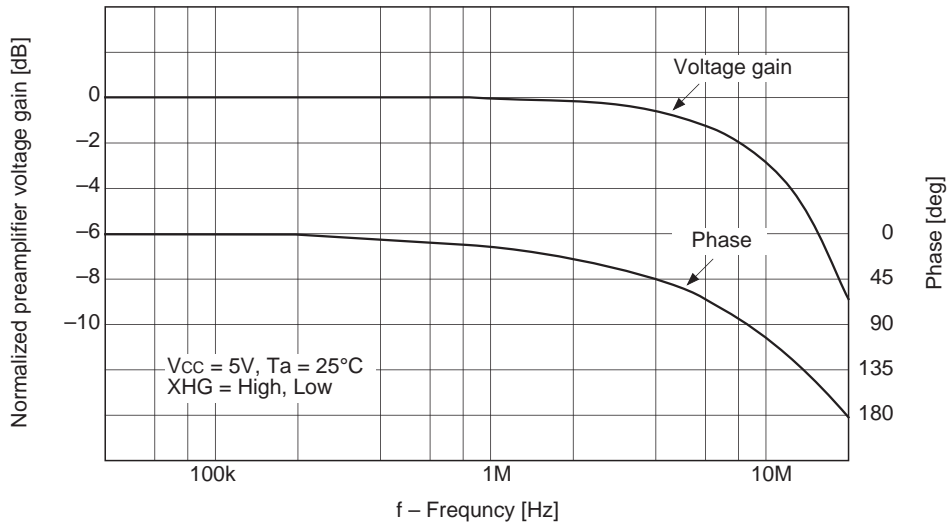

Fig. 3. Erase equivalent circuit

However, in the specifications, because the value indicated is with the erase head pin shorted with the power supply so that the head voltage described earlier is not generated, the rise and fall times for the constant current circuit itself are given.

Normalized preamplifier voltage gain and phase vs. Frequency



1M/outer track

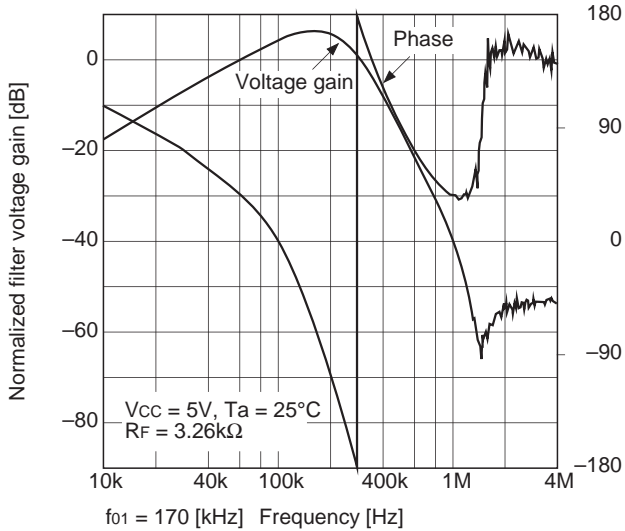

1M/inner track

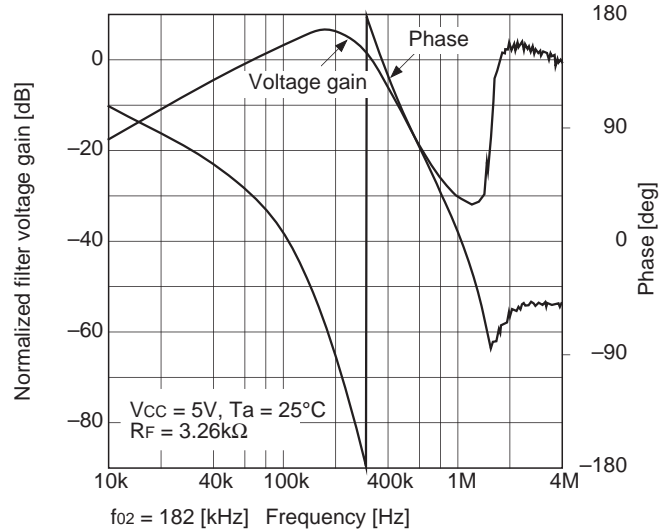

1.6M, 2M/outer track

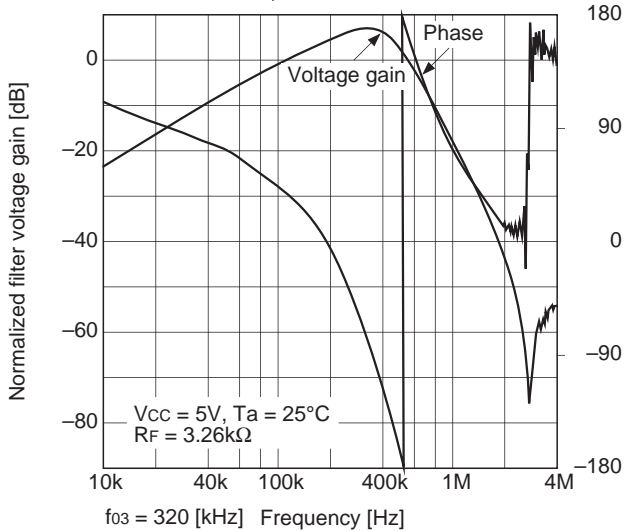

1.6M, 2M/inner track

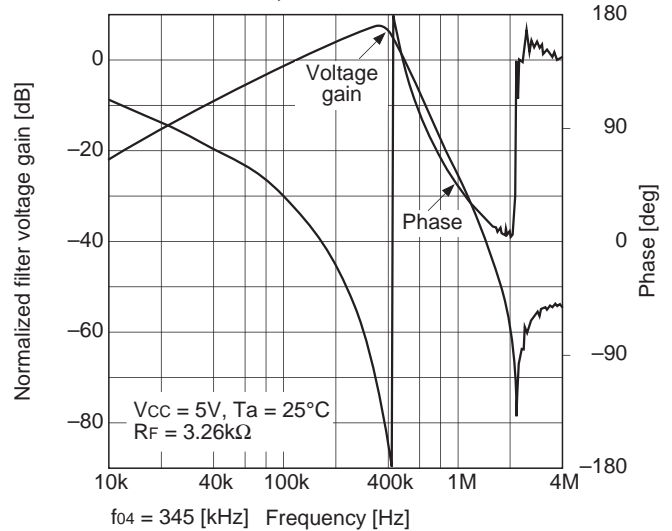

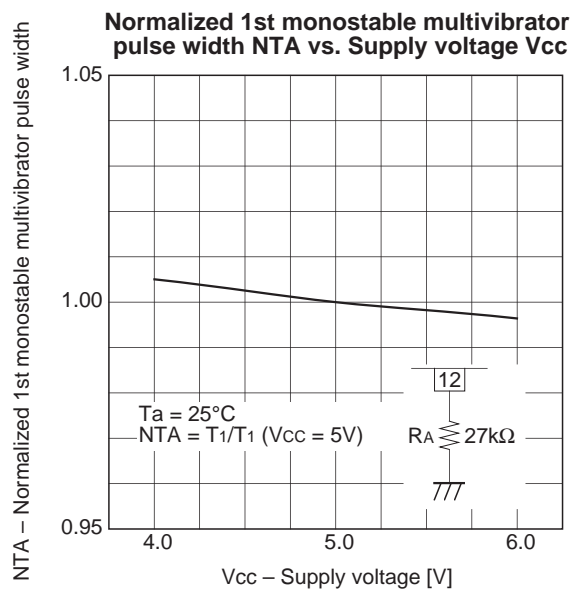
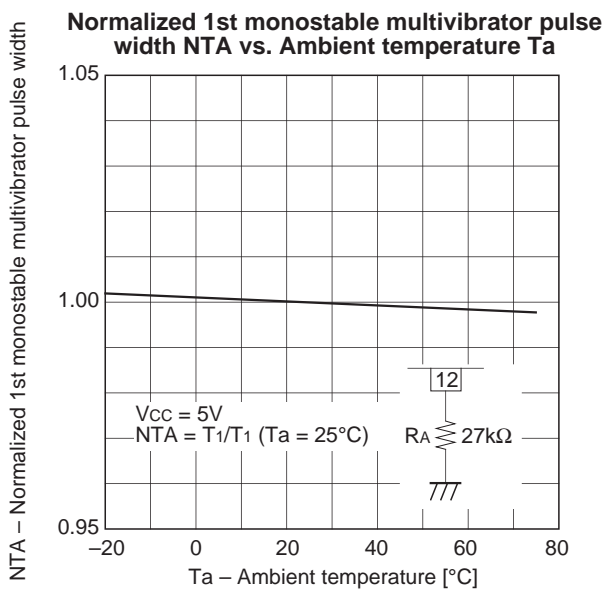
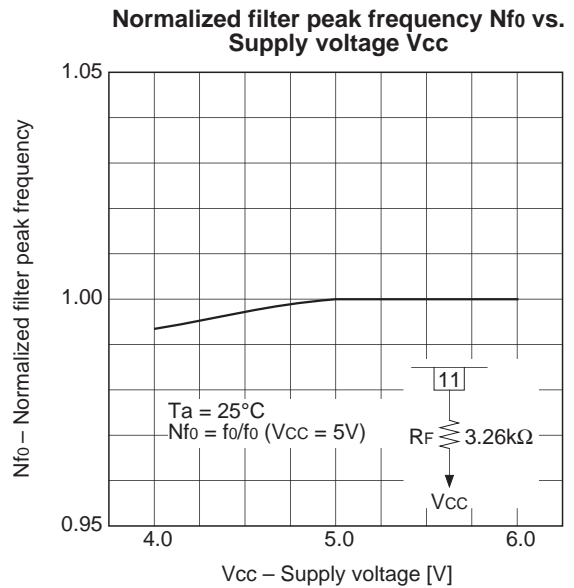
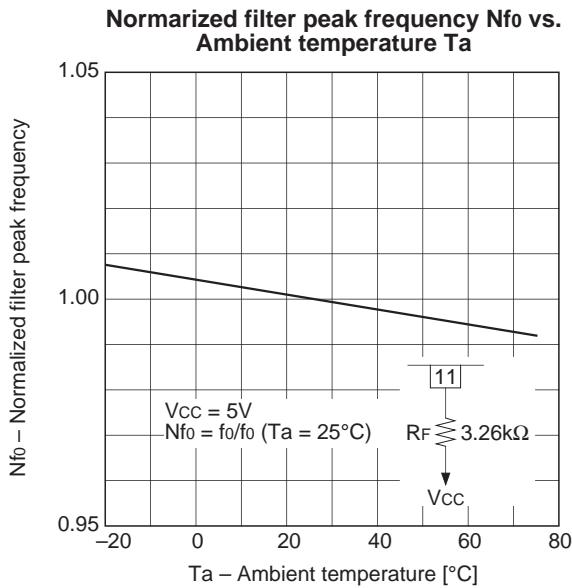
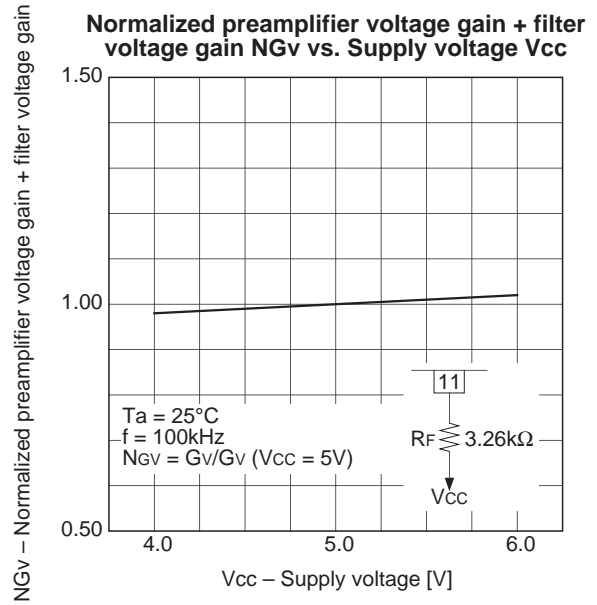
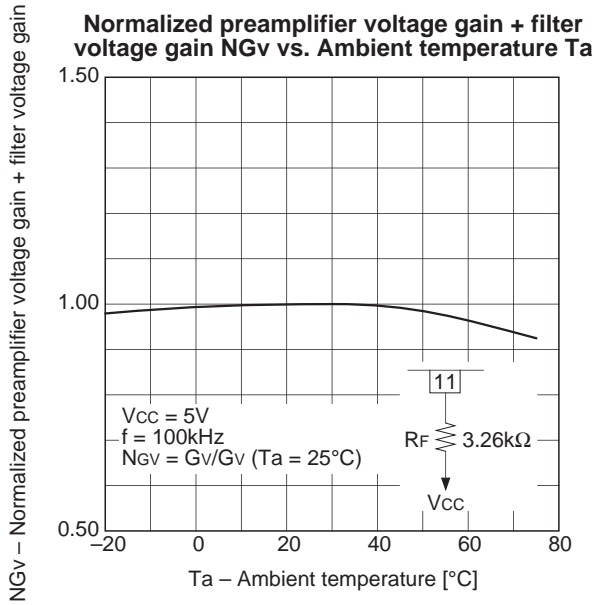

Normalized read data pulse width NTB vs. Ambient temperature Ta

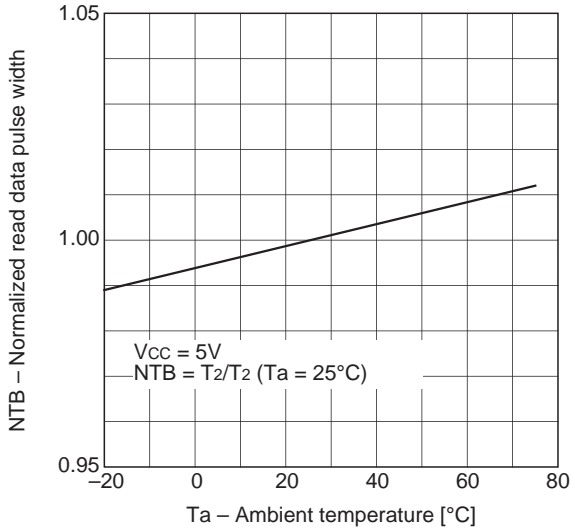

Normalized read data pulse width NTB vs. Supply voltage Vcc

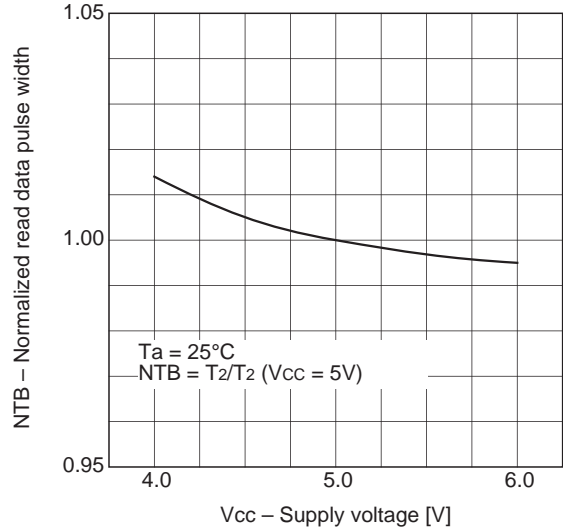

Normalized write current NIw vs. Ambient temperature Ta

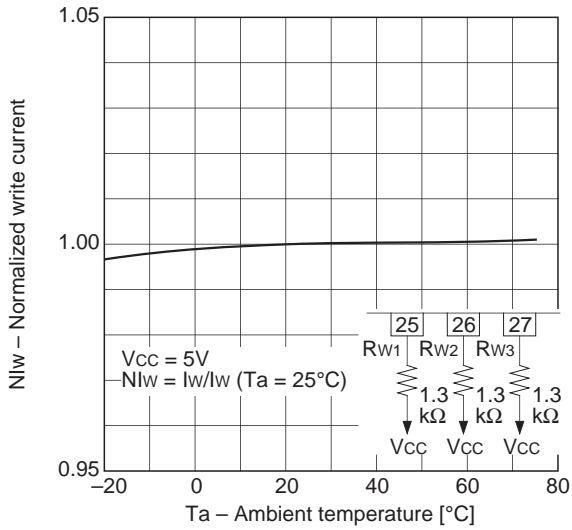

Normalized write current NIw vs. Supply voltage Vcc

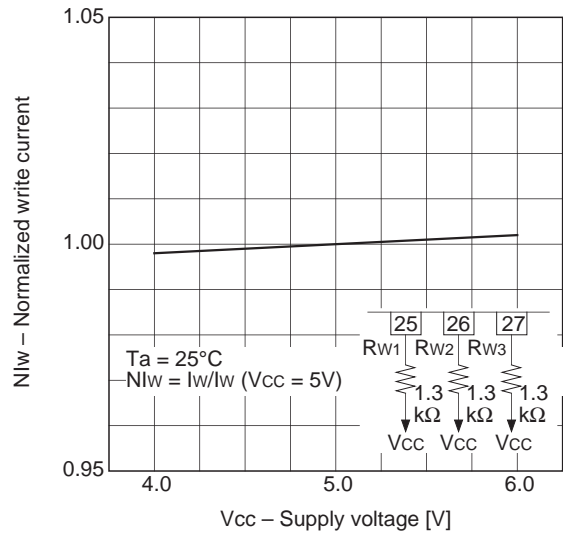

Normalized erase current NIE vs. Ambient temperature Ta

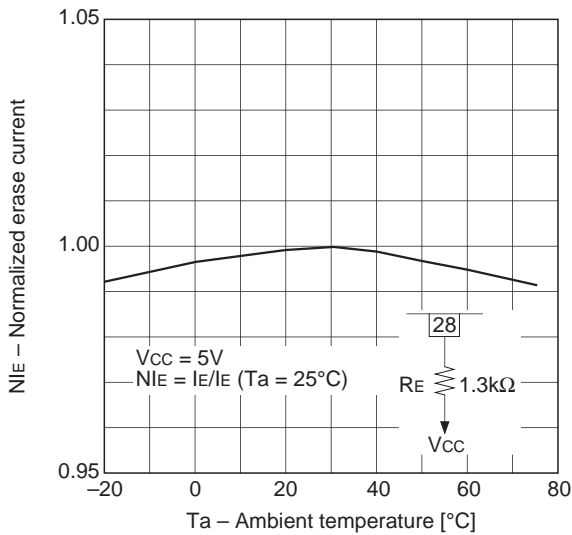

Normalized erase current NIE vs. Supply voltage Vcc

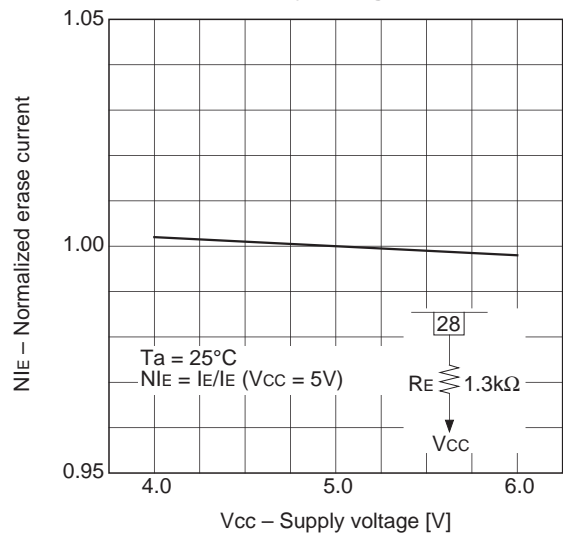

1M/outer track peak frequency f_{01} vs. R_F

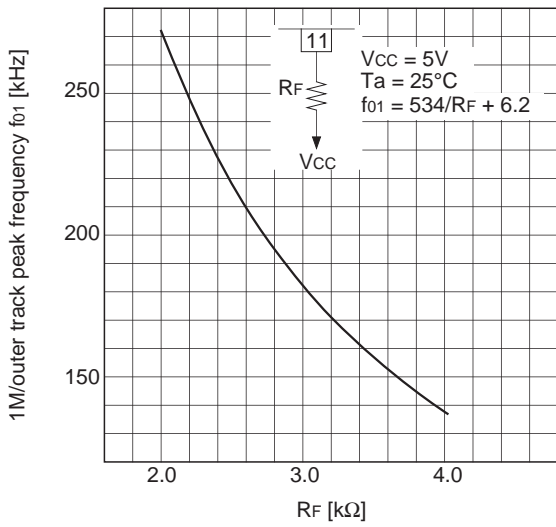

1st monostable multivibrator pulse width T_A vs. R_A

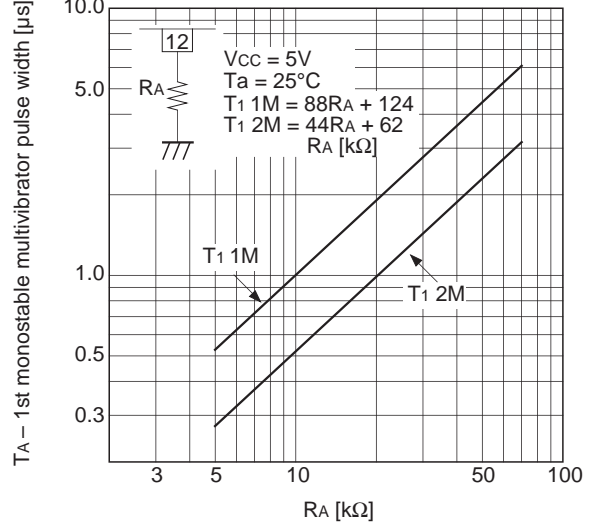

Write current I_W vs. R_W

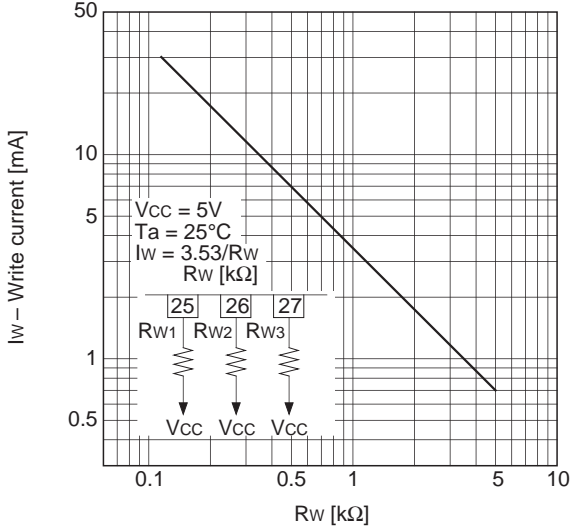

Erase current I_E vs. R_E

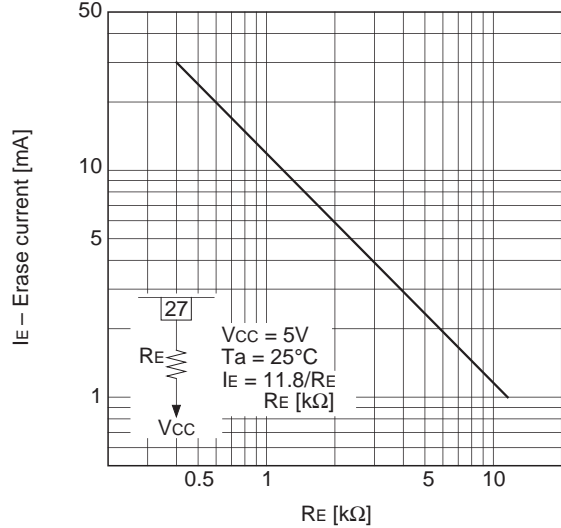

Power supply on/off detector threshold voltage V_{TH} vs. Ambient temperature T_a

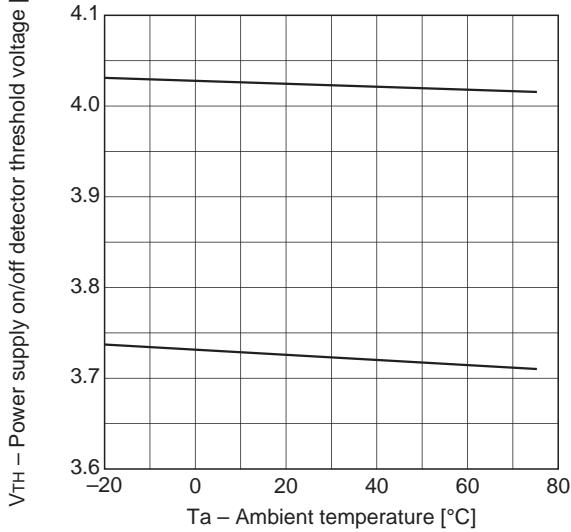

Package Outline

Unit: mm

32PIN QFP (PLASTIC)

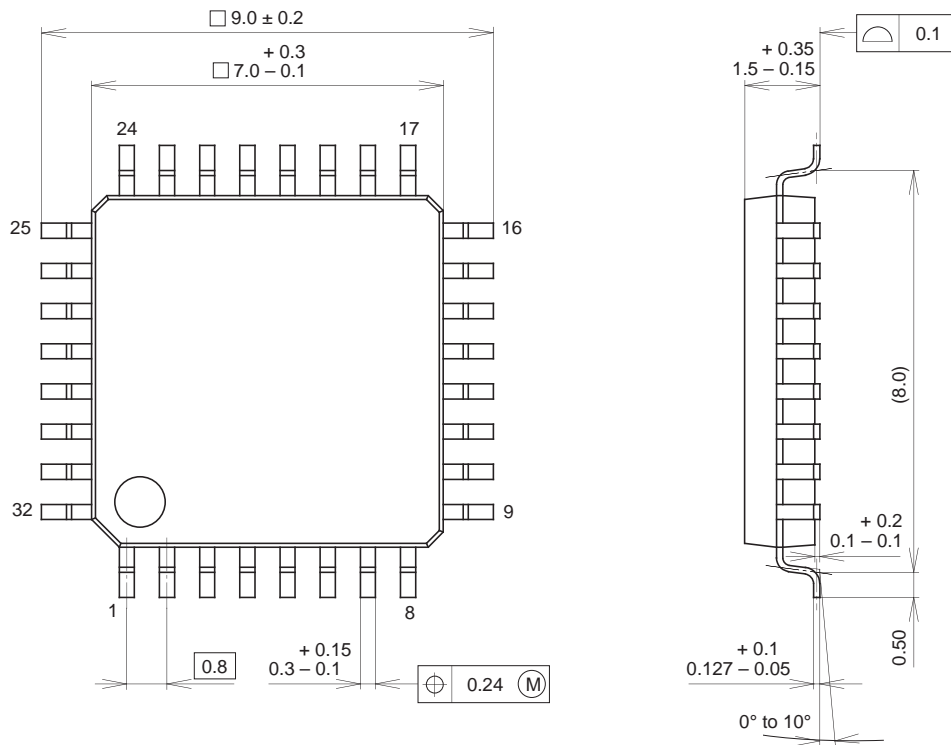

SONY CODE	QFP-32P-L01
EIAJ CODE	QFP032-P-0707
JEDEC CODE	_____

PACKAGE MATERIAL	EPOXY RESIN
LEAD TREATMENT	SOLDER PLATING
LEAD MATERIAL	42 ALLOY
PACKAGE MASS	0.2g