

**Damper diode  
fast, high-voltage**

**BY329X-1500, BY329X-1500S**

**FEATURES**

- Low forward volt drop
- Fast switching
- Soft recovery characteristic
- High thermal cycling performance
- Isolated mounting tab

**SYMBOL**

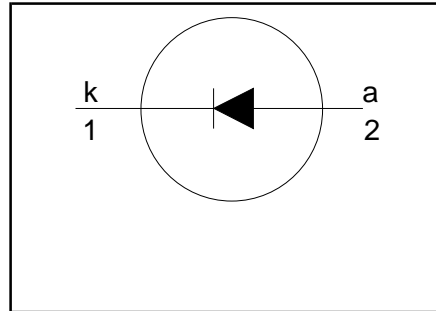

**QUICK REFERENCE DATA**

$V_R = 1500\text{ V}$
$V_F \leq 1.35\text{ V} / 1.5\text{ V}$
$I_{F(\text{peak})} = 6\text{ A}$ (f = 16 kHz)
$I_{F(\text{peak})} = 6\text{ A}$ (f = 70 kHz)
$I_{FSM} \leq 75\text{ A}$
$t_{tr} \leq 230\text{ ns} / 160\text{ ns}$

**GENERAL DESCRIPTION**

Glass-passivated double diffused rectifier diode featuring low forward voltage drop, fast reverse recovery and soft recovery characteristic. The device is intended for use in TV receivers and PC monitors.

The BY329X series is supplied in the conventional leaded SOD113 package.

**PINNING**

PIN	DESCRIPTION
1	anode
2	cathode
tab	isolated

**SOD113**

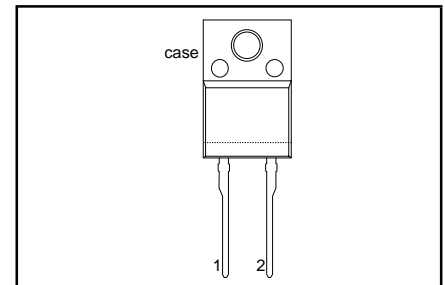

**LIMITING VALUES**

Limiting values in accordance with the Absolute Maximum System (IEC 134).

SYMBOL	PARAMETER	CONDITIONS	MIN.	MAX.	UNIT
$V_{RSM}$	Peak non-repetitive reverse voltage		-	1500	V
$V_{RRM}$	Peak repetitive reverse voltage		-	1500	V
$V_{RWM}$	Crest working reverse voltage		-	1300	V
$I_{F(\text{peak})}$	Peak working forward current	f = 16 kHz	-	<b>-1500</b>	A
		f = 70 kHz	-	<b>-1500S</b>	
$I_{FRM}$	Peak repetitive forward current	t = 25 $\mu$ s; $\delta$ = 0.5; $T_{hs} \leq 86\text{ }^\circ\text{C}$	-	14	A
$I_{F(\text{RMS})}$	RMS forward current		-	11	A
$I_{FSM}$	Peak non-repetitive forward current	t = 10 ms sinusoidal; $T_j = 150\text{ }^\circ\text{C}$ prior to surge; with reapplied $V_{RWM(\text{max})}$	-	75	A
$T_{stg}$	Storage temperature		-40	150	$^\circ\text{C}$
$T_j$	Operating junction temperature		-	150	$^\circ\text{C}$

## Damper diode fast, high-voltage

BY329X-1500, BY329X-1500S

### ISOLATION LIMITING VALUE & CHARACTERISTIC

 $T_{hs} = 25\text{ }^{\circ}\text{C}$  unless otherwise specified

SYMBOL	PARAMETER	CONDITIONS	MIN.	TYP.	MAX.	UNIT
$V_{isol}$	R.M.S. isolation voltage from both terminals to external heatsink	$f = 50\text{-}60\text{ Hz}$ ; sinusoidal waveform; $R.H. \leq 65\%$ ; clean and dustfree	-		2500	V
$C_{isol}$	Capacitance from both terminals to external heatsink	$f = 1\text{ MHz}$	-	10	-	pF

### THERMAL RESISTANCES

SYMBOL	PARAMETER	CONDITIONS	MIN.	TYP.	MAX.	UNIT
$R_{th\ j\text{-}hs}$	Thermal resistance junction to heatsink	with heatsink compound	-	-	4.8	K/W
$R_{th\ j\text{-}a}$	Thermal resistance junction to ambient	without heatsink compound in free air.	-	55	5.9	K/W

### STATIC CHARACTERISTICS

 $T_j = 25\text{ }^{\circ}\text{C}$  unless otherwise stated

SYMBOL	PARAMETER	CONDITIONS	TYP.		MAX.		UNIT
			1500	1500S	1500	1500S	
$V_F$	Forward voltage	<b>BY329X-</b> $I_F = 6.5\text{ A}$	1.1	1.3	1.45	1.6	V
$I_R$	Reverse current	$I_F = 6.5\text{ A}$ ; $T_j = 125\text{ }^{\circ}\text{C}$ $V_R = 1300\text{ V}$ $V_R = 1300\text{ V}$ ; $T_j = 125\text{ }^{\circ}\text{C}$	1.05	1.2	1.35	1.5	V
			-	250	-	250	$\mu\text{A}$
			-	1	-	1	mA

### DYNAMIC CHARACTERISTICS

 $T_j = 25\text{ }^{\circ}\text{C}$  unless otherwise stated

SYMBOL	PARAMETER	CONDITIONS	TYP.		MAX.		UNIT
			1500	1500S	1500	1500S	
$t_{rr}$	Reverse recovery time	<b>BY329X</b> $I_F = 1\text{ A}$ ; $V_R \geq 30\text{ V}$ ; $di_F/dt = 50\text{ A}/\mu\text{s}$	0.18	0.13	0.23	0.16	$\mu\text{s}$
$Q_s$	Reverse recovery charge	$I_F = 2\text{ A}$ ; $-di_F/dt = 20\text{ A}/\mu\text{s}$	1.6	0.7	2.0	0.95	$\mu\text{C}$
$V_{fr}$	Peak forward recovery voltage	$I_F = 6.5\text{ A}$ ; $di_F/dt = 50\text{ A}/\mu\text{s}$	17	23	30	40	V
$t_{fr}$	Forward recovery time	$I_F = 6.5\text{ A}$ ; $di_F/dt = 50\text{ A}/\mu\text{s}$	210	220	300	320	ns

Damper diode  
fast, high-voltage

BY329X-1500, BY329X-1500S

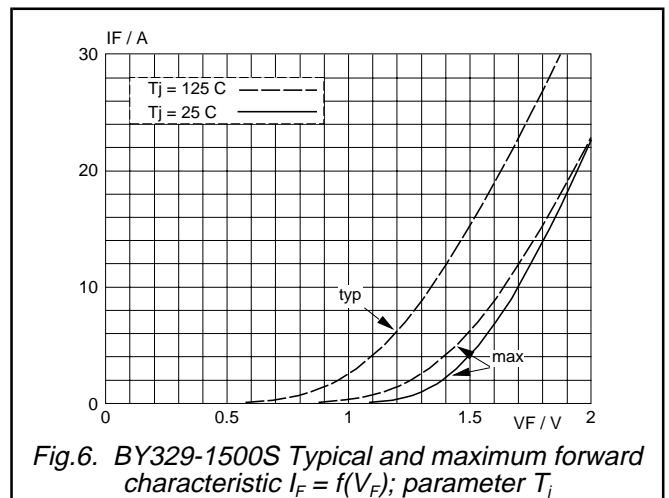
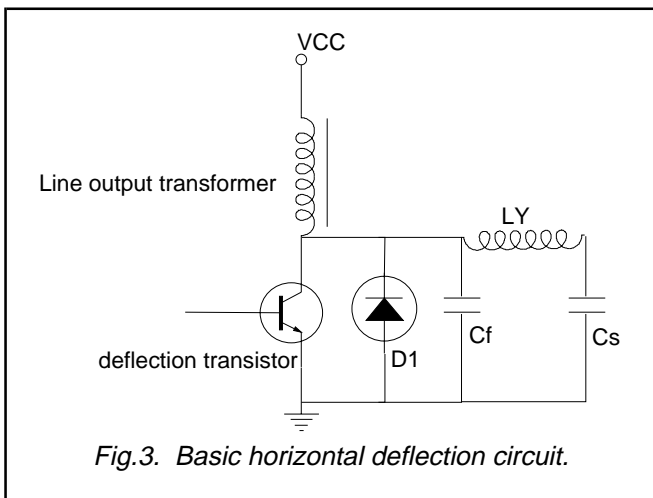
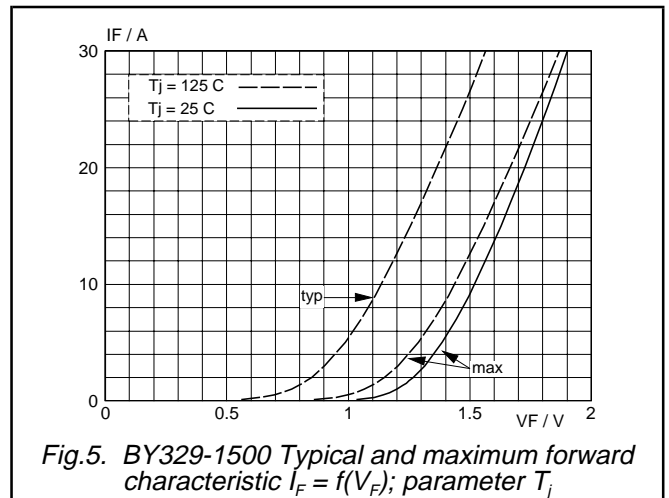
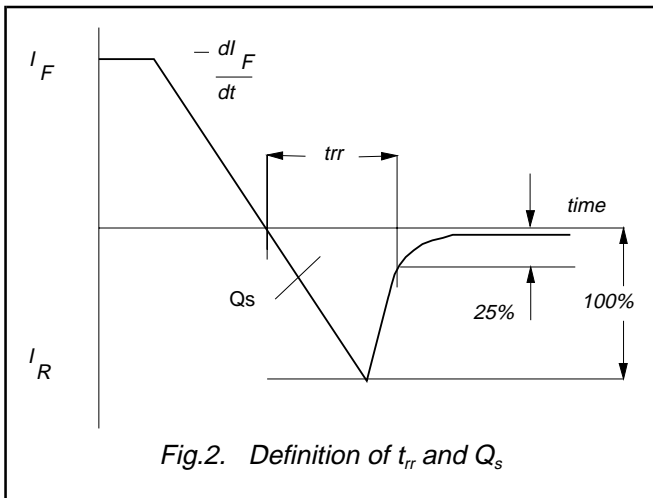
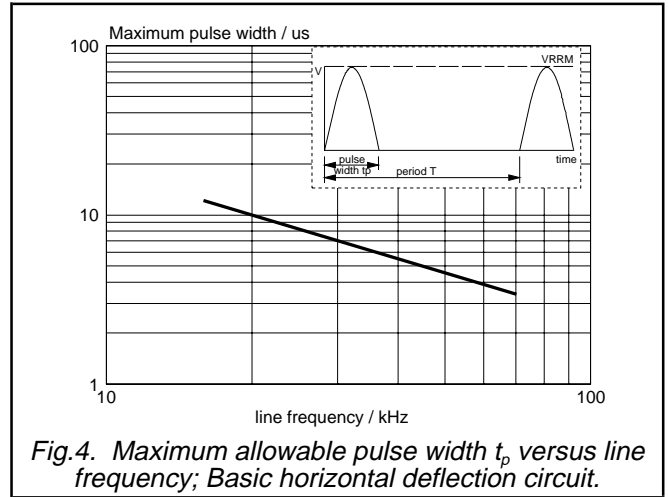
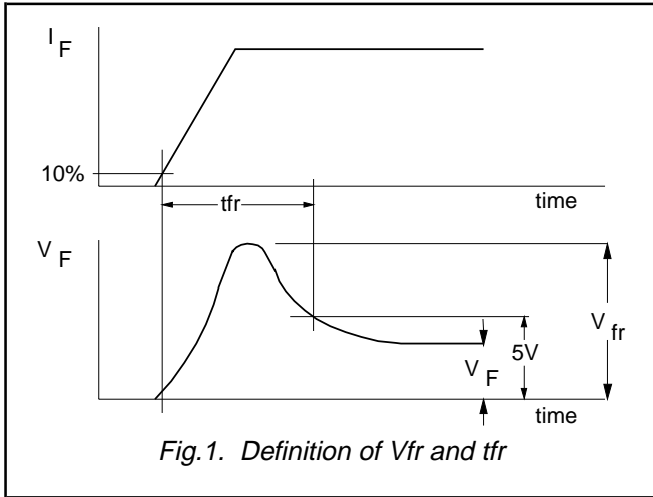

Damper diode  
fast, high-voltage

BY329X-1500, BY329X-1500S

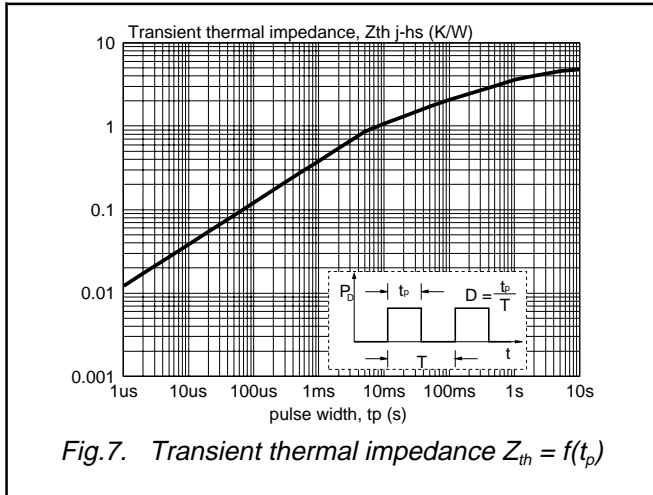
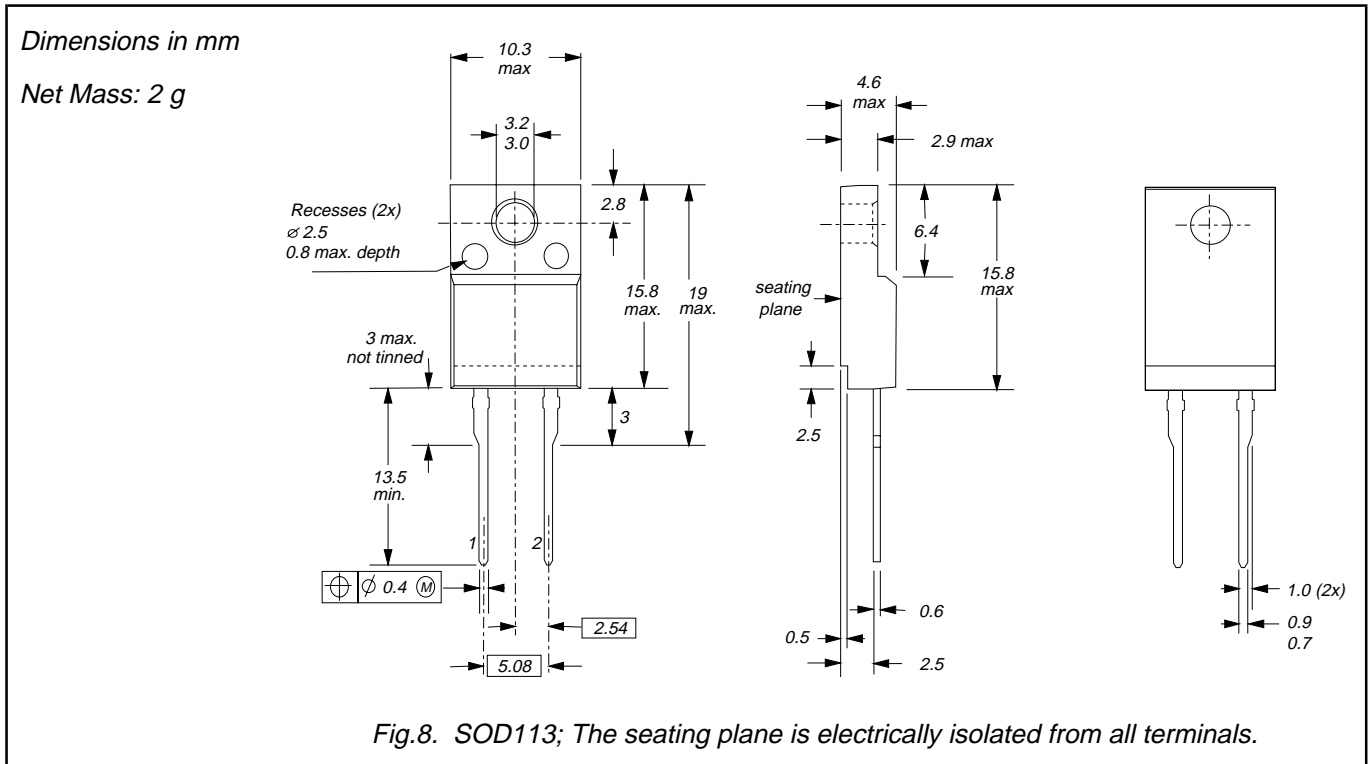

Fig.7. Transient thermal impedance  $Z_{th} = f(t_p)$

Damper diode  
fast, high-voltage

BY329X-1500, BY329X-1500S

**MECHANICAL DATA**



**Notes**

1. Refer to mounting instructions for F-pack envelopes.
2. Epoxy meets UL94 V0 at 1/8".

Damper diode  
fast, high-voltage

BY329X-1500, BY329X-1500S

## DEFINITIONS

<b>Data sheet status</b>	
Objective specification	This data sheet contains target or goal specifications for product development.
Preliminary specification	This data sheet contains preliminary data; supplementary data may be published later.
Product specification	This data sheet contains final product specifications.
<b>Limiting values</b>	
Limiting values are given in accordance with the Absolute Maximum Rating System (IEC 134). Stress above one or more of the limiting values may cause permanent damage to the device. These are stress ratings only and operation of the device at these or at any other conditions above those given in the Characteristics sections of this specification is not implied. Exposure to limiting values for extended periods may affect device reliability.	
<b>Application information</b>	
Where application information is given, it is advisory and does not form part of the specification.	
© Philips Electronics N.V. 1998	
All rights are reserved. Reproduction in whole or in part is prohibited without the prior written consent of the copyright owner.	
The information presented in this document does not form part of any quotation or contract, it is believed to be accurate and reliable and may be changed without notice. No liability will be accepted by the publisher for any consequence of its use. Publication thereof does not convey nor imply any license under patent or other industrial or intellectual property rights.	

## LIFE SUPPORT APPLICATIONS

These products are not designed for use in life support appliances, devices or systems where malfunction of these products can be reasonably expected to result in personal injury. Philips customers using or selling these products for use in such applications do so at their own risk and agree to fully indemnify Philips for any damages resulting from such improper use or sale.