

## PLASTIC MEDIUM-POWER COMPLEMENTARY SILICON TRANSISTORS

...designed for general-purpose amplifier and low speed switching applications

### FEATURES:

\* Collector-Emitter Sustaining Voltage-

$$V_{CE(SUS)} = 60 \text{ V (Min) - TIP130, TIP135}$$

$$= 80 \text{ V (Min) - TIP131, TIP136}$$

$$= 100 \text{ V (Min) - TIP132, TIP137}$$

\* Collector-Emitter Saturation Voltage

$$V_{CE(sat)} = 2.0 \text{ V (Max.) @ } I_C = 4.0 \text{ A}$$

\* Monolithic Construction with Built-in Base-Emitter Shunt Resistor

<b>NPN</b>	<b>PNP</b>
<b>TIP130</b>	<b>TIP135</b>
<b>TIP131</b>	<b>TIP136</b>
<b>TIP132</b>	<b>TIP137</b>

**8.0 AMPERE  
DARLINGTON  
COMPLEMENTARY SILICON  
POWER TRANSISTORS  
60-100 VOLTS  
70 WATTS**

### MAXIMUM RATINGS

Characteristic	Symbol	TIP130 TIP135	TIP131 TIP136	TIP132 TIP137	Unit
Collector-Emitter Voltage	$V_{CEO}$	60	80	100	V
Collector-Base Voltage	$V_{CBO}$	60	80	100	V
Emitter-Base Voltage	$V_{EBO}$	5.0			V
Collector Current-Continuous -Peak	$I_C$ $I_{CM}$	8.0 12			A
Base Current	$I_B$	0.3			mA
Total Power Dissipation @ $T_C = 25^\circ\text{C}$ Derate above $25^\circ\text{C}$	$P_D$	70 0.56			W W/ $^\circ\text{C}$
Operating and Storage Junction Temperature Range	$T_J, T_{STG}$	- 65 to +150			$^\circ\text{C}$

### THERMAL CHARACTERISTICS

Characteristic	Symbol	Max	Unit
Thermal Resistance Junction to Case	$R_{\theta jc}$	1.785	$^\circ\text{C/W}$

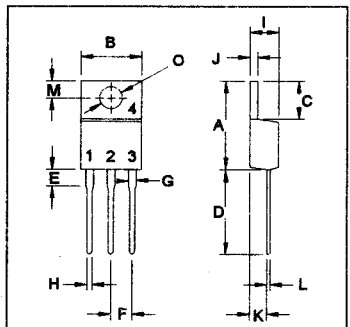
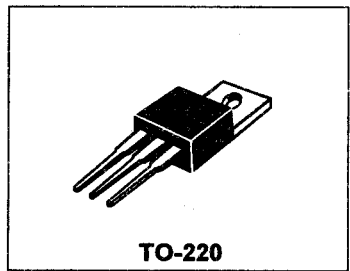
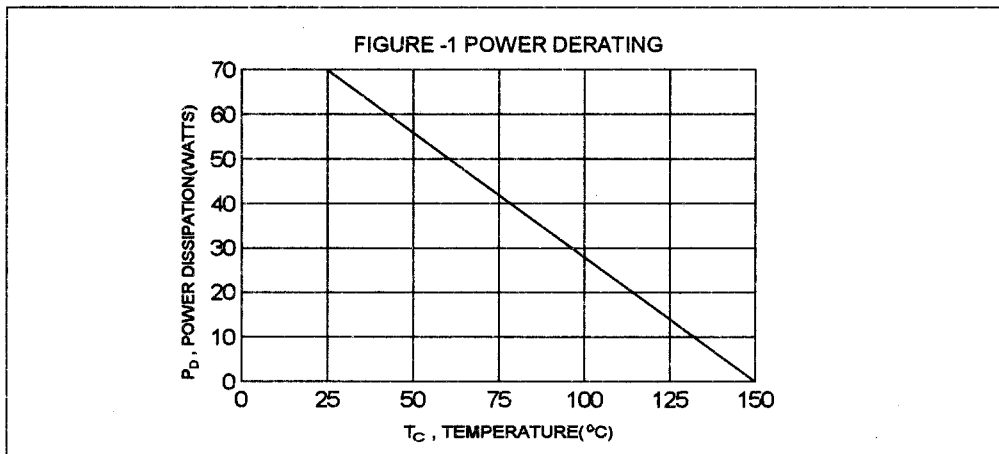

DIM	MILLIMETERS	
	MIN	MAX
A	14.68	15.31
B	9.78	10.42
C	5.01	6.52
D	13.06	14.62
E	3.57	4.07
F	2.42	3.66
G	1.12	1.36
H	0.72	0.96
I	4.22	4.98
J	1.14	1.38
K	2.20	2.97
L	0.33	0.55
M	2.48	2.98
O	3.70	3.90

TIP130, TIP131, TIP132 NPN / TIP135, TIP136, TIP137 PNP

**ELECTRICAL CHARACTERISTICS** (  $T_c = 25^\circ\text{C}$  unless otherwise noted )

Characteristic	Symbol	Min	Max	Unit
----------------	--------	-----	-----	------

**OFF CHARACTERISTICS**

Collector - Emitter Sustaining Voltage (1) ( $I_C = 30\text{ mA}$ , $I_B = 0$ )	TIP130, TIP135 TIP131, TIP136 TIP132, TIP137	$V_{CEO(sus)}$	60 80 100	V
Collector Cutoff Current ( $V_{CE} = 30\text{ V}$ , $I_B = 0$ ) ( $V_{CE} = 40\text{ V}$ , $I_B = 0$ ) ( $V_{CE} = 50\text{ V}$ , $I_B = 0$ )	TIP130, TIP135 TIP131, TIP136 TIP132, TIP137	$I_{CEO}$	0.5 0.5 0.5	mA
Collector Cutoff Current ( $V_{CB} = 60\text{ V}$ , $I_E = 0$ ) ( $V_{CB} = 80\text{ V}$ , $I_E = 0$ ) ( $V_{CB} = 100\text{ V}$ , $I_E = 0$ )	TIP130, TIP135 TIP131, TIP136 TIP132, TIP137	$I_{CBO}$	0.2 0.2 0.2	mA
Emitter Cutoff Current ( $V_{EB} = 5.0\text{ V}$ , $I_C = 0$ )		$I_{EBO}$	5.0	mA

**ON CHARACTERISTICS (1)**

DC Current Gain ( $I_C = 1.0\text{ A}$ , $V_{CE} = 4.0\text{ V}$ ) ( $I_C = 4.0\text{ A}$ , $V_{CE} = 4.0\text{ V}$ )		$h_{FE}$	500 1000	15000	
Collector-Emitter Saturation Voltage ( $I_C = 4.0\text{ A}$ , $I_B = 16\text{ mA}$ ) ( $I_C = 6.0\text{ A}$ , $I_B = 30\text{ mA}$ )		$V_{CE(sat)}$		2.0 3.0	V
Base-Emitter On Voltage ( $I_C = 4.0\text{ A}$ , $V_{CE} = 4.0\text{ V}$ )		$V_{BE(on)}$		2.5	V

**DYNAMIC CHARACTERISTICS**

Output Capacitance ( $V_{CB} = 10\text{ V}$ , $I_E = 0$ , $f = 0.1\text{ MHz}$ )		$C_{ob}$		250	pF
---	--	----------	--	-----	----

(1) Pulse Test: Pulse width =  $300\ \mu\text{s}$ , Duty Cycle  $\leq 2.0\%$

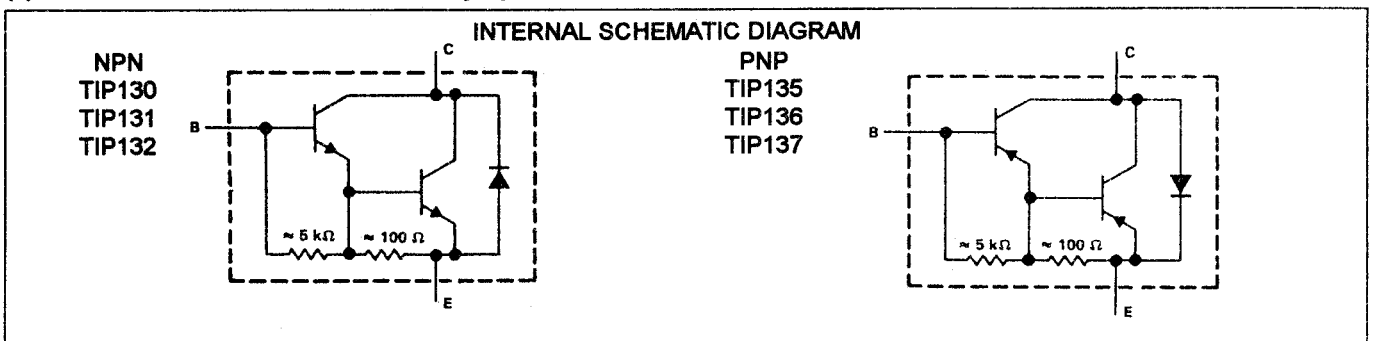

FIG-2 DC CURRENT GAIN

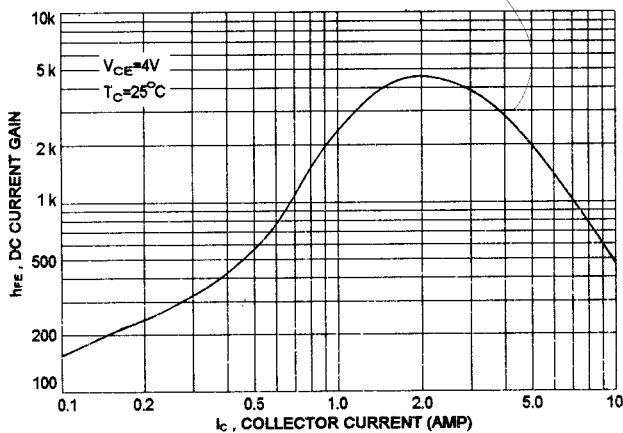

FIG-3 BASE-EMITTER VOLTAGE

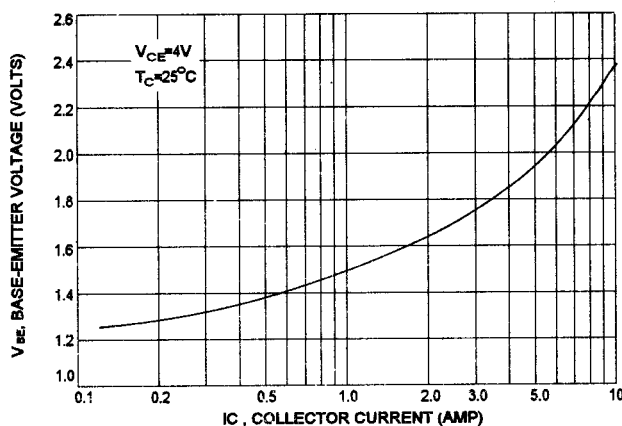

FIG-4 COLLECTOR-EMITTER SATURATION VOLTAGE

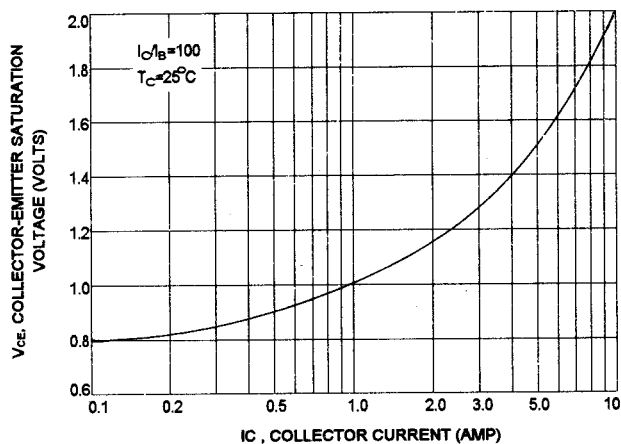

FIG-5 FORWARD VOLTAGE COMMUTATING DIODE

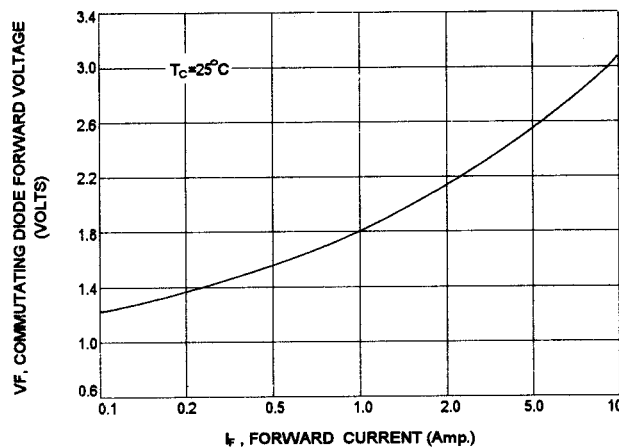
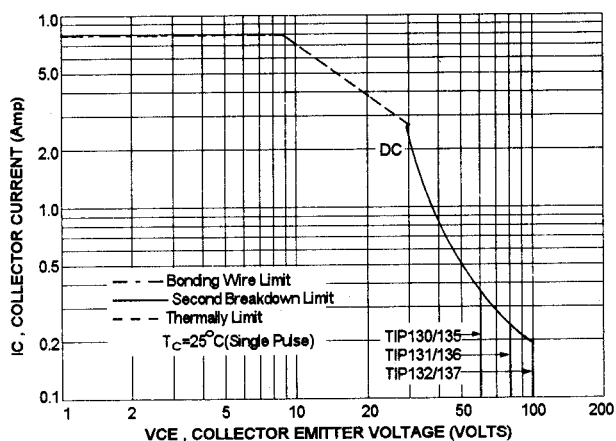

FIG-6 ACTIVE REGION SAFE OPERATING AREA



There are two limitation on the power handling ability of a transistor: average junction temperature and second breakdown safe operating area curves indicate  $I_C$ - $V_{CE}$  limits of the transistor that must be observed for reliable operation i.e., the transistor must not be subjected to greater dissipation than curves indicate.

The data of FIG-6 curve is base on  $T_{J(PK)}=150^\circ\text{C}$ ;  $T_C$  is variable depending on power level. second breakdown pulse limits are valid for duty cycles to 10% provided  $T_{J(PK)} \leq 150^\circ\text{C}$ . At high case temperatures, thermal limitation will reduce the power that can be handled to values less than the limitations imposed by second breakdown.