

## The RF Sub-Micron Bipolar Line RF Power Bipolar Transistors

Designed for broadband commercial and industrial applications at frequencies from 1400 to 1600 MHz. The high gain and broadband performance of these devices makes them ideal for large-signal, common-emitter class A and class AB amplifier applications in 26 volt amplitude modulated and multi-carrier base station equipment.

- Guaranteed Two-Tone Performance at 1490 MHz, 26 Volts  
Output Power — 60 Watts (PEP)  
Power Gain — 10 dB  
Efficiency — 33%
- Characterized with Series Equivalent Large-Signal Impedance Parameters
- S-Parameter Characterization at High Bias Levels
- Excellent Thermal Stability
- All Gold Metal for Ultra Reliability
- Capable of Handling 3:1 VSWR @ 26 Vdc, 1490 MHz, 60 Watts (PEP)  
Output Power

**MRF15060**  
**MRF15060S**

**60 W, 1.49 GHz**  
**RF POWER**  
**BIPOLAR**  
**TRANSISTORS**

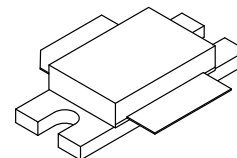

**CASE 451-04, STYLE 1**  
**(MRF15060)**

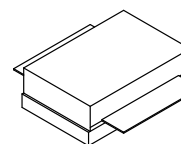

**CASE 451A-01, STYLE 1**  
**(MRF15060S)**

### MAXIMUM RATINGS

Rating	Symbol	Value	Unit
Collector-Emitter Voltage	$V_{CEO}$	25	Vdc
Collector-Emitter Voltage	$V_{CES}$	60	Vdc
Emitter-Base Voltage	$V_{EBO}$	60	Adc
Collector Current – Continuous	$I_C$	8	Adc
Total Device Dissipation @ $T_C = 70^\circ\text{C}$ Derate above $70^\circ\text{C}$	$P_D$	185 1.43	Watts W/ $^\circ\text{C}$
Storage Temperature Range	$T_{stg}$	- 65 to +150	$^\circ\text{C}$
Operating Junction Temperature	$T_J$	200	$^\circ\text{C}$

### THERMAL CHARACTERISTICS

Rating	Symbol	Max	Unit
Thermal Resistance, Junction to Case	$R_{\theta JC}$	0.7	$^\circ\text{C}/\text{W}$

**ELECTRICAL CHARACTERISTICS** ( $T_C = 25^\circ\text{C}$  unless otherwise noted)

Characteristic	Symbol	Min	Typ	Max	Unit
----------------	--------	-----	-----	-----	------

**OFF CHARACTERISTICS**

Collector–Emitter Breakdown Voltage ( $I_C = 50\text{ mA}$ , $I_B = 0$ )	$V_{(BR)CEO}$	25	—	—	Vdc
Collector–Emitter Breakdown Voltage ( $I_C = 50\text{ mA}$ , $V_{BE} = 0$ )	$V_{(BR)CES}$	60	—	—	Vdc
Emitter–Base Breakdown Voltage ( $I_E = 10\text{ mA}$ , $I_C = 0\text{ mA}$ )	$V_{(BR)EBO}$	3	3.5	—	Vdc
Collector Cutoff Current ( $V_{CE} = 30\text{ Vdc}$ , $V_{BE} = 0$ )	$I_{CES}$	—	—	10	mAdc

**ON CHARACTERISTICS**

DC Current Gain ( $I_C = 1\text{ Adc}$ , $V_{CE} = 5\text{ Vdc}$ )	$h_{FE}$	20	40	80	—
---	----------	----	----	----	---

**DYNAMIC CHARACTERISTICS**

Output Capacitance ( $V_{CB} = 26\text{ Vdc}$ , $I_E = 0$ , $f = 1.0\text{ MHz}$ ) (1)	$C_{ob}$	—	55	—	pF
---	----------	---	----	---	----

**FUNCTIONAL TESTS** (In Motorola Test Circuit. See Figure 1)

Common–Emitter Amplifier Power Gain ( $V_{CC} = 26\text{ Vdc}$ , $P_{out} = 60\text{ Watts (PEP)}$ , $I_{CQ} = 200\text{ mA}$ , $f_1 = 1490.0\text{ MHz}$ , $f_2 = 1490.1\text{ MHz}$ )	$G_{pe}$	10	11.7	—	dB
Collector Efficiency ( $V_{CC} = 26\text{ Vdc}$ , $P_{out} = 60\text{ Watts (PEP)}$ , $I_{CQ} = 200\text{ mA}$ , $f_1 = 1490.0\text{ MHz}$ , $f_2 = 1490.1\text{ MHz}$ )	$\eta$	33	38	—	dB
3rd Order Intermodulation Distortion ( $V_{CC} = 26\text{ Vdc}$ , $P_{out} = 60\text{ Watts (PEP)}$ , $I_{CQ} = 200\text{ mA}$ , $f_1 = 1490.0\text{ MHz}$ , $f_2 = 1490.1\text{ MHz}$ )	IMD	—	– 32	– 28	dB
Input Return Loss ( $V_{CC} = 26\text{ Vdc}$ , $P_{out} = 60\text{ Watts (PEP)}$ , $I_{CQ} = 200\text{ mA}$ , $f_1 = 1490.0\text{ MHz}$ , $f_2 = 1490.1\text{ MHz}$ )	IRL	12	20	—	dB
Output Mismatch Stress ( $V_{CC} = 26\text{ Vdc}$ , $P_{out} = 60\text{ Watts (PEP)}$ , $I_{CQ} = 200\text{ mA}$ , $f_1 = 1490.0\text{ MHz}$ , $f_2 = 1490.1\text{ MHz}$ , $V_{SWR} = 3:1$ , at All Phase Angles)	$\psi$	No Degradation in Output Power			

(1) For information only. This part is collector matched.

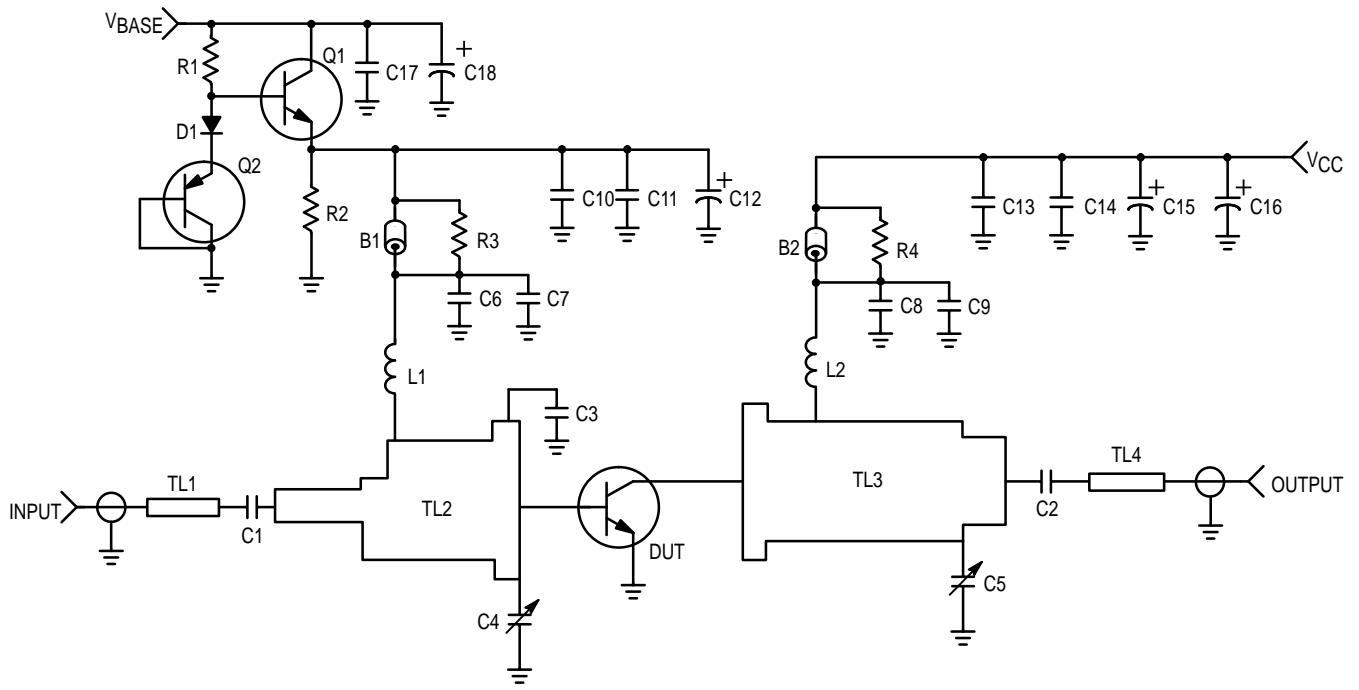

B1, B2	Short RF Bead Fair Rite-2743019447	D1	Diode, 1N4003
C1, C2, C6, C8	18 pF, Chip Capacitor	L1, L2	3 Turns, 20 AWG, IDIA 0.102" (17.7 nH)
C3	3.9 pF, Chip Capacitor	Q1	Transistor, NPN BD135
C4, C5	0.6–4.5 pF, Variable Capacitor	Q2	Transistor, PNP BD136
C7, C9	100 pF, Chip Capacitor	R1	120 $\Omega$ , 1/4 W Resistor
C10, C13	1000 pF, Chip Capacitor	R2	51 $\Omega$ , 1/4 W, Chip Resistor
C11, C14, C17	0.1 $\mu$ F, 50 Vdc Ceramic Capacitor	R3, R4	4 x 39 $\Omega$ , 1/8 W Chip Resistors
C12, C15, C18	10 $\mu$ F, 50 Vdc Electrolytic Capacitor	TL1–TL4	Microstrip Line See Photomaster
C16	250 $\mu$ F, 50 Vdc Electrolytic Capacitor	Board	1/32" Glass Teflon <sup>®</sup> , Arlon GX-0300-55-22, $\epsilon_r = 2.55$

Figure 1. MRF15060 RF Test Fixture Schematic

## TYPICAL CHARACTERISTICS

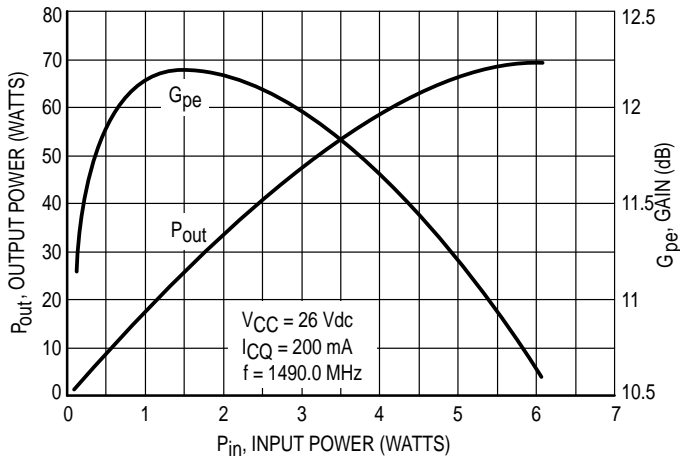

**Figure 2. Output Power & Power Gain versus Input Power**

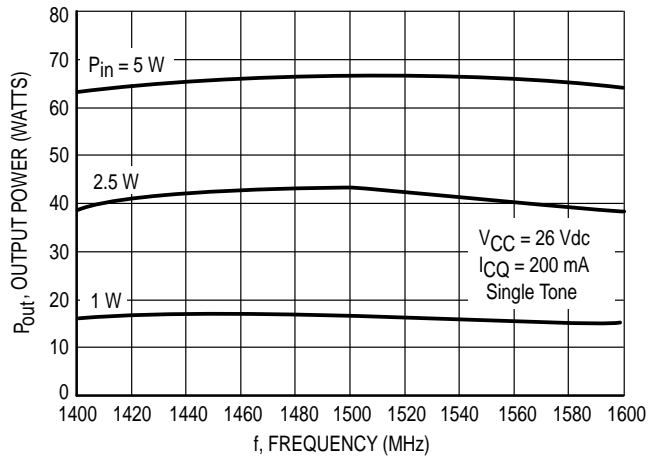

**Figure 3. Output Power versus Frequency**

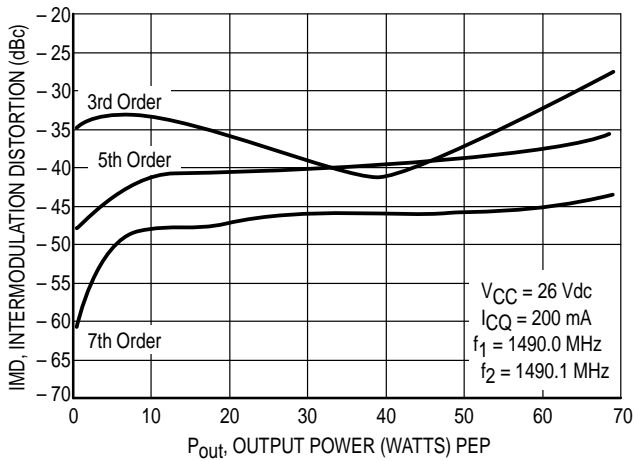

**Figure 4. Intermodulation Distortion versus Output Power**

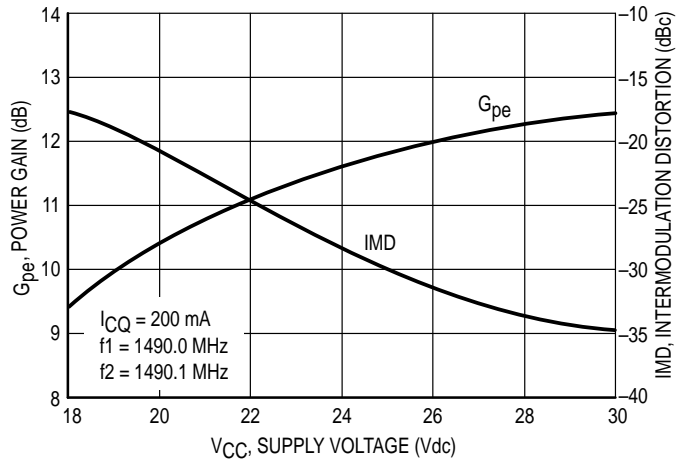

**Figure 5. Power Gain and Intermodulation Distortion versus Supply Voltage**

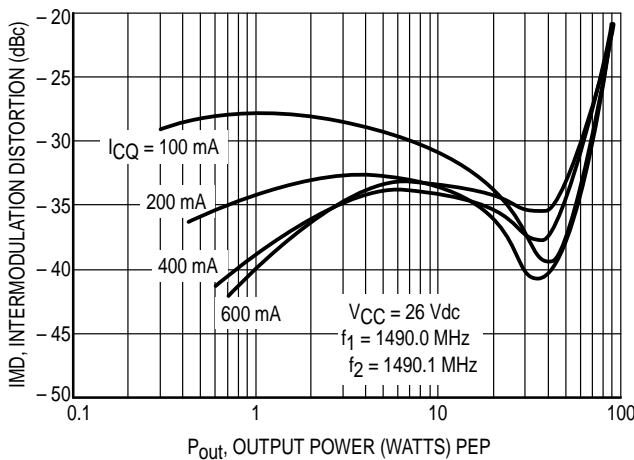

**Figure 6. Intermodulation Distortion versus Output Power**

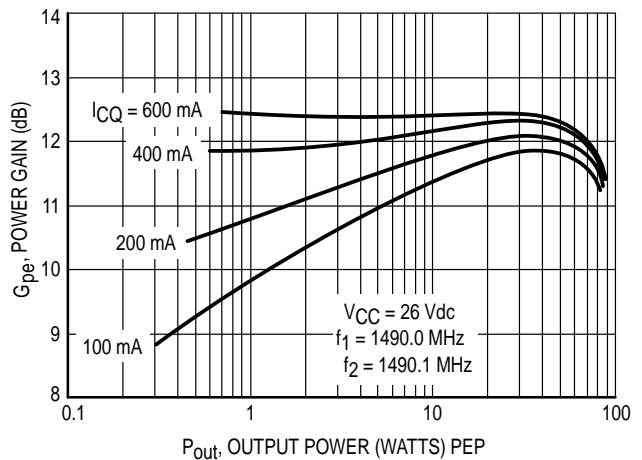

**Figure 7. Power Gain versus Output Power**

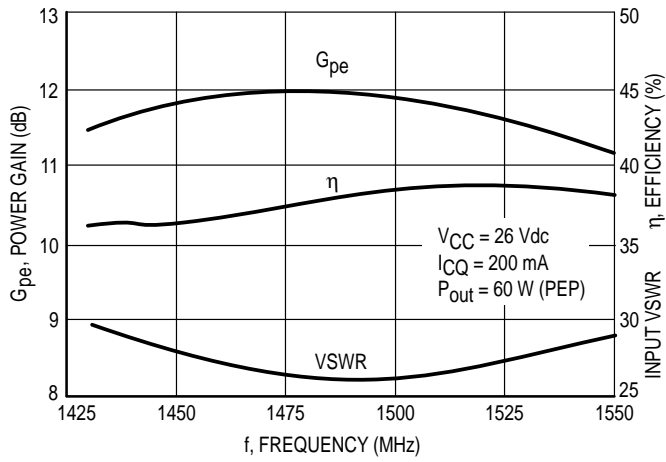

Figure 8. Performance in Broadband Circuit

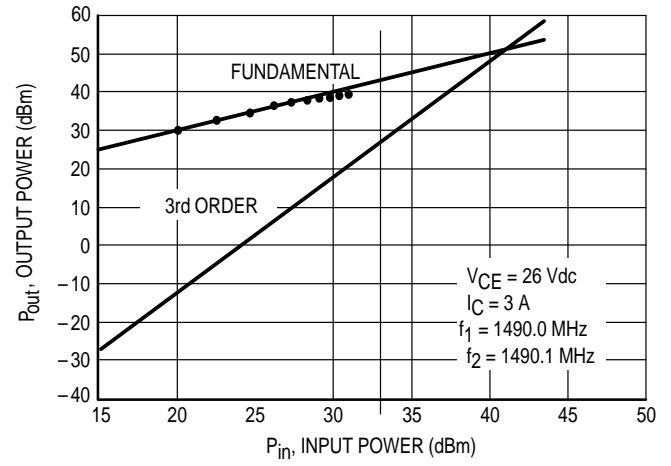

Figure 9. Class A Third Order Intercept Point

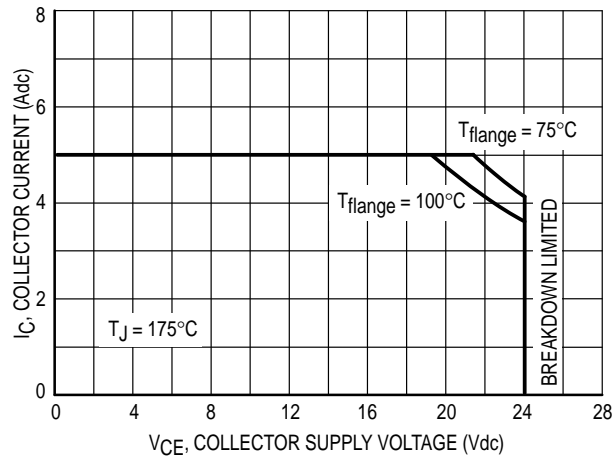
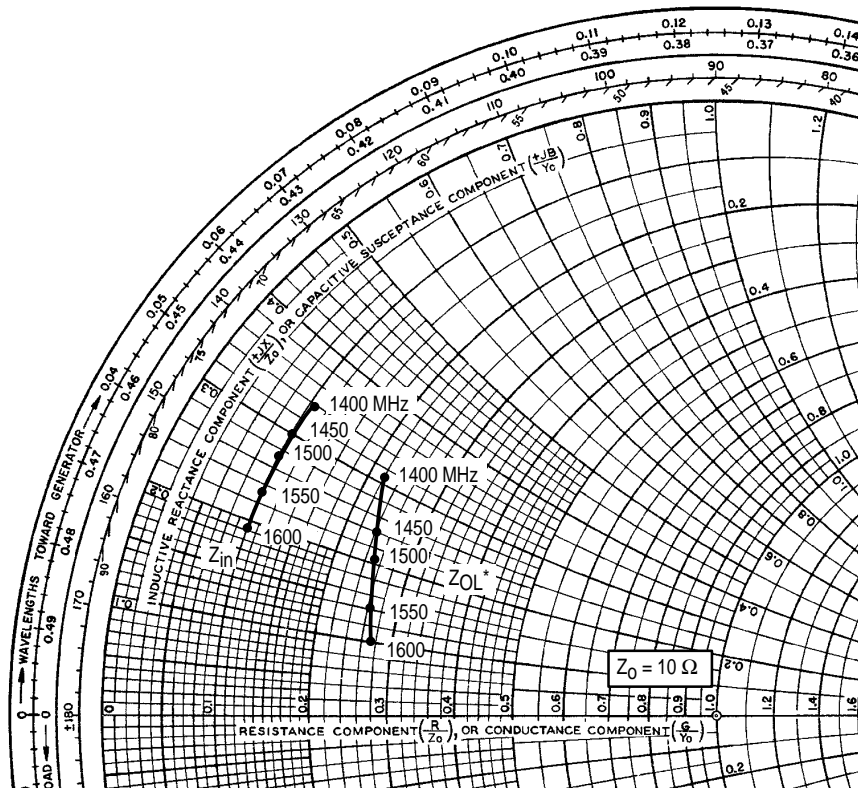

Figure 10. DC Safe Operating Area



$V_{CC} = 26 \text{ Vdc}$ ,  $I_{CQ} = 200 \text{ mA}$ ,  $P_{Out} = 60 \text{ Watts PEP}$

f MHz	$Z_{in}(1)$ Ohms	$Z_{OL}^*$ Ohms
1400	$1.07 + j3.4$	$2.25 + j3.1$
1450	$1.04 + j3.0$	$2.37 + j2.4$
1500	$1.01 + j2.7$	$2.46 + j2.1$
1550	$0.99 + j2.3$	$2.54 + j1.4$
1600	$0.97 + j1.9$	$2.66 + j1.0$

$Z_{in}(1) =$  Conjugate of fixture base impedance.

$Z_{OL}^* =$  Conjugate of the optimum load impedance at given output power, voltage, bias current and frequency.

**Figure 11. Series Equivalent Input and Output Impedance**

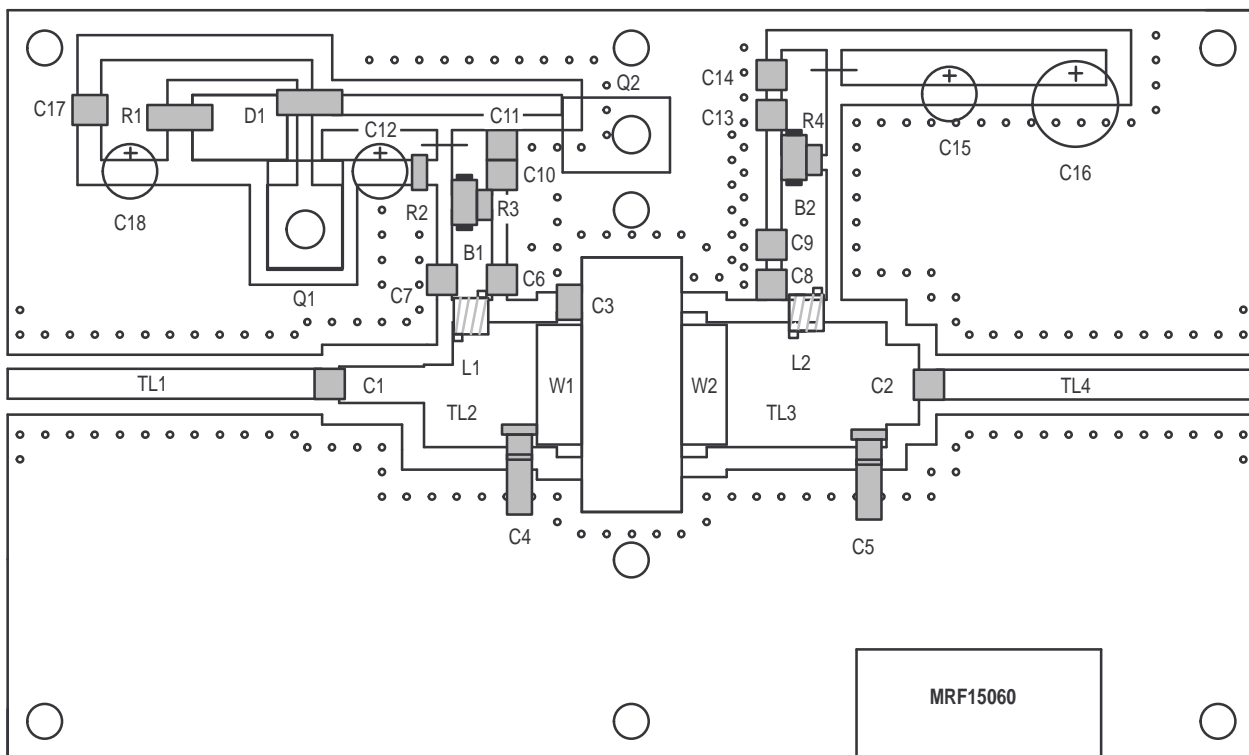

Figure 12. MRF15060 Component Parts Layout

Table 1. Typical Common Emitter S-Parameters ( $V_{CC} = 26\text{ V}$ )

$I_D = 3.0\text{ A}$

f MHz	S <sub>11</sub>		S <sub>21</sub>		S <sub>12</sub>		S <sub>22</sub>	
	S <sub>11</sub>	∠φ	S <sub>21</sub>	∠φ	S <sub>12</sub>	∠φ	S <sub>22</sub>	∠φ
1000	0.964	163	0.28	93	0.018	73	0.991	178
1050	0.958	162	0.30	87	0.018	76	0.989	178
1100	0.957	161	0.31	82	0.017	81	0.987	179
1150	0.956	160	0.34	76	0.022	73	0.982	179
1200	0.955	158	0.38	70	0.023	67	0.969	179
1250	0.953	157	0.42	62	0.022	57	0.956	180
1300	0.941	155	0.47	53	0.019	60	0.937	180
1350	0.922	154	0.55	43	0.015	64	0.915	-180
1400	0.920	153	0.67	28	0.013	66	0.891	-180
1450	0.901	152	0.80	6	0.012	71	0.880	-180
1500	0.903	151	0.83	-24	0.007	76	0.911	-179
1550	0.906	152	0.70	-54	0.008	89	0.954	-180
1600	0.913	153	0.51	-75	0.009	92	0.971	-180
1650	0.921	154	0.38	-89	0.010	95	0.973	-179
1700	0.946	154	0.29	-98	0.012	97	0.974	-179
1750	0.974	155	0.34	-107	0.014	105	0.976	-178
1800	0.968	154	0.19	-115	0.016	116	0.977	-178
1850	0.966	153	0.16	-121	0.018	138	0.978	-177
1900	0.947	152	0.14	-128	0.021	143	0.980	-177
1950	0.918	151	0.12	-138	0.027	151	0.982	-177
2000	0.912	150	0.09	-146	0.031	159	0.985	-176

## PACKAGE DIMENSIONS

**CASE 451-04  
ISSUE D**

NOTES:

- DIMENSIONING AND TOLERANCING PER ANSI Y14.5M, 1982.
- CONTROLLING DIMENSION: INCH.

DIM	INCHES		MILLIMETERS	
	MIN	MAX	MIN	MAX
A	0.995	1.005	25.27	25.53
B	0.380	0.390	9.65	9.91
C	0.170	0.205	4.32	5.21
D	0.455	0.465	11.56	11.81
E	0.060	0.075	1.52	1.91
F	0.004	0.006	0.10	0.15
G	0.800 BSC		20.32 BSC	
H	0.078	0.090	1.98	2.29
K	0.117	0.137	2.97	3.48
N	0.595	0.605	15.11	15.37
Q	0.120	0.130	3.05	3.30
R	0.395	0.410	10.03	10.41

STYLE 1:  
PIN 1. COLLECTOR  
2. BASE  
3. EMITTER

**CASE 451A-01  
ISSUE O**

NOTES:

- DIMENSIONING AND TOLERANCING PER ANSI Y14.5M, 1982.
- CONTROLLING DIMENSION: INCH.

DIM	INCHES		MILLIMETERS	
	MIN	MAX	MIN	MAX
A	0.615	0.625	15.62	15.88
B	0.395	0.410	10.03	10.41
C	0.170	0.205	4.32	5.21
D	0.455	0.465	11.56	11.81
E	0.060	0.075	1.52	1.91
F	0.004	0.006	0.10	0.15
H	0.078	0.090	1.98	2.29
K	0.117	0.137	2.97	3.48
N	0.595	0.605	15.11	15.37

STYLE 1:  
PIN 1. COLLECTOR  
2. BASE  
3. EMITTER

Motorola reserves the right to make changes without further notice to any products herein. Motorola makes no warranty, representation or guarantee regarding the suitability of its products for any particular purpose, nor does Motorola assume any liability arising out of the application or use of any product or circuit, and specifically disclaims any and all liability, including without limitation consequential or incidental damages. "Typical" parameters which may be provided in Motorola data sheets and/or specifications can and do vary in different applications and actual performance may vary over time. All operating parameters, including "Typicals" must be validated for each customer application by customer's technical experts. Motorola does not convey any license under its patent rights nor the rights of others. Motorola products are not designed, intended, or authorized for use as components in systems intended for surgical implant into the body, or other applications intended to support or sustain life, or for any other application in which the failure of the Motorola product could create a situation where personal injury or death may occur. Should Buyer purchase or use Motorola products for any such unintended or unauthorized application, Buyer shall indemnify and hold Motorola and its officers, employees, subsidiaries, affiliates, and distributors harmless against all claims, costs, damages, and expenses, and reasonable attorney fees arising out of, directly or indirectly, any claim of personal injury or death associated with such unintended or unauthorized use, even if such claim alleges that Motorola was negligent regarding the design or manufacture of the part. Motorola and are registered trademarks of Motorola, Inc. Motorola, Inc. is an Equal Opportunity/Affirmative Action Employer.

**How to reach us:**

**USA/EUROPE/Locations Not Listed:** Motorola Literature Distribution;  
P.O. Box 20912; Phoenix, Arizona 85036. 1-800-441-2447 or 602-303-5454

**MFAX:** RMFAX0@email.sps.mot.com - TOUCHTONE 602-244-6609  
**INTERNET:** <http://Design-NET.com>

**JAPAN:** Nippon Motorola Ltd.; Tatsumi-SPD-JLDC, 6F Seibu-Butsuryu-Center,  
3-14-2 Tatsumi Koto-Ku, Tokyo 135, Japan. 03-81-3521-8315

**ASIA/PACIFIC:** Motorola Semiconductors H.K. Ltd.; 8B Tai Ping Industrial Park,  
51 Ting Kok Road, Tai Po, N.T., Hong Kong. 852-26629298

