

The RF Line Microwave Pulse Power Transistors

... designed for Class B and C common base amplifier applications in short and long pulse TACAN, IFF, DME, and radar transmitters.

- Guaranteed Performance @ 1090 MHz, 50 Vdc
Output Power = 15 Watts Peak
Minimum Gain = 10 dB
- 100% Tested for Load Mismatch at All Phase Angles with 10:1 VSWR
- Industry Standard Package
- Nitride Passivated
- Gold Metallized, Emitter Ballasted for Long Life and Resistance to Metal Migration
- Internal Input Matching for Broadband Operation
- Circuit board photomaster available upon request by contacting RF Tactical Marketing in Phoenix, AZ.

MRF1015MA
MRF1015MB

15 W (PEAK), 960–1215 MHz
MICROWAVE POWER
TRANSISTORS
NPN SILICON

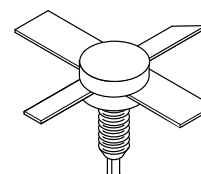

CASE 332-04, STYLE 1
MRF1015MA

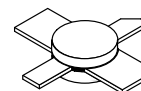

CASE 332A-03, STYLE 1
MRF1015MB

MAXIMUM RATINGS

Rating	Symbol	Value	Unit
Collector–Emitter Voltage	V_{CES}	60	Vdc
Collector–Base Voltage	V_{CBO}	60	Vdc
Emitter–Base Voltage	V_{EBO}	4.0	Vdc
Collector Current — Continuous	I_C	1.0	Adc
Total Device Dissipation @ $T_C = 25^\circ\text{C}$ (1) Derate above 25°C	P_D	17.5 100	Watts mW/ $^\circ\text{C}$
Storage Temperature Range	T_{stg}	-65 to +150	$^\circ\text{C}$

THERMAL CHARACTERISTICS

Characteristic	Symbol	Max	Unit
Thermal Resistance, Junction to Case (2)	$R_{\theta JC}$	10	$^\circ\text{C}/\text{W}$

ELECTRICAL CHARACTERISTICS ($T_C = 25^\circ\text{C}$ unless otherwise noted.)

Characteristic	Symbol	Min	Typ	Max	Unit
----------------	--------	-----	-----	-----	------

OFF CHARACTERISTICS

Collector–Emitter Breakdown Voltage ($I_C = 10\text{ mAdc}$, $V_{BE} = 0$)	$V_{(BR)CES}$	60	—	—	Vdc
Collector–Base Breakdown Voltage ($I_C = 10\text{ mAdc}$, $I_E = 0$)	$V_{(BR)CBO}$	60	—	—	Vdc
Emitter–Base Breakdown Voltage ($I_E = 1.0\text{ mAdc}$, $I_C = 0$)	$V_{(BR)EBO}$	4.0	—	—	Vdc
Collector Cutoff Current ($V_{CB} = 50\text{ Vdc}$, $I_E = 0$)	I_{CBO}	—	—	1.0	mAdc

ON CHARACTERISTICS

DC Current Gain ($I_C = 250\text{ mAdc}$, $V_{CE} = 5.0\text{ Vdc}$)	h_{FE}	10	40	100	—
--	----------	----	----	-----	---

NOTES:

(continued)

1. These devices are designed for RF operation. The total device dissipation rating applies only when the device is operated as RF amplifiers.
2. Thermal Resistance is determined under specified RF operating conditions by infrared measurement techniques.

ELECTRICAL CHARACTERISTICS — continued ($T_C = 25^\circ\text{C}$ unless otherwise noted.)

Characteristic	Symbol	Min	Typ	Max	Unit
DYNAMIC CHARACTERISTICS					
Output Capacitance ($V_{CB} = 50\text{ Vdc}$, $I_E = 0$, $f = 1.0\text{ MHz}$)	C_{ob}	—	5.0	7.5	pF
FUNCTIONAL TESTS (Pulse Width = $10\ \mu\text{s}$, Duty Cycle = 1.0%)					
Common-Base Amplifier Power Gain ($V_{CC} = 50\text{ Vdc}$, $P_{out} = 15\text{ W Peak}$, $f = 1090\text{ MHz}$)	G_{PB}	10	12.5	—	dB
Collector Efficiency ($V_{CC} = 50\text{ Vdc}$, $P_{out} = 15\text{ W Peak}$, $f = 1090\text{ MHz}$)	η	30	35	—	%
Load Mismatch ($V_{CC} = 50\text{ Vdc}$, $P_{out} = 15\text{ W Peak}$, $f = 1090\text{ MHz}$, $VSWR = 10:1$ All Phase Angles)	ψ	No Degradation in Power Output			

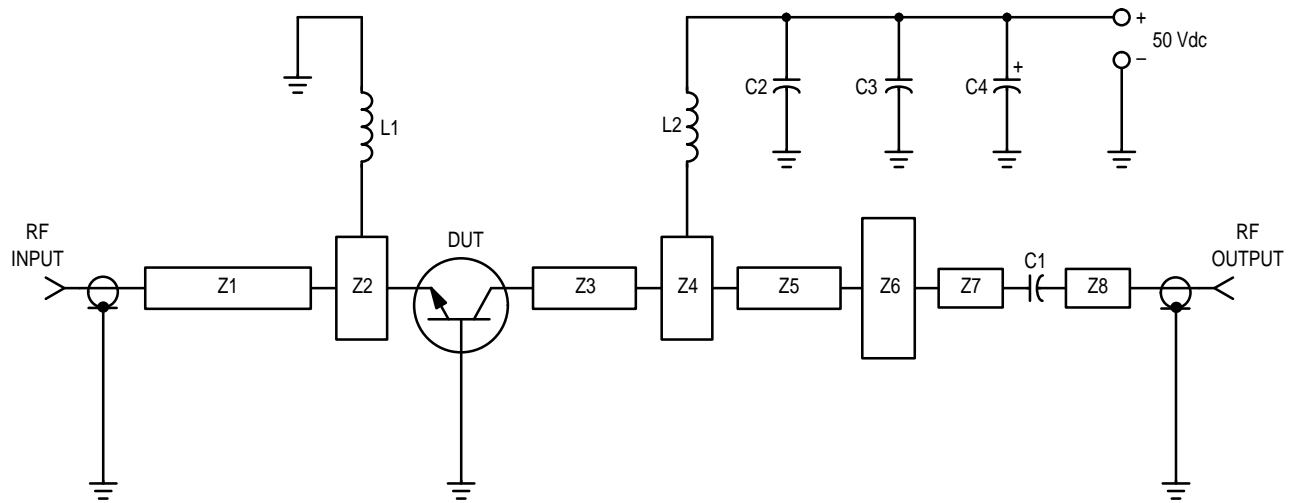

C1, C2 — 220 pF 100 mil Chip Capacitor
 C3 — 0.1 μF
 C4 — 47 $\mu\text{F}/75\text{ V}$ Electrolytic Capacitor
 L1, L2 — 3 Turns #18 AWG, 1/8" ID
 Z1-Z8 — Microstrip, See Photomaster
 Board Material — 0.032" Glass Teflon
 $\epsilon_r = 2.5$

Figure 1. 1090 MHz Test Circuit

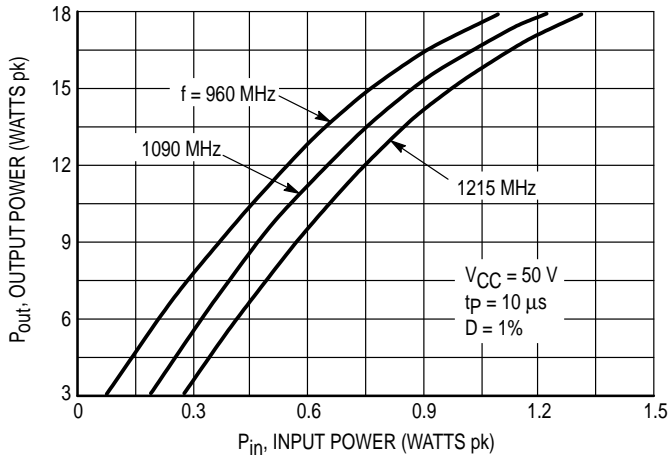

Figure 2. Output Power versus Input Power

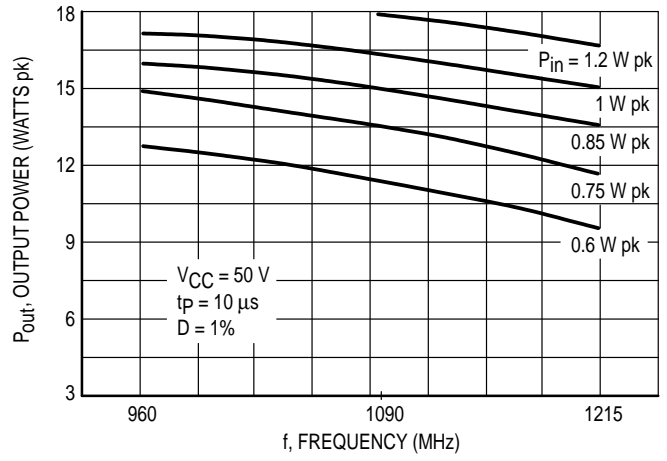

Figure 3. Output Power versus Frequency

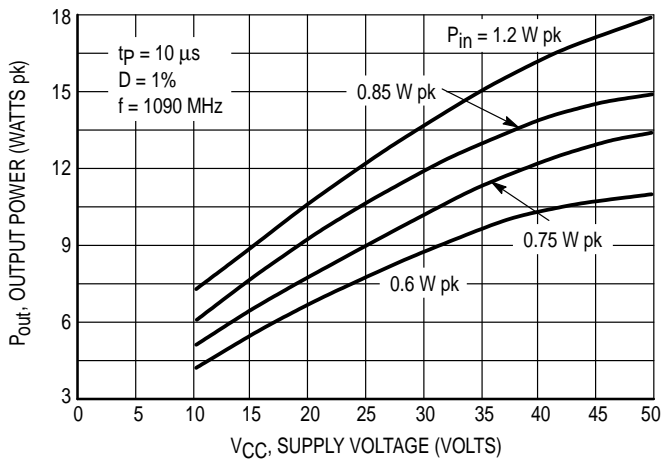

Figure 4. Output Power versus Supply Voltage

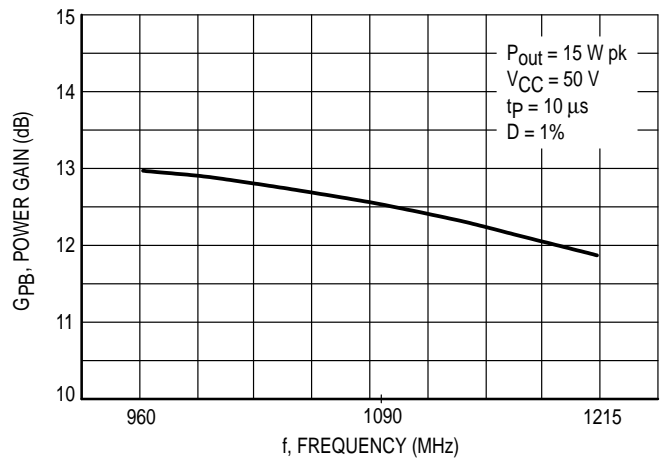
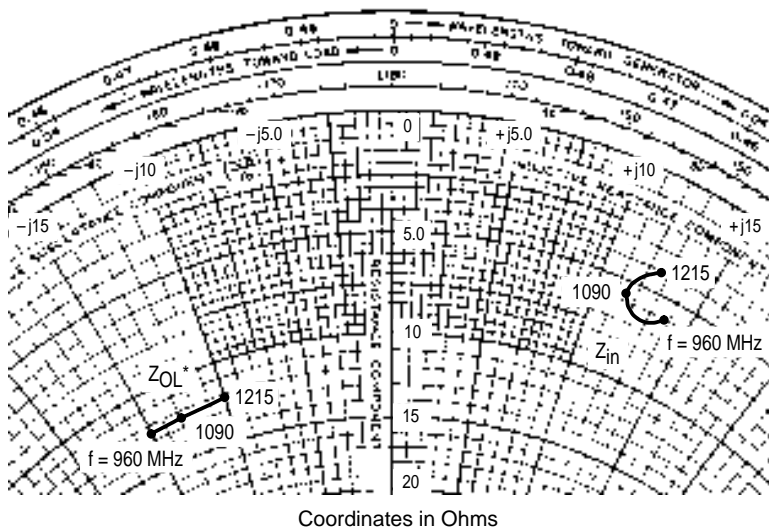

Figure 5. Power Gain versus Frequency



$P_{out} = 15 \text{ W pk}$ $V_{CC} = 50 \text{ V}$
 $t_p = 10 \mu\text{s}$ $D = 1\%$

f MHz	Z_{in} Ohms	Z_{OL}^* Ohms
960	$5.9 + j13.6$	$12.5 - j15$
1090	$5.5 + j11.5$	$12.4 - j12.8$
1215	$4.0 + j12.5$	$12.1 - j10$

Z_{OL}^* = Conjugate of the optimum load impedance into which the device output operates at a given output power, voltage, and frequency.

Figure 6. Series Equivalent Input/Output Impedances

PACKAGE DIMENSIONS

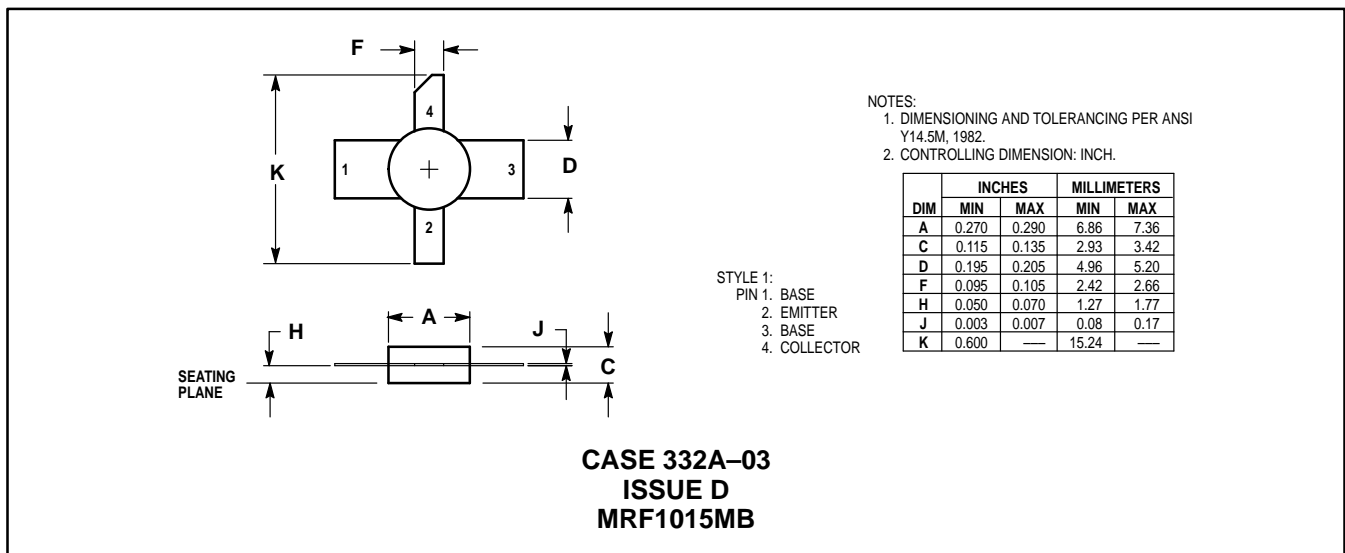
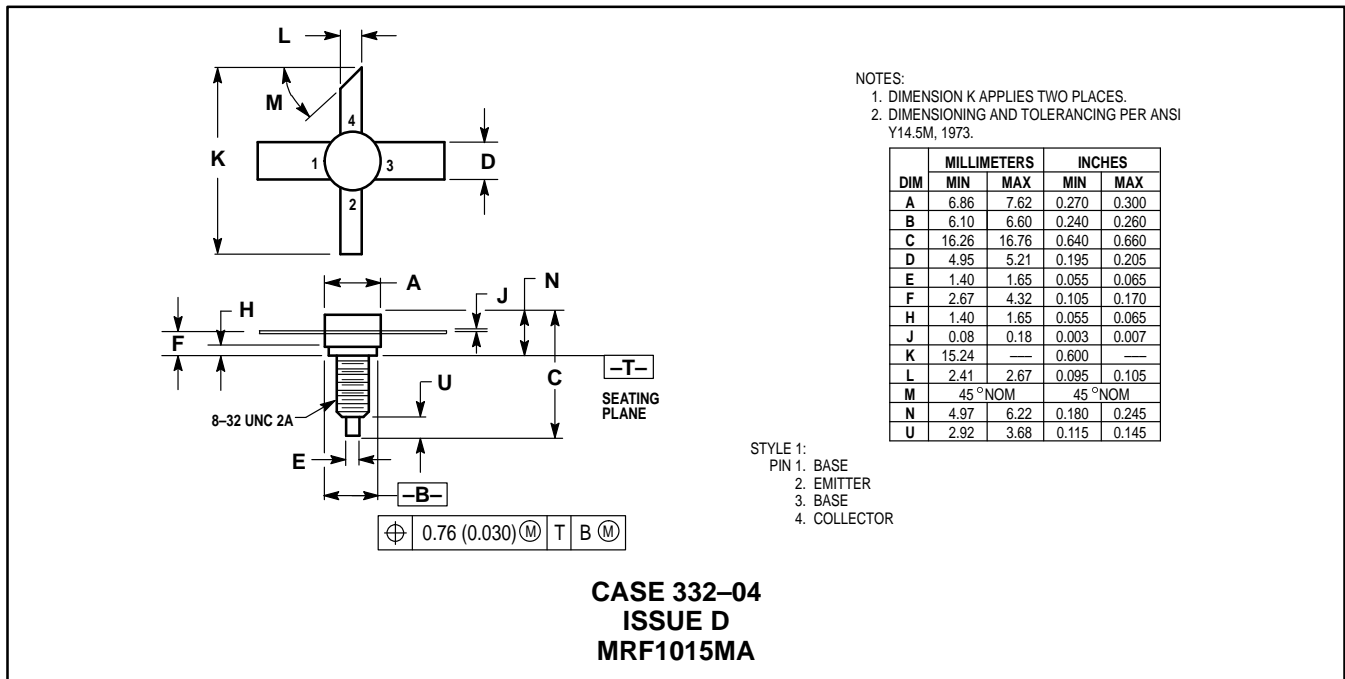

Motorola reserves the right to make changes without further notice to any products herein. Motorola makes no warranty, representation or guarantee regarding the suitability of its products for any particular purpose, nor does Motorola assume any liability arising out of the application or use of any product or circuit, and specifically disclaims any and all liability, including without limitation consequential or incidental damages. "Typical" parameters can and do vary in different applications. All operating parameters, including "Typicals" must be validated for each customer application by customer's technical experts. Motorola does not convey any license under its patent rights nor the rights of others. Motorola products are not designed, intended, or authorized for use as components in systems intended for surgical implant into the body, or other applications intended to support or sustain life, or for any other application in which the failure of the Motorola product could create a situation where personal injury or death may occur. Should Buyer purchase or use Motorola products for any such unintended or unauthorized application, Buyer shall indemnify and hold Motorola and its officers, employees, subsidiaries, affiliates, and distributors harmless against all claims, costs, damages, and expenses, and reasonable attorney fees arising out of, directly or indirectly, any claim of personal injury or death associated with such unintended or unauthorized use, even if such claim alleges that Motorola was negligent regarding the design or manufacture of the part. Motorola and are registered trademarks of Motorola, Inc. Motorola, Inc. is an Equal Opportunity/Affirmative Action Employer.

Literature Distribution Centers:

USA: Motorola Literature Distribution; P.O. Box 20912; Phoenix, Arizona 85036.
 EUROPE: Motorola Ltd.; European Literature Centre; 88 Tanners Drive, Blakelands, Milton Keynes, MK14 5BP, England.
 JAPAN: Nippon Motorola Ltd.; 4-32-1, Nishi-Gotanda, Shinagawa-ku, Tokyo 141, Japan.
 ASIA PACIFIC: Motorola Semiconductors H.K. Ltd.; Silicon Harbour Center, No. 2 Dai King Street, Tai Po Industrial Estate, Tai Po, N.T., Hong Kong.

