

Specifications (Ver. 2.0)
MPEG2 MOTION ESTIMATION LSI (M65727FP)

December 1, 1995
Mitsubishi Electric Corporation

CONTENTS

1. Outline
 - 1.1 Outline
 - 1.2 Characteristics

2. Pin Listing and Description
 - 2.1 Pin Listing
 - 2.2 Pin Description
 - 2.2.1 Data I/O Ports
 - 2.2.2 System Control Pins
 - 2.2.3 Input Pins for Sync. Signals
 - 2.2.4 Pins Specifying Operational Modes
 - 2.2.5 Others

3. Outline of Functions
 - 3.1 Outline
 - 3.2 Block Configuration
 - 3.2.1 Input Unit
 - 3.2.2 Integer Pel Unit
 - 3.2.3 Motion Detection Unit
 - 3.2.4 Half-Pel/Dual-Prime Unit
 - 3.2.5 Output Unit
 - 3.3 Operation modes
 - 3.3.1 Field/Frame/Field Dual-Prime/Frame Dual-Prime
 - 3.3.2 Horizontal Search Range
 - 3.3.3 Vertical Search Range
 - 3.3.4 Search range expansion for Vertical Direction
 - 3.3.5 Half-Pel Precision/Integer-Pel Precision
 - 3.3.6 External Frame Memory Data Format
 - 3.3.7 Operation Modes and Output Data
 - 3.3.8 Operation Modes and Dynamic Control Signals

4. Operations
 - 4.1 Reset Operation
 - 4.2 Wait Operation
 - 4.3 Motion Estimation Operation
 - 4.3.1 Search Window Image Input for Field/Frame mode
 - 4.3.2 Search Window Image Input for Dual-Prime mode
 - 4.3.3 Template MB Data Input
 - 4.3.4 Output Request
 - 4.3.5 Activation of Execution Cycle
 - 4.3.6 Dynamic Control Input
 - 4.3.7 Number of Cycles Needed (from Data Input to Data Output)

- 5. Others
 - 5.1 Macro Block Processing for Missing Search Range
 - 5.2 Priority Order for Distortion Equivalent Vector
 - 5.3 Detail of Vector Search Range
 - 5.4 Formats for External Frame Memory (Search Window Image Memory)
 - 5.5 Expansion of Search Range and Controlling the Validity of Search Range
 - 5.6 Operational Timing
 - 5.7 Treatment of Final MB
 - 5.8 Mode Change during Processing

- 6. Electrical Characteristics and Others
 - 6.1 Electrical Characteristics
 - 6.1.1 Maximum Ratings
 - 6.1.2 Operating Range
 - 6.1.3 Electrical Characteristics
 - 6.1.4 Switching Characteristics
 - 6.1.5 Set-up and Hold Times
 - 6.2 Package
 - 6.3 Thermal Management

1. Outline

1.1 Outline

The M65727 is a highly efficient motion estimation LSI used to estimate motion vectors for real-time encoding of dynamic images. M65727 can be used together with the frame memory, the M65721 (Controller LSI) and the M65722 (Pixel Processor LSI). It operates under the control of the M65721. M65727 accepts the template macro block (MB) data inputs from the M65721 and accepts the search window image data from the frame memory. It estimate the motion vectors by searching the minimum value of the mean absolute error between template block data and search window image data. It outputs the result to the M65721. The M65721 and the M65722 are able to generate prediction image using the above mentioned motion vector. The M65727 is designed so that it is applicable to MPEG2, the international video compression standard.

[Main Specifications]

Field Mode (per field)

- *Block size 16x16 and 16x8 (Upper), 16x8 (Lower) simultaneously
- *Search range Vertical direction: $\pm 7.5(*A) / \pm 15.5$ pixel (Switchable)
However, $\pm 8.0(*A) / \pm 16.0$ are used during expansion respectively
Horizontal direction: $\pm 7.5 / \pm 15.5 / \pm 31.5 / \pm 63.5 / \pm 127.5$ pixel
(Selectable)
- *Search methods Integer-pel precision exhaustive search
Half-pel precision 9 points around the best integer-pel precision vector
(Including the integer precision location)
- *Evaluation function Full sampled mean absolute error
- *Execution cycle Dependent on the search range
The execution cycle mentioned here refers to the throw-in period of MB,
not the 1MB processing time.
 - ex. 1 (Horizontal ± 7.5 , vertical ± 7.5) (550) cycles / MB
 - ex. 2 (Horizontal ± 15.5 , vertical ± 7.5) (550) *2 cycles / MB
 - ex. 3 (Horizontal ± 7.5 , vertical ± 15.5) (806) cycles / MB
 - ex. 4 (Horizontal ± 15.5 , vertical ± 15.5) (806) *2 cycles / MB
- *Search window image inputs
When vertical ± 7.5 is searched: 512 pixels / (550) cycles
When vertical ± 15.5 is searched: 768 pixels / (806) cycles
- *Processing capability
27MHz operation: Processing the search range over horizontal ± 7.5 and
vertical ± 7.5 for the ITU-R 601 image size is possible.
40MHz operation: Processing the search range over horizontal ± 7.5
and vertical ± 15.5 for the ITU-R 601 image size is possible.

*A: The mode of vertical search range is ± 7.5 can be used only under 27MHz operation.

Frame Mode (per frame)

- *Block size 16x16 and 16x8 (Top*), 16x8 (Bottom**) simultaneously
- *Search range Vertical direction: $\pm 7.5(*A) / \pm 15.5$ pixel (Switchable)
It corresponds to 2 sets of fields each ± 3.5 pixel / ± 7.5 pixel location for 16x8 blocks.
However, $\pm 8.0(*A) / \pm 16.0$ are used during expansion respectively
Horizontal direction: $\pm 7.5 / \pm 15.5 / \pm 31.5 / \pm 63.5 / \pm 127.5$ pixel (Selectable)
- *Search methods Integer-pel precision exhaustive search
Half-pel precision 9 points around the best integer-pel precision vector (Including the integer precision location)
- *Evaluation function Full sampled mean absolute error
- *Execution cycle Depends on the search range
The execution cycle mentioned here refers to the throw-in period of MB, not the 1MB processing time.
ex. 1 (Horizontal ± 7.5 , vertical ± 7.5) (550) cycles/ MB
ex. 2 (Horizontal ± 15.5 , vertical ± 7.5) (550) *2 cycles / MB
ex. 3 (Horizontal ± 7.5 , vertical ± 15.5) (806) cycles / MB
ex. 4 (Horizontal ± 15.5 , vertical ± 15.5) (806) *2 cycles / MB
- *Search window image inputs
When vertical ± 7.5 is searched: 512 pixels / (550) cycles
When vertical ± 15.5 is searched: 768 pixels / (806) cycles
- *Processing capability
27MHz operation: Processing the search range over horizontal ± 7.5 and vertical ± 7.5 for the ITU-R 601 image size is possible.
40MHz operation: Processing the search range over horizontal ± 7.5 and vertical ± 15.5 for the ITU-R 601 image size is possible.

*, **: "Top" and "Bottom" mentioned here indicate the field parities. In the following explanation, a frame with the top field side as the first line is assumed.

*A: The mode of vertical search range is ± 7.5 can be used only under 27MHz operation.

Field Dual-Prime Mode

- *Block size 16x16
- *Search range Second field: horizontal ± 0.5 pixel, vertical: ± 0.5 pixel
- *Search method Take the average with the first field data (half-pel is generated as needed) and estimate 9 points over the second field (including the specified point)
- *Evaluation function Full sampled mean absolute error
- *Execution cycle The execution cycle mentioned here refers to the throw-in period of MB, not the 1MB processing time. (550) cycles / MB
- *Search window image inputs
 - First field: 432 (18x24) pixel / (550) cycles
 - Second field: 432 (18x24) pixel / (550) cycles
- *Processing capability 27MHz operation: Processing the search range over horizontal ± 7.5 and vertical ± 7.5 for the ITU-R 601 image size is possible.

Frame Dual Prime Mode

- *Block size 16x8
 - *Search range Second field: horizontal ± 0.5 pixel, vertical: ± 0.5 pixel
 - *Search method Take the average with the first field data (half-pel is generated as needed) and estimate 9 points over the second field (including the specified point)
Not only the minimum evaluation value, but also all the 9 points are stored and output.
 - *Execution cycle The execution cycle mentioned here refers to the throw-in period of MB, not the 1MB processing time. (550) cycles / MB
 - *Search window image inputs
 - First field: 288 (18x16) pixel / (550) cycles
 - Second field: 288 (18x16) pixel / (550) cycles
 - *Processing capability 27MHz operation: Processing the search range over horizontal ± 7.5 and vertical ± 7.5 for the ITU-R 601 image size is possible.
- ***: The Frame Dual-Prime Mode supports a part of Dual-Prime prediction specified by the MPEG2.

Items common to modes

- *Maximum operating frequency 40.5MHz (24.6ns)
- *Two input ports:
 - Port 1 Search window image data, 32 bit
 - Port 2 Template MB data, 8 bit
- *Output port 8 bit output port

1.2 Characteristics

The M65727 has the following characteristics.

*Highly efficient parallel architecture for high speed processing and data transfer, which eliminates I/O bottleneck.

*Supports prediction modes for MPEG2, Field prediction, Frame prediction, Field Dual-Prime prediction and Frame Dual-Prime prediction.

*For Field Mode and Frame Mode, it is possible to do simultaneous vector search over 16x16 and two 16x8 blocks.

*Implementing low cost image compression hardware is possible using DRAM frame memory in a 32 bit DRAM interface.

*Estimates half-pel precision vectors in a chip.

*The exhaustive search method is used over the integer-pel precision vectors in a search range. Evaluation function is full sampled mean absolute error.

*The M65727's scalable architecture allows wider search range with multiple-chip configuration. When expanding the horizontal search range, it is possible to use a common search window image data into all chips.

2. Explanation of Pins

2.1 List of Pins

Table 1 shows the list of pins of M65727.

Table 1 List of M65727 Pins

Pin names	Number of Pins	Type	Remarks
DSWI [31:0]	32	I	SEARCH WINDOW IMAGE DATA INPUT
DMBI [7:0]	8	I	TEMPLATE MB DATA INPUT
DOUT [7:0]	8	O	RESULTS OUTPUT
CLKI	1	I	CLOCK INPUT
RESETC	1	I	RESET
CEC	1	I	CLOCK ENABLE
DENSWC	1	I	DSWI INPUT DATA ENABLE
DENMBC	1	I	DMBI INPUT DATA ENABLE
OEC	1	I	OUTPUT ENABLE
SSYNC	1	I	DSWI INPUT SYNC SIGNAL
MSYNC	1	I	DMBI INPUT SYNC SIGNAL
ESYNC	1	I	PROCESS EXECUTION SYNC SIGNAL
DSYNC	1	I	DYNAMIC CONTROL SYNC SIGNAL
OREQC	1	I	OUTPUT REQUEST SIGNAL
MODE [1:0]	2	I	SPECIFIES OPERATION MODE FIELD, FRAME, FIELD DUAL-PRIME, FRAME DUAL-PRIME
HSIZE [2:0]	3	I	HORIZONTAL SEARCH RANGE $\pm 7.5, \pm 15.5, \pm 31.5, \pm 63.5, \pm 127.5$
VSIZE	1	I	VERTICAL SEARCH RANGE $\pm 7.5, \pm 15.5$
EXTND [1:0]	2	I	VERTICAL SEARCH RANGE EXTENSION
HLFPL	1	I	VECTOR PRECISION
FMFMT	1	I	FRAME MEMORY FORMAT
DCNT [3:0]	4	I	DYNAMIC CONTROL INPUT
TEST [6:0]	7	I	TEST PIN
VDD	19	I	POWER
GND	19	I	GND

2.2 Explanation of Pins

Functions and uses of M65727 pins are explained below. Refer to "2.1 List of Pins" for the bit configuration of terminals and I/O attributes.

The term Execution cycle used in this explanation refers to 550 / 806 . It means that the above cycle is capable of vector detection within a search range of -7 (-8) ~ +7 horizontally using integer precision. When the horizontal search area is greater than or equal ± 15 , the integer precision operation requires multiple execution cycles.

2.2.1 Data I/O Ports

DSWI	This is the 32 bit wide search window image data input port. The search window image input is processed in parallel with the arithmetic operation. Therefore, the data inputted will be used in the next execution cycle.
DMBI	This is a 8 bit wide template MB input port. The template MB input is processed in parallel with the arithmetic operation. Therefore, the data inputted will be used in the next execution cycle.
DOUT	This is an 8 bit wide output port, during the field or frame mode, receives output request, OREQC, and outputs the following information in the following order. horizontal motion vector, vertical motion vector, minimum distortion, distortion of vector (0,0), half-pel indication code During the field dual-prime mode, the M65727 outputs minimum distortion and dmv indication code. During the frame dual-prime mode, it outputs minimum distortion, dmv indication code and distortions correspond to all estimation points.

2.2.2 System Control Pins

CLKI	Clock input.
RESETC	RESET pin. Hardware reset. Asserted low. Not all registers are reset by RESET. Before the normal operation, the M65727 requires RESET.
CEC	Asserted low. This pin enables the input clock. This signal is sampled at up-edge of CLKI. The next clock cycle is valid when this signal is asserted. The invalid clock cycle is called "wait cycle". The chip is designed as static CMOS circuits and the internal data will not be destroyed during wait cycles.
DENSWC	This pin enables DSWI port. This signal is asserted low. Data is not accepted during not-active cycles.
DENMBC	This pin enables DMBI port. This signal is asserted low. Data is not accepted during not-active cycles.
OEC	This is the output enable pin. It controls the tri-state of DOUT port. DOUT port. This signal is asserted low.

2.2.3 Sync Signal Input Pins

SSYNC	This is a sync signal for the DSWI port. It is asserted low. This signal must be asserted when the leading data for DSWI is inputted
MSYNC	This is a sync signal for the DMBI port. It is asserted low. This signal must be asserted when the leading data for DMBI is inputted
ESYNC	This is a sync signal for the block level pipeline. When this signal is asserted, one execution cycle (550 / 806 cycles) is activated. It is asserted low.
DSYNC	This is a sync signal for the DCNT port. It must be asserted when dynamic control signal is inputted. See DCNT for the content of the dynamic control signal. This signal is asserted low.
OREQC	This is used to request output. M65727 starts output from DOUT port after this signal is asserted. This signal is asserted low.

2.2.4 Pins Specifying Operational Modes

MODE	This pin sets the mode of the M65727. The following four modes can be specified. 00: Field mode, 01: Frame mode, 10: Field Dual-Prime mode, 11: Frame Dual-Prime mode
HSIZE	This pin specifies the horizontal search range. The following five types of range can be specified. 000: ± 7.5 , 001: ± 15.5 , 010: ± 31.5 , 011: ± 63.5 , 100: ± 127.5 , 101~ 111: reserved
VSIZE	This pin specifies the vertical search range. The following two types of range can be specified. 0: ± 7.5 , 1: ± 15.5
EXTND	This pin specifies the vertical search range expansion. When expansion modes are selected, the vertical search range is set to ± 8.0 / ± 16.0 . It is possible to expand a vertical search range using multiple chips. Depending on modes, the order of priority regarding the vectors with same distortions is different. 00: non-expansion, 01: reserved, 10: upper-range of expansion, 11: lower-range of expansion
HLFPL	This switches between half-pel precision search mode and integer-pel precision search mode. 0: Integer-pel precision search, 1: half-pel precision search
FMFMT	Switches between the external memory (SW image) formats. 0: Field format, 1: Frame format
DCNT	This is a dynamic control input. (Dynamic control means the control which differs in each execution cycle.) The following is required. Control of valid or invalid for search range (SKILL) Leading pixel location of search window image in the vertical direction when the dual-prime mode (DVSP0) The central position of the search window image used for the dual-prime mode (DCNTR)

	The above control signals are inputted within one execution cycle in the prearranged sequence by assuming DSYNC repeatedly. The control information are used at the next execution cycle.
--	---

2.2.5 Others

TEST	Used for testing the M65727 and is not released to users.
VDD	Power supply pin
GND	Grounding pin

3. Outline of Functions

3.1 Outline

M65727 is configured as shown in Fig. 3.11. Its main components are the Input Unit, the Integer-pel Unit, the Motion detection Unit, the Half-pel / Dual-Prime Unit, and the Output Unit. When the Field/Frame mode is selected, the search window image data and template MB data are inputted to the Input Unit from their respective input ports. The data is used as the source data of the Integer-pel Unit after its order is changed. Then, the mean absolute error is calculated for each cycle at the Integer-pel Unit and the result is given to the Motion detection Unit and the best integer-pel precision motion vectors are estimated. Then, at the Half-pel Unit, the best half-pel precision motion vectors are estimated. The results are output from the Output Unit. When the Field/Frame Dual-Prime mode is selected, the template MB data and the search window image data of the first field and the second field are sent to the Input Unit from their respective input ports and become the source data of the Dual-Prime Unit. Then, the motion vector estimation is conducted at the Dual-Prime Unit and the results are output from the Output Unit. The functions of each unit are outlined below.

3.2 Block Configuration

3.2.1 Input Unit

The function of Input Unit is to output the search window image data and the template MB data to the Integer-pel Unit or Dual-Prime Unit with the necessary sequence and timing.

Having this block enables the user to input comparatively freely the needed search window image data, using the sync signal (SSYNC) and the data enable signal (DENS WC), without regard to the motion estimation sequence. Similarly, necessary template MB data can be inputted fairly freely using the sync signal (MSYNC) and the data enable signal (DENMBC).

The search window image data is inputted from the highest line towards the lowest line scanning left to right. The output sequence, on the other hand, starts from the leftmost column to the rightmost column and scans top to bottom. The input and output sequence of the search window image data for Dual-Prime are from the highest line to the lowest line and scanning from left to right. The search window image data is inputted as 4 vertical continuous pixels using the 32 bit input port. The Input Unit outputs a pixel per cycle by parallel-serial conversion.

3.2.2 Integer-pel Unit

The function of this block is to calculate the mean absolute error using the template MB data and the search window image data coming from the Input Unit. The Integer-pel Unit is composed of processing elements arranged in parallel, allowing high speed processing of the data to be evaluated. Three sets of calculated mean absolute error (corresponding to 16x16 block and two sets of 16x8 block) are given to the Motion detection Unit. Three sets of search window image data and the template MB data that correspond to the three sets of vectors are transferred from the integer-pel Unit to the Half-pel Unit.

3.2.3 Motion detection Unit

The function of this block is to select the best motion vector of the integer-pel precision by comparing the 16-bit mean absolute error coming from the Integer-pel Unit. In addition, this block stores distortion of vector (0,0). In case when the distortions for multiple motion vectors are same, the most suitable motion vector is determined according to the order of priority.

The output data depends on the modes. When the integer-pel precision search mode is specified during the Field/Frame mode, the following items are output to the Output Unit. They are three sets of best integer-pel precision motion vectors, the distortion for each, and the distortion for each vector (0,0). If the half-pel precision search mode is specified when the Field/Frame mode, the three sets of best integer-pel precision motion vectors and the distortion for each vector (0,0) are output to the Output Unit. And, the distortions for each integer-pel precision vector are output to Half-pel Unit.

3.2.4 Half-Pel / Dual-Prime Unit

This Unit calculates, during the Field/Frame mode, the mean absolute errors for half-pel precision vectors and detects the minimum distortions using the partial search window image data around best integer-pel precision vectors.

The search window image consists of 18x18 pixels and two sets of 18x10 pixels around the three sets of integer-pel precision motion vectors detected at the Motion detection Unit. Eight kinds of interpolated images are generated by the half-pel interpolation filter. This image is matched against the template MB data given from the integer-pel Unit and the minimum distortions are detected from the above results.

During the Field/Frame Dual-Prime mode, it detects the best dmV from the template MB data, the first search window image data and the second search window image data.

The first and second search window image consist of 18x18 pixel (10) each. The interpolated image from the first search window is generated according to the central position information (Displacement based on 0.5 pixel from 16x16 (8) pixels contained in 18x18 (10) pixels). Similarly, nine sets of interpolated images are generated through the interpolated filter from the second search window. Then, the nine sets of averaging images of the first and the second images are obtained. Next, the block matching between the template MB data is conducted and the best dmV is obtained. In case of the Frame Dual-Prime mode, not only the minimum evaluation value, but all the evaluated values for all the displacement are output.

3.2.5 Output Unit

This is the interface circuit related to the Output Port, DOUT. Necessary data comes from the Motion detection Unit and Half-pel / Dual-Prime Unit and is output to through DOUT in sync with the output request signal, OREQC.

3.3 Operational Modes

M65727 has the following operational modes which can be switched externally. This chapter outlines the operational modes of M65727.

3.3.1 Field / Frame / Field Dual-Prime / Frame Dual-Prime

M65727 is capable of 4 modes, namely Field mode / Frame mode / Field Dual-Prime mode / Frame Dual-Prime mode, to work with the prediction mode of MPEG2. These modes are specified as shown below using MODE pins. They must be specified before the chip operation and fixed during operation.

- 00: Field mode
- 01: Frame mode
- 10: Field Dual-Prime mode
- 11: Frame Dual-Prime mode

Field mode detects three sets of motion vectors simultaneously which work with 16x16 block, 16x8 (upper) block, and 16x8 (lower) block.

Frame mode detects three sets of motion vectors simultaneously which work with 16x16 block, 16x8 (top) block, and 16x8 (bottom) block.

Field Dual-Prime and Frame Dual-Prime mode detect the dmV.

3.3.2 The Search Range in Horizontal Direction

The search range in the horizontal direction can be selected from ± 7.5 / ± 15.5 / ± 31.5 / ± 63.5 / and ± 127.5 . The number of cycles needed for the motion vector estimation increases in proportion to the size of the horizontal search range. When ± 15.5 or larger is specified as the horizontal search range, it is expected that multiple chips with interleaving manner are used. Refer to Chapter 5.5 for the number of chips needed when the horizontal search range is ± 15.5 or more. The horizontal search range is specified as shown below using HSIZE pins. The horizontal search range must be specified before the chip goes into operation and should be fixed during the operation.

- 000: ± 7.5 , 001: ± 15.5 , 010: ± 31.5 , 011: ± 63.5 , 100: ± 127.5 , 101 ~ 111: Reserved

3.3.3 The Search Range in Vertical Direction

The vertical search range can be selected from ± 7.5 and ± 15.5 . This range detects a minimum execution cycle (550 / 806). In the vertical expansion mode, the search range will be ± 8.0 / ± 16.0 . See Chapter 5.5 for the number of chips needed for the vertical expansion. The vertical search range is specified as shown below using VSIZE pin. This must be done before the chip operation and it should be fixed during the operation.

- 0: ± 7.5 , 1: ± 15.5

The vertical search range of ± 7.5 can be used only under 27MHz operation.

3.3.4 Search range expansion for Vertical direction

The non-expansion mode of vertical search range is $\pm 7.5 / \pm 15.5$ as explained above. At this time, the order of priority for vectors, which have same distortions, gives the highest priority to the vector (0,0). When the search range expansion mode of the vertical direction is specified, the range becomes $\pm 8.0 / 16.0$. It becomes possible to expand the vertical search range using multiple chips. There are two modes for vertical expansion mode, upper-range of expansion and lower-range of expansion. The difference between the two is in the priority order for distortion equivalent vectors. If it is specified as upper-range, the vector (0, +8 / +16) will have the highest priority. If it is specified as lower-range, the vector (0, -8 / -16) will have the highest priority. See Ch. 5.2 for the order of priority for vectors.

See Ch. 5.5 for the number of chips needed for the vertical search range expansion.

This mode is specified by EXTND pin as shown below. This mode must be specified before the chip goes into operation and it should be fixed during the operation.

00: non-expansion, 01: reserved, 10: upper-range of expansion (Expansion),
11: lower-range of expansion (Expansion)

3.3.5 Half-Pel Precision/Integer-Pel Precision

The motion vector searched by M65727 is integer-pel precision during the integer-pel precision mode. In case of half-pel precision mode, half-pel precision vector is detected using interpolated search window image. The order of output data is shown in Table 2 (See Ch. 3.3.7). The above two modes have different outputs.

This mode is specified by HLFPL pin as shown below. This mode should be specified before the chip operation and should stay fixed.

0: Integer-Pel Precision mode, 1: Half-Pel Precision mode

3.3.6 External Frame Memory Data Format

M65727 is capable of selecting the external frame memory (SW image) format only when the Frame mode is ON. This format is specified by the use of FMFMT pin as shown below. In other modes, only field format can be used. See Ch. 5.4 for details on formats. This mode must be specified prior to the chip operation and should be fixed during the operation.

0: Field format 1: Frame format

3.3.7 Operation Modes and Output Data

Data output from M65727 differs according to the operational modes. During the Field / Frame mode, three sets of data group, a group of 16x16 and two groups of 16x8, are output in sequence. Outputs from half-pel precision mode and integer precision search mode are different.

When the Field mode is ON, a data group for 16x16 block is first output. A data group for 16x8 (upper) block is output next and a data group for 16x8 (lower) is output last. It takes 21 cycles.

When the Frame mode is ON, a data group for 16x16 block is output first. A data group for 16x8 (top) is output next. And a 16x8 (bottom) block is output last. It takes 21 cycles.

Table 2 shows a set of data outputs during the Field/Frame mode in the order they are output.

In case of the Field Dual-Prime mode, Dual-Prime vector specifying code and its distortion are output in the order shown in Table 3. It takes 3 cycles to output data.

When the Frame Dual-Prime mode is used, the Dual-Prime vector specifying code, its distortion, and distortions for each displacement point are output in the order shown in Table 4. It takes 21 cycles to output data.

The integer-pel precision motion vector outputs as motion vector corresponding to 16x16 block even for 16x8 block. Therefore, during the Frame Estimation Mode, the vertical component of the motion vector for the 16x8 block must be changed outside.

When multiple chips are used to expand the vertical search range, the vertical components of the motion vectors must be changed for all blocks.

Fig. 3.3.7-1 shows correspondence between 16x8 block and vectors.

Table 2

Operational modes	Integer-pel precision search	Half-pel precision search
Output sequence 1	Motion vector horizontal component	Integer precision motion vector horizontal component
2	Motion vector vertical component	Integer precision motion vector vertical component
3	Minimum evaluation value (upper 8bits)	Minimum evaluation value (upper 8bits)
4	Minimum evaluation value (lower 8bits)	Minimum evaluation value (lower 8bits)
5	(0, 0) evaluation value (upper 8bits)	(0, 0) evaluation value (upper 8bits)
6	(0, 0) evaluation value (lower 8bits)	(0, 0) evaluation value (lower 8bits)
7	all 0 (L) output	Half-pel indication code

Note 1: The motion vector is a binary number in 2's complement. It is output after it is expanded to 8 bits.

Note 2: Upper 8 bits of the evaluation value is first output and the lower 8 bits are output next in natural binary

Note 3: Half-pel indication code is specified by the lower 4 bits as shown below. The upper 4 bits are for L output.

0000:	Most suitable for integer-pel precision motion vector	(0.0, 0.0)
1010:	Upper-left direction Half-pel of integer-pel precision vector	(-0.5, -0.5)
1001:	Upper-right direction Half-pel of integer-pel precision vector	(+0.5, -0.5)
0110:	Lower-left direction Half-pel of integer-pel precision vector	(-0.5, +0.5)
0101:	Lower-right direction Half-pel of integer-pel precision vector	(+0.5, +0.5)
0010:	Left direction Half-pel of integer-pel precision vector	(-0.5, +0.0)
0001:	Right direction Half-pel of integer-pel precision vector	(+0.5, +0.0)
1000:	Upper direction Half-pel of integer-pel precision vector	(+0.0, -0.5)
0100:	Lower direction Half-pel of integer-pel precision vector	(+0.0, +0.5)

Note 4: The (0,0) evaluation value is an evaluation value corresponding to the no-motion. When specifying the upper range of expansion, the evaluation point of (X, Y) = (0, +8 / +16) is used as the position; when specifying the lower range of expansion, the evaluation point of (X, Y) = (0, -8 / -16) is used as the position.

Table 3 Relationship between Field Dual-Prime Estimation Mode and Its Output Data

Output sequence 1	Minimum evaluation value (Upper 8bits)
2	Minimum evaluation value (Lower 8bits)
3	dmv indication code

Table 4 Relationship between Frame Dual-Prime Estimation Mode and Its Output Data

Output sequence 1	Minimum evaluation value (Upper)	Output sequence 12	Left evaluation value (Upper)
2	Minimum evaluation value (Lower)	13	Left evaluation value (Lower)
3	dmv indication code	14	Right evaluation value (Upper)
4	Center evaluation value (Upper)	15	Right evaluation value (Lower)
5	Center evaluation value (Lower)	16	Left lower evaluation value (Upper)
6	Left upper evaluation value (Upper)	17	Left lower evaluation value (Lower)
7	Left upper evaluation value (Lower)	18	Lower evaluation value (Upper)
8	Upper evaluation value (Upper)	19	Lower evaluation value (Lower)
9	Upper evaluation value (Lower)	20	Lower right evaluation value (Upper)
10	Right upper evaluation value (Upper)	21	Lower right evaluation value (Lower)
11	Right upper evaluation value (Lower)		

Note 1: The evaluated values are output using the natural binary number. First, the upper 8 bits are output and the lower 8 bits are output next.

Note 2: The dmv indication code is specified using the lower 4 bits as shown below. The upper 4 bits are for L output.

0000:	The center point vector is optimum	(+0.0, +0.0)
1010:	Upper left from the center point vector	(-0.5, -0.5)
1001:	Upper right from the center point vector	(+0.5, -0.5)
0110:	Lower left from the center point vector	(-0.5, +0.5)
0101:	Lower right from the center point vector	(+0.5, +0.5)
0010:	Left of the center point vector	(-0.5, +0.0)
0001:	Right of the center point vector	(+0.5, +0.0)
1000:	Upper direction from the center point vector	(+0.0, -0.5)
0100:	Lower direction from the center point vector	(+0.0, +0.5)

3.3.8 Operational Modes and Dynamic Control Signals (for each processing cycle)

M65727 has controls which need to change every execution cycle. These controls differ according to operational modes as shown below. They are input to the chip through DCNT pins when DSYNC is asserted. One assertion is needed for each information write into the chip. Therefore, when a mode needs multiple control information, DSYNC must be asserted multiple times. DSYNC is asserted low.

***Valid / Invalid control of search range (Search Window Kill: SKILL)**

This is used for Field/Frame/Field Dual-Prime/Frame Dual-Prime modes and shows whether they are valid or invalid with regard to the motion estimation range during the next execution cycle. When the horizontal search range is ± 15.5 or more, it is necessary to give valid/invalid information for the search range multiple times within a 1MB processing time (1 processing cycle = 2,4,8 or 16 x (550/806 cycles)). The range of vector which is invalidated by the SKILL differs according to modes (Field, Frame, Dual-Prime, horizontal search range, etc.).

See Ch. 5.1 for detail on the search invalidation control.

DCNT is assigned as follows:

DCNT [3]:	Upper direction is invalid	0: Valid	1: Invalid (Search top end)
DCNT [2]:	Lower direction is invalid	0: Valid	1: Invalid (Search bottom end)
DCNT [1]:	Left direction is invalid	0: Valid	1: Invalid (Search left end)
DCNT [0]:	Right direction is invalid	0: Valid	1: Invalid (Search right end)

***Position of leading image in vertical direction for the first search window data for Dual-Prime (DVSP01)**

This is used for Field/Frame Dual-Prime mode. The DVSP01 indicates the first pixel in the 32 bit word for the first search window data. As far as the timing for entering the above controls, they are input during the same execution cycle when the first search window is input and is used during the next execution cycle.

DCNT is assigned as follows:

DCNT [3:0]	0000: The leading pixel is at DSWI [31:24]
DCNT [3:0]	0001: The leading pixel is at DSWI [23:16]
DCNT [3:0]	0010: The leading pixel is at DSWI [15:8]
DCNT [3:0]	0011: The leading pixel is at DSWI [7:0]

***Position of leading image in vertical direction for the second search window data for Dual-Prime (DVSP02)**

This is used for Field/Frame Dual-Prime mode. The DVSP02 indicates the first pixel in the 32 bit word for the first search window data. As far as the timing for entering the above controls, they are input during the same execution cycle when the first search window is input and is used during the next execution cycle.

DCNT is assigned as follows:

DCNT [3:0]	0000: The leading pixel is at DSWI [31:24]
DCNT [3:0]	0001: The leading pixel is at DSWI [23:16]
DCNT [3:0]	0010: The leading pixel is at DSWI [15:8]
DCNT [3:0]	0011: The leading pixel is at DSWI [7: 0]

***The center position of the first search window data for Dual-Prime (DCNTR1)**

This setting is used for the Field/Frame Dual-Prime mode. It indicates the center position of the first search window data used for Dual-Prime (0.5 pixel unit displacement from 16x16 position within 18x18(10) field data). It is input at the same time when the first search window image is input and is used for calculation of the next execution cycle.

DCNT is assigned as follows:

DCNT [3:0]	0000: No displacement	(+0.0, +0.0)
DCNT [3:0]	1010: Upper left direction	(-0.5, -0.5)
DCNT [3:0]	1001: Upper right direction	(+0.5, -0.5)
DCNT [3:0]	0110: Lower left direction	(-0.5, +0.5)
DCNT [3:0]	0101: Lower right direction	(+0.5, +0.5)
DCNT [3:0]	0010: Left direction	(-0.5, +0.0)
DCNT [3:0]	0001: Right direction	(+0.5, +0.0)
DCNT [3:0]	1000: Upper direction	(+0.0, -0.5)
DCNT [3:0]	0100: Lower direction	(+0.0, +0.5)

*** The center position of the second search window data for Dual-Prime (DCNTR2)**

This setting is used for the Field/Frame Dual-Prime mode. It indicates the center position of the second search window data used for Dual-Prime (0.5 pixel unit displacement from 16x16 position within 18x18(10) field data). It is input at the same time when the first search window image is input and is used for calculation of the next execution cycle.

DCNT is assigned as follows:

DCNT [3:0]	0000: No displacement	(+0.0, +0.0)
DCNT [3:0]	1010: Upper left direction	(-0.5, -0.5)
DCNT [3:0]	1001: Upper right direction	(+0.5, -0.5)
DCNT [3:0]	0110: Lower left direction	(-0.5, +0.5)
DCNT [3:0]	0101: Lower right direction	(+0.5, +0.5)
DCNT [3:0]	0010: Left direction	(-0.5, +0.0)
DCNT [3:0]	0001: Right direction	(+0.5, +0.0)
DCNT [3:0]	1000: Upper direction	(+0.0, -0.5)
DCNT [3:0]	0100: Lower direction	(+0.0, +0.5)

***The sequence of dynamic control inputs when Field/Frame Dual-Prime mode is used**

The dynamic control information is input in the following sequence when Field/Frame Dual-Prime mode is used.

- (1) Valid/invalid control of search range (SKILL)
- (2) Leading pixel position for first search window data (DVSP01)
- (3) Leading pixel position for second search window data (DVSP02)
- (4) The center position of the first search window data (DCNTR1)
- (5) The center position of the first search window data (DCNTR2)

4. Operations

4.1 Reset Operation

When the RESET request signal (RESETC) is asserted to logical "L", M65727 goes into RESET cycle. This RESET cycle continues for two cycles after the RESET request signal is negated. It is a synchronized reset. It is sampled when the clock rises. It is prohibited to do activation for normal operation during the RESET cycle.

When using M65727, it is necessary to execute this RESET operation before starting normal operation. The RESETC signal must be asserted over two cycles. In addition, there should be at least 10 cycle space before the ESYNC is asserted in order to start normal operation.

Fig. 4.1-1 shows the RESET operation.

4.2 WAIT Operation

M65727 goes into WAIT cycle and stops the next cycle when the clock enable signal(CEC) is negated to logical "H". The values of registers in M65727 are held so that operations will be able to resume when the clock enable signal is asserted. The clock enable signal is sampled when the clock rises.

Fig. 4.2-1 shows the WAIT operation.

4.3 Motion Detection Operation

In order to activate the motion estimation operation, which is a normal M65727 operation, it is necessary, during the Field/frame mode, to input the search window image data, template MB data, and the dynamic control input, in addition requesting the output and activating the execution cycle. In case of the Field/Frame Dual-Prime mode, it is necessary to input the search window image data, input template MB data, request output, activate processing cycle, and input dynamic control. Each operation will be explained below.

4.3.1 Search Window Image Input for Field/Frame mode

The data input to M65727 during Field/Frame mode are the search window image data and the template MB data. The search window image input can be performed in parallel with and independent of the motion estimation operation. The search window image input starts at the cycle proceeding the cycle where the sync signal SSYNC is asserted. When the vertical search range of ± 7.5 is used, DENSWC must be asserted for 128 cycles during the data input. When the vertical search range of ± 15.5 is used, DENSWC must be asserted for 192 cycles. The valid cycle refers to the cycle whose input data is specified as valid by the data enable specifying signal, DENSWC, of the search window port. Specifying this data enable allows no wait data transfer using the faster frame memory (SRAM). For lower cost implementation when DRAM is used as frame memory, wait states are useful to allow slower data transfer.

Search window image is input in the order of raster scan starting from upper left of the screen. Four vertical adjacent pixels are input simultaneously using 32 bit DSWI.

The data input must be completed within one execution cycle and at least 10 cycles or more space is needed between ESYNC and SSYNC. As long as this limitation is obeyed, the search window image input can be performed in parallel with the input of the template MB data and the actual arithmetic operation of the motion estimation.

Fig. 4.3.1-1 shows the input operation of the search window image.

4.3.2 Search Window Image Input for Dual-Prime mode

The search window image for Dual-Prime can be input in parallel and independent of motion estimation operation. The search window image input for Dual-Prime starts at the cycle proceeding the cycle in which the sync signal SSYNC is asserted. The M65727 uses 108 valid cycles for the first search window when the Field Dual-Prime mode is ON. After the first search window is complete the SSYNC is asserted to begin the input of the second search window.

When the Frame Dual-Prime estimation Mode is used, there will be 72 valid cycles for the first search window, also 72 valid cycles for second search window. The valid cycle means the cycle whose input data is specified as valid by DENSWC.

The search window image input data used for Dual-Prime is input in the order according to the raster scan starting from the upper left of the screen. Four vertical adjacent pixels are input simultaneously using 32 bit DSWI.

The data input must be completed within one execution cycle and at least 10 cycles or more space is needed between ESYNC and SSYNC. As long as this limitation is obeyed, the search window image input for Dual-Prime can be run in parallel with the input of the template MB data and the actual operation of the motion estimation.

Fig. 4.3.2-1 shows the search window image data input operation used for Dual-Prime.

4.3.3 Template MB Data Input

Inputting the template MB data can be performed independent of and in parallel with the motion estimation operation. Excluding Frame Dual-Prime mode, the template MB data of M65727 requires 256 pixels per 1 macro block. In case of Frame Dual-Prime Estimation Mode, template MB includes 128 pixels, but, 256 pixels (of which the last 128 pixels are dummy pixels) are needed. Inputting the template MB data starts at the cycle proceeding the cycle in which the sync signal MSYNC is asserted and continues for 256 valid cycles. The valid cycle refers to the cycle whose input data is specified as valid by the data enable specifying signal, DENMBC. It is possible, using this data enable specification, to do no wait data transfer using SRAM as frame memory. For lower cost implementation when DRAM is used as frame memory, wait states are useful to allow slower data transfer.

The template MB data is input by scanning from the upper left-hand corner in vertical direction. The data input must be completed within one execution cycle and at least 10 cycles or more space is needed between ESYNC and MSYNC. As long as this limitation is obeyed, the template MB input can be run in parallel with the actual arithmetic operation of motion estimation and the search window image input.

Fig. 4.3.3-1 shows the input operation of the template MB data.

4.3.4 Output Request

M65727 is capable of outputting the result of operation independently and in parallel with the arithmetic operation of the motion estimation. The output data is output by asserting OREQC, the output request signal.

The output data becomes invalid when the RESET cycle occurs before during the motion estimation operation, or when ESYNC signal is asserted with the space less than the minimum number of execution cycle (550 / 806 cycles) before the output data becomes valid. Moreover, the space between ESYNC and OREQC must be at least 30 cycles.

The output port uses tri-state output. This is activated by asserting OEC, the output enable signal.

Fig. 4.3.4-1 shows the output operation.

4.3.5 Activation of Execution Cycle

The execution cycle of M65727 is activated by ESYNC, the execution sync signal. The minimum number of cycles for one execution cycle depends on the vertical search range. When the vertical search range is ± 7.5 , 550 is required. When it is ± 15.5 , 806 is required. It is necessary to assert ESYNC using an interval greater than the above minimum cycle.

It is necessary to input the search window image data, the template MB data, and the dynamic control information within the execution cycle activated by one SYNC signal. It is not allowed to input the above across ESYNC's.

Fig. 4.3.5-1 shows how the execution cycle is activated.

4.3.6 Dynamic Control Input

M65727 allows the control information to be input independent of and parallel to the arithmetic operation of the motion estimation. The dynamic control information is input by repeated assertion of DSYNC

The control data input must be completed within one execution cycle and at least 10 cycles or more space is needed between ESYNC and DSYNC. As long as this limitation is obeyed, the dynamic control information can be input in parallel with the search window image data and the actual operation of the motion estimation operation.

Fig. 4.3.6-1 shows the dynamic control input operation.

4.3.7 Number of Cycles Needed (from Data Input to Data Output)

The number of cycles needed depends on the operating modes. The minimum number of cycles needed for one execution cycle (from the assertion of one ESYNC to the assertion of next ESYNC) depends on the vertical search range. When the vertical search range is ± 7.5 , 550 cycles are needed; when it is ± 15.5 , 806 cycles are needed. When the Field/Frame Dual-Prime mode is used, the minimum cycles will be 550 cycles.

The number of cycles needed for various modes is shown below.

- | | |
|---|-----------------------|
| (1) Field/Frame mode, horizontal search range ± 7.5 : | 5 x execution cycles |
| (2) Field/Frame mode, horizontal search range ± 15.5 : | 6 x execution cycles |
| (3) Field/Frame mode, horizontal search range ± 31.5 : | 8 x execution cycles |
| (4) Field/Frame mode, horizontal search range ± 63.5 : | 12 x execution cycles |
| (5) Field/Frame mode, horizontal search range ± 127.5 : | 20 x execution cycles |
| (6) Field Dual-Prime mode: | 3 x execution cycles |
| (7) Frame Dual-Prime mode: | 3 x execution cycles |

5. Others

5.1 Macro Block Processing for Missing Search Range

M65727 conducts special processing when there is some missing search range in the macro block being processed or when a portion of the search range needs making invalid. M65727 requires to indicate, for each execution cycle, whether the range being searched is valid or invalid from outside. The information concerning whether the range being searched is valid or invalid (SKILL) is input to the chip from DCNT pin when DSYNC is asserted. However, the meaning of valid and invalid given by SKILL information differs according to modes.

*SKILL Information for Field/Field mode

In case when SKILL information indicates that the upper direction of the search range is invalid (Search Top), M65727 invalidate the following vectors.

[integer-pel precision vector]

The vector, whose vertical component is negative, is invalidated.

[half-pel precision vector]

When the vector, whose vertical component is zero, is selected as best integer-pel precision vector, the half-pel vector, whose vertical component is negative, is invalidated.

If SKILL information specifies that the down direction of the search range is invalid (Search Bottom), M65727 invalidates the following vectors.

[integer-pel precision vector]

The vector, whose vertical component is positive, is invalidated.

[half-pel precision vector]

When the vector, whose vertical component is zero, is selected as best integer-pel precision vector, the half-pel vector, whose vertical component is positive, is invalidated.

If SKILL information specifies that both top and bottom directions of a search range are invalid at the same time, (Search Top and Bottom), M65727 invalidates the following vectors.

[integer-pel precision vector]

The vector, whose vertical component is positive or negative, is invalidated.

[half-pel precision vector]

The half-pel vector, whose vertical component is positive or negative, is invalidated. As a result, the selected motion vector has a zero as a vertical component.

When the left direction among the search range is specified as invalid (Search Left) by SKILL information when the horizontal search range is ± 7.5 , M65727 invalidates the following vectors.

[integer-pel precision vector]

The vector, whose horizontal component is negative, is invalidated.

[half-pel precision vector]

When the vector, whose horizontal component is zero, is selected as best integer-pel precision vector, the half-pel vector, whose horizontal component is negative, is invalidated.

In case when SKILL information specifies the right direction among the search range is invalid (Search Right) when the horizontal search range is ± 7.5 , M65727 invalidates the following vectors.

[integer-pel precision vector]

The vector, whose horizontal component is positive, is invalidated.

[half-pel precision vector]

When the vector, whose horizontal component is zero, is selected as best integer-pel precision vector, the half-pel vector, whose horizontal component is positive, is invalidated.

Moreover, if both left and right directions among the search range are made invalid at the same time by SKILL information (Search Left and Right) when the horizontal search range is ± 7.5 , M65727 invalidates the following vectors.

[integer-pel precision vector]

The vector, whose horizontal component is positive or negative, is invalidated.

[half-pel precision vector]

The half-pel vector, whose horizontal component is positive or negative, is invalidated. As a result, the selected motion vector has a zero as a horizontal component. Therefore, if search top, search down, search left, and search right are specified at the same time during the horizontal search range is ± 7.5 , only (0, 0) vector can be selected.

When using ± 15.5 or more as the horizontal search range, if SKILL information specifies that the left direction among the search range is invalid (Search Left), M65727 invalidates the following vectors.

[integer-pel precision vector]

No vector is invalidated.

[half-pel precision vector]

When the vector, whose horizontal position is most left in a search range of the current execution cycle, is selected as the best integer-pel precision vector, the half-pel vector, whose horizontal component is negative, is invalidated.

When SKILL information specifies that the right direction among the search range is invalid (search right) using ± 15.5 or more as the horizontal search range, M65727 invalidates the following vectors.

[integer-pel precision vector]

The vector, whose horizontal position isn't most left in a search range of the current execution cycle is invalidated.

[half-pel precision vector]

When the vector, whose horizontal position is most left in a search range of the current execution cycle, is selected as the best integer-pel precision vector, the half-pel vector, whose horizontal component is positive, is invalidated.

When the horizontal search range is ± 15.5 or more, it is prohibited to specify the search left and the search right at the same time except specifying all invalid (See below). When the horizontal search range is ± 15.5 or more, if all of the search range is made invalid (All invalid) (DCNT [3:0]: 1111) by SKILL information, M65727 will make all the motion vector of the said search range invalid. It is possible to limit the range by combining the above mentioned SKILL information.

***SKILL information used by Field/Frame Dual-Prime mode**

When the top direction of a search range is made invalid by SKILL information (Search Top), M65727 invalidates the Dual-Prime vector whose vertical component is negative. When the down direction among the search range is specified as invalid by SKILL information (Search Down), M65727 makes the Dual-Prime vector of the search range invalid if its vertical component is positive.

When the left direction among the search range is made invalid by SKILL information (Search Left), M65727 invalidates Dual-Prime vector of the search range if its horizontal component is negative. If SKILL information specifies that the right direction among the search range is invalid (Search Right), M65727 invalidates Dual-Prime vector of the search range whose horizontal component is positive.

5.2 Priority Order for Distortion Equivalent Vector

If there are multiple motion vectors which gives the minimum distortion, it is necessary to determine the final motion vector by giving them priority order. M65727 decided on the following priority order according to non-expansion / expansion upper range / expansion lower range.

***Priority order of the distortion equivalent vector for non-expansion**

During the non-expansion mode, the distortion equivalent vector has the priority order given by the following equation with Vector (0,0) as the highest priority location.

$$P(X, Y) = |X| + |Y| \quad \text{The smaller the value of } P(X, Y), \text{ the higher the priority.}$$

***Priority order of the distortion equivalent vector for expansion upper**

During the expansion upper range mode, the distortion equivalent vector uses Vector (0, +8/+16) location as the top priority and uses the priority order given by the following equation.

$$P(X, Y) = |X| + (-Y+16) \quad \text{The smaller the value of } P(X, Y), \text{ the higher the priority.}$$

*** Priority order of the distortion equivalent vector for expansion lower**

During the expansion lower range mode, the distortion equivalent vector uses Vector (0, -8/-16) location as the top priority and uses the priority order given by the following equation.

$$P(X, Y) = |X| + (Y+16) \quad \text{The smaller the value of } P(X,Y), \text{ the higher the priority.}$$

Each mode has vectors having the same priority. However, among them, if the motion vector in horizontal direction is close to negative infinity or the same, the side whose dynamic vector in vertical direction is closer to the negative infinity has the priority.

Fig. 5.2-1 shows the order of priority for the distortion equivalent vector.

5.3 Detail of Vector Search Range

In case of the non-expansion mode, the motion vector search range of M65727 is $\pm 7.5/\pm 15.5$ displacement in vertical direction. When integer precision search mode is specified, the search range is $\pm 7/\pm 15$.

When the integer precision search mode is specified, the horizontal search ranges become as follows:

$$\pm 15.5 \rightarrow \pm 15.0, \quad \pm 31.5 \rightarrow \pm 31.0, \quad \pm 63.5 \rightarrow \pm 63.0, \quad \pm 127.5 \rightarrow \pm 127.0$$

5.4 Formats for External Frame Memory (Search Window Image Memory)

The external frame memory (Search window image memory) used by M65727 has two formats. One is field format and the other is frame format. Field format indicates the state in which field images are stored in succession. One word (32 bits) stores 4 pixels lined up in succession vertically in one field. Frame format indicates that frame images are stored in succession. Within one word (32 bits), four continuous pixels are stored vertically within one frame. (Field pixels of different parity are alternately stored.) It is necessary that the boundary of 4 pixels stored in one word must agree with the boundary of macro block no matter which format is used.

The format for external frame memory depends on the mode as follows:

- *Field mode Field format only
- *Frame mode Field format or frame format
- *Field Dual-Prime mode Field format only
- *Frame Dual-Prime mode Field format only

5.5 Expansion of Search Range and Controlling the Validity of Search Range

One M65727 chip is capable of searching ± 7.5 pixels in horizontal direction and $\pm 7.5/\pm 15.5$ in vertical direction. Fig. 5.5-1 shows the controlling conditions necessary for one chip operation.

When the horizontal search range is expanded ($\pm 15.5 \sim \pm 127.5$), the following number of chips is needed.

- ± 15.5 : 2 chips
- ± 31.5 : 4 chips
- ± 63.5 : 8 chips
- ± 127.5 : 16 chips

Fig. 5.5-2 shows the conditions needed for the search range control when horizontal search range is expanded.

The number of chips needed for the expanded vertical search range ($\pm 16/\pm 32$ or more) is shown below. It is not allowed to use odd number of chips for expanded vertical search range.

When ± 7.5 is specified for one chip vertical search range,

± 16.0 :	2 chips
± 32.0 :	4 chips
± 64.0 :	8 chips

When ± 15.5 is specified for one chip vertical search range,

± 32.0 :	2 chips
± 64.0 :	4 chips
± 128.0 :	8 chips

Fig. 5.5-3 shows the conditions needed for the control of expanded vertical search range. Fig. 5.5-4 shows the relation between output vertical vector and real vertical vector.

When both horizontal and vertical ranges are expanded, the product of the number of chips needed for the above search ranges becomes the number of chips needed.

5.6 Operational Timing

Data (Control) sent to M65727 must be done within pre-determined execution cycles. If data (Control) I/O is performed during different execution cycles, operations of M65727 is not guaranteed.

Fig. 5.6-1 shows the operational timing of M65727.

5.7 Treatment of Final MB

The M65727 is designed so that it processes successive MB horizontally. So, the special treatment is required for final MB (when the horizontal search range expansion by multi-chip, each final MB processed in each M65727 requires special treatment).

The special treatment means that the user must input every control and data to M65727 as extra (dummy) successive MB will be processing until the out-put of final MB is finished.

5.8 Mode Change during Processing

The sequence of mode change during processing shows below.

- Finish the output of necessary MB in previous mode
- Change the operation mode by mode pins
- Reset the M65727
- Input control and data for new operation mode

6. Electrical Characteristics and Others

6.1 Electrical Characteristics

6.1.1 Maximum Ratings (Ta : 0°C to +70°C)

Parameters	Description	Test Condition	Value	Units
VDD	Supply Voltage		-0.3V to +4.0V	V
VI	Input Voltage		-0.3V to VDD+0.3V	V
VO	Output Voltage		-0.3V to VDD+0.3V	V
Pd	Power Dissipation	f = 27MHz	1.75W	W
Pd	Power Dissipation	f = 40.5MHz	2.1W	W
Topr	Operating Temperature		0°C to +70°C	°C
Tstg	Storage Temperature		-40°C to +125°C	°C

6.1.2 Operating Range (Ta : 0°C to +70°C)

Parameters	Description	Test Condition	Value			Units
			Min.	Typ.	Max.	
Vdd	Supply Voltage		3.15	3.3	3.45	V
Vss	Ground Voltage		-	0	-	V
VIH	Input HIGH Voltage	for CLKI	Vddx0.8		Vdd	V
		for Others	2.0		Vdd	V
VIL	Input LOW Voltage	for CLKI	0		Vddx0.2	V
		for Others	0		0.8	V

6.1.3 Electrical Characteristics (Vdd : 3.3±0.15V, Ta : 0°C to +70°C)

Max.	Description	Test Condition	Value			Units
			Min.	Typ.		
VOH	Output HIGH Voltage	IOL = -4mA	2.4		Vdd	V
VOL	Output LOW Voltage	IOH = +4mA	0		0.4	V
IIH	Input Leakage Current	VIH = Vdd-0.1V	-1		1	μA
IIL		VIL = Vss+0.1V	-1		1	μA
IOZH	Output OFF(Hi-Z) Current	VIH = Vdd-0.1V	-1		1	μA
IOZL		VIL = Vss+0.1V	-1		1	μA
ICCd	Supply Current (Operating)	f = 40.5MHz			600	mA
ICCs	Supply Current (Static)				2	mA

6.1.4 Switching Characteristics (Vdd : 3.3±0.15V, Ta : 0°C to +70°C)

Parameters	Description	Test Condition	Value			Units
			Min.	Typ.	Max.	
tPLH tPHL	Clock to Data Output				15	ns
tPLZ tPHZ	OEC Disable Time				10	ns
tPZL tPZH	OEC Enable Time				10	ns

6.1.5 Set-up and Hold Times (Vdd : 3.3±0.15V, Ta : 0°C to +70°C)

Parameters	Description	Test Condition	Value			Units
			Min.	Typ.	Max.	
tc(CLK)	Input Clock Cycle		24.6		38	ns
tr(CLK)	Clock Rise Time				5	ns
tf(CLK)	Clock Fall Time				5	ns
twh(CLK)	Clock HIGH Pulse Width		tc x 0.45		tc x 0.55	ns
twl(CLK)	Clock LOW Pulse Width		tc x 0.45		tc x 0.55	ns
tsu(D)	Data Set-up Time Relative to Clock		5			ns
th(D)	Data Hold Time Relative to Clock		5			ns
ts(C)	Control Set-up Time Relative to Clock		5			ns
th(C)	Control Hold Time Relative to Clock		5			ns

Fig. 6.1.5-1 shows the timing diagram of each parameter.

6.2 Package

The M65727 is housed in plastic 152-pin 28mm x 28mm body HQFP.

Fig. 6.2-1 shows an overview of the package, and fig. 6.2-2 and table 6.2-1 show the pin configuration.

6.3 Thermal Management

The M65727 is designed to operate at 27MHz and 40.5MHz. When 27MHz operation, no thermal management is required (The M65727 can operate in still air.). But, when 40.5MHz, some thermal management is required.

The required thermal management is as follows:

- Forced air cooling by 0.5m/s air
- Forced cooling by heat sink (for example: Aluminum table : 28mm x 28mm x 2mm)

Fig. 3.1-1 Overall Configuration of M65727

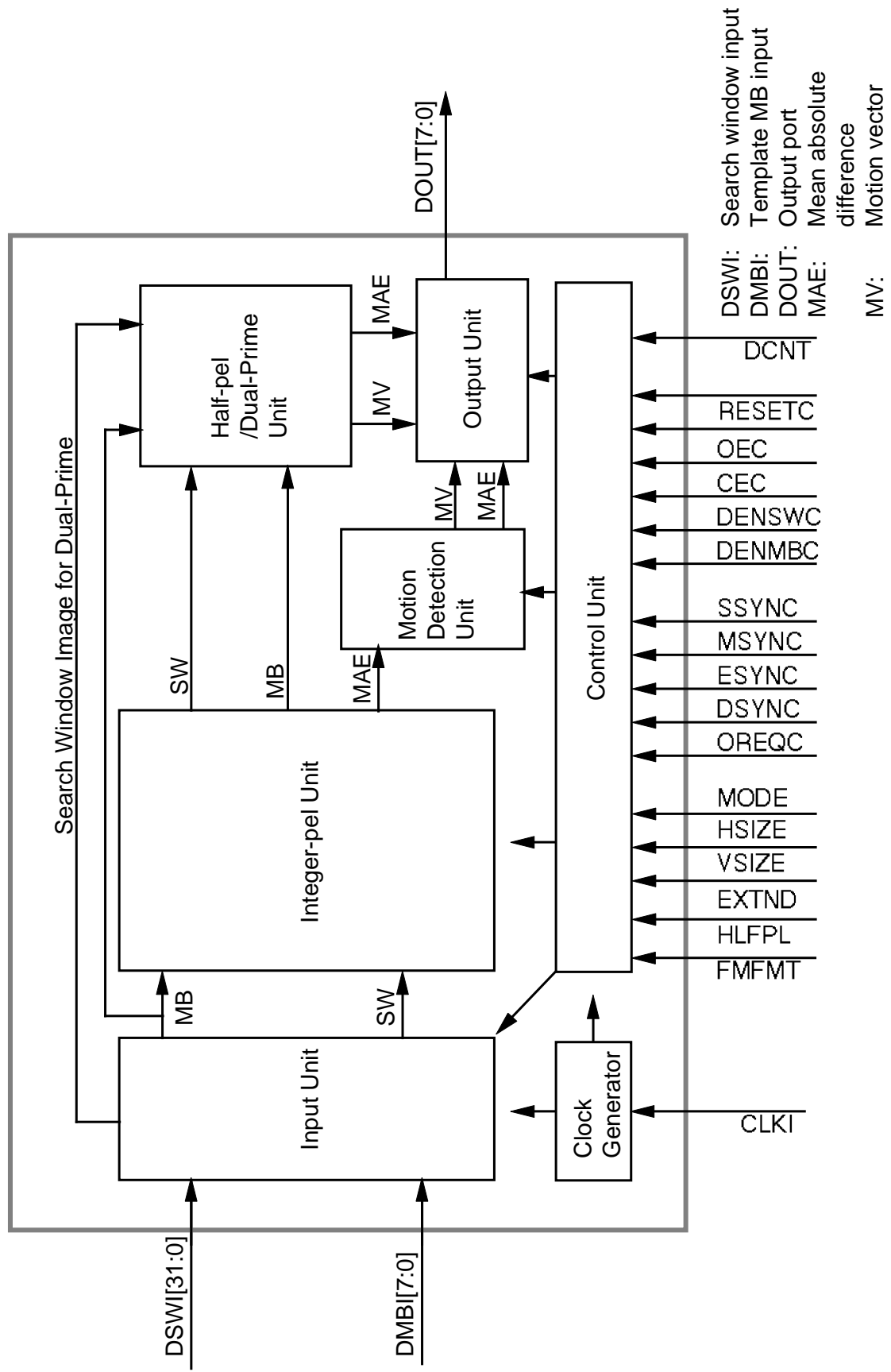

Fig. 3.3.7-1 Correspondence between blocks and vertical vector output

1chip ± 7.5

vector	16x16 MB	top MB	bottom MB
-8	-8	t_-4	b_-4
-7	-7	b_-4	t_-3
-6	-6	t_-3	b_-3
-5	-5	b_-3	t_-2
-4	-4	t_-2	b_-2
-3	-3	b_-2	t_-1
-2	-2	t_-1	b_-1
-1	-1	b_-1	t_0
0	0	t_0	b_0
1	1	b_0	t_+1
2	2	t_+1	b_+1
3	3	b_+1	t_+2
4	4	t_+2	b_+2
5	5	b_+2	t_+3
6	6	t_+3	b_+3
7	7	b_+3	t_+4
8	8	t_+4	b_+4

1chip ± 15.5

vector	16x16 MB	top MB	bottom MB
-16	-16	t_-8	b_-8
-15	-15	b_-8	t_-7
-14	-14	t_-7	b_-7
-13	-13	b_-7	t_-6
-12	-12	t_-6	b_-6
-11	-11	b_-6	t_-5
-10	-10	t_-5	b_-5
-9	-9	b_-5	t_-4
-8	-8	t_-4	b_-4
-7	-7	b_-4	t_-3
-6	-6	t_-3	b_-3
-5	-5	b_-3	t_-2
-4	-4	t_-2	b_-2
-3	-3	b_-2	t_-1
-2	-2	t_-1	b_-1
-1	-1	b_-1	t_0
0	0	t_0	b_0
1	1	b_0	t_+1
2	2	t_+1	b_+1
3	3	b_+1	t_+2
4	4	t_+2	b_+2
5	5	b_+2	t_+3
6	6	t_+3	b_+3
7	7	b_+3	t_+4
8	8	t_+4	b_+4
9	9	b_+4	t_+5
10	10	t_+5	b_+5
11	11	b_+5	t_+6
12	12	t_+6	b_+6
13	13	b_+6	t_+7
14	14	t_+7	b_+7
15	15	b_+7	t_+8
16	16	t_+8	b_+8

**Fig. 5.5-4c Correspondence between blocks and vertical vector output
(2 chips expansion when vertical search range is ± 15.5)**

2-chips ± 32.0

vector	ME#1			ME#2		
	16*16 MB	top MB	bottom MB	16*16 MB	top MB	bottom MB
-16	-32	t_-16	b_-16	0	t_0	b_0
-15	-31	b_-16	t_-15	1	b_0	t_+1
-14	-30	t_-15	b_-15	2	t_+1	b_+1
-13	-29	b_-15	t_-14	3	b_+1	t_+2
-12	-28	t_-14	b_-14	4	t_+2	b_+2
-11	-27	b_-14	t_-13	5	b_+2	t_+3
-10	-26	t_-13	b_-13	6	t_+3	b_+3
-9	-25	b_-13	t_-12	7	b_+3	t_+4
-8	-24	t_-12	b_-12	8	t_+4	b_+4
-7	-23	b_-12	t_-11	9	b_+4	t_+5
-6	-22	t_-11	b_-11	10	t_+5	b_+5
-5	-21	b_-11	t_-10	11	b_+5	t_+6
-4	-20	t_-10	b_-10	12	t_+6	b_+6
-3	-19	b_-10	t_-9	13	b_+6	t_+7
-2	-18	t_-9	b_-9	14	t_+7	b_+7
-1	-17	b_-9	t_-8	15	b_+7	t_+8
0	-16	t_-8	b_-8	16	t_+8	b_+8
1	-15	b_-8	t_-7	17	b_+8	t_+9
2	-14	t_-7	b_-7	18	t_+9	b_+9
3	-13	b_-7	t_-6	19	b_+9	t_+10
4	-12	t_-6	b_-6	20	t_+10	b_+10
5	-11	b_-6	t_-5	21	b_+10	t_+11
6	-10	t_-5	b_-5	22	t_+11	b_+11
7	-9	b_-5	t_-4	23	b_+11	t_+12
8	-8	t_-4	b_-4	24	t_+12	b_+12
9	-7	b_-4	t_-3	25	b_+12	t_+13
10	-6	t_-3	b_-3	26	t_+13	b_+13
11	-5	b_-3	t_-2	27	b_+13	t_+14
12	-4	t_-2	b_-2	28	t_+14	b_+14
13	-3	b_-2	t_-1	29	b_+14	t_+15
14	-2	t_-1	b_-1	30	t_+15	b_+15
15	-1	b_-1	t_0	31	b_+15	t_+16
16	0	t_0	b_0	32	t_+16	b_+16

**Fig. 5.5-4d Correspondence between blocks and vertical vector output
(4 chips expansion when vertical search range is ± 15.5)**

4-chips ± 64.0

vector	ME#1				ME#2				ME#3				ME#4			
	16*16 MB	top MB	bottom MB	16*16 MB	top MB	bottom MB	16*16 MB	top MB	bottom MB	16*16 MB	top MB	bottom MB	16*16 MB	top MB	bottom MB	
-16	-64	t_-32	b_-32	-32	t_-16	b_-16	0	t_0	b_0	32	t_+16	b_+16	32	t_+16	b_+16	
-15	-63	b_-32	t_-31	-31	b_-16	t_-15	1	b_0	t_+1	33	b_+16	t_+17	33	b_+16	t_+17	
-14	-62	t_-31	b_-31	-30	t_-15	b_-15	2	t_+1	b_+1	34	t_+17	b_+17	34	t_+17	b_+17	
-13	-61	b_-31	t_-30	-29	b_-15	t_-14	3	b_+1	t_+2	35	b_+17	t_+18	35	b_+17	t_+18	
-12	-60	t_-30	b_-30	-28	t_-14	b_-14	4	t_+2	b_+2	36	t_+18	b_+18	36	t_+18	b_+18	
-11	-59	b_-30	t_-29	-27	b_-14	t_-13	5	b_+2	t_+3	37	b_+18	t_+19	37	b_+18	t_+19	
-10	-58	t_-29	b_-29	-26	t_-13	b_-13	6	t_+3	b_+3	38	t_+19	b_+19	38	t_+19	b_+19	
-9	-57	b_-29	t_-28	-25	b_-13	t_-12	7	b_+3	t_+4	39	b_+19	t_+20	39	b_+19	t_+20	
-8	-56	t_-28	b_-28	-24	t_-12	b_-12	8	t_+4	b_+4	40	t_+20	b_+20	40	t_+20	b_+20	
-7	-55	b_-28	t_-27	-23	b_-12	t_-11	9	b_+4	t_+5	41	b_+20	t_+21	41	b_+20	t_+21	
-6	-54	t_-27	b_-27	-22	t_-11	b_-11	10	t_+5	b_+5	42	t_+21	b_+21	42	t_+21	b_+21	
-5	-53	b_-27	t_-26	-21	b_-11	t_-10	11	b_+5	t_+6	43	b_+21	t_+22	43	b_+21	t_+22	
-4	-52	t_-26	b_-26	-20	t_-10	b_-10	12	t_+6	b_+6	44	t_+22	b_+22	44	t_+22	b_+22	
-3	-51	b_-26	t_-25	-19	b_-10	t_-9	13	b_+6	t_+7	45	b_+22	t_+23	45	b_+22	t_+23	
-2	-50	t_-25	b_-25	-18	t_-9	b_-9	14	t_+7	b_+7	46	t_+23	b_+23	46	t_+23	b_+23	
-1	-49	b_-25	t_-24	-17	b_-9	t_-8	15	b_+7	t_+8	47	b_+23	t_+24	47	b_+23	t_+24	
0	-48	t_-24	b_-24	-16	t_-8	b_-8	16	t_+8	b_+8	48	t_+24	b_+24	48	t_+24	b_+24	
1	-47	b_-24	t_-23	-15	b_-8	t_-7	17	b_+8	t_+9	49	b_+24	t_+25	49	b_+24	t_+25	
2	-46	t_-23	b_-23	-14	t_-7	b_-7	18	t_+9	b_+9	50	t_+25	b_+25	50	t_+25	b_+25	
3	-45	b_-23	t_-22	-13	b_-7	t_-6	19	b_+9	t_+10	51	b_+25	t_+26	51	b_+25	t_+26	
4	-44	t_-22	b_-22	-12	t_-6	b_-6	20	t_+10	b_+10	52	t_+26	b_+26	52	t_+26	b_+26	
5	-43	b_-22	t_-21	-11	b_-6	t_-5	21	b_+10	t_+11	53	b_+26	t_+27	53	b_+26	t_+27	
6	-42	t_-21	b_-21	-10	t_-5	b_-5	22	t_+11	b_+11	53	t_+27	b_+27	53	t_+27	b_+27	
7	-41	b_-21	t_-20	-9	b_-5	t_-4	23	b_+11	t_+12	55	b_+27	t_+28	55	b_+27	t_+28	
8	-40	t_-20	b_-20	-8	t_-4	b_-4	24	t_+12	b_+12	56	t_+28	b_+28	56	t_+28	b_+28	
9	-39	b_-20	t_-19	-7	b_-4	t_-3	25	b_+12	t_+13	57	b_+28	t_+29	57	b_+28	t_+29	
10	-38	t_-19	b_-19	-6	t_-3	b_-3	26	t_+13	b_+13	58	t_+29	b_+29	58	t_+29	b_+29	
11	-37	b_-19	t_-18	-5	b_-3	t_-2	27	b_+13	t_+14	59	b_+29	t_+30	59	b_+29	t_+30	
12	-36	t_-18	b_-18	-4	t_-2	b_-2	28	t_+14	b_+14	60	t_+30	b_+30	60	t_+30	b_+30	
13	-35	b_-18	t_-17	-3	b_-2	t_-1	29	b_+14	t_+15	61	b_+30	t_+31	61	b_+30	t_+31	
14	-34	t_-17	b_-17	-2	t_-1	b_-1	30	t_+15	b_+15	62	t_+31	b_+31	62	t_+31	b_+31	
15	-33	b_-17	t_-16	-1	b_-1	t_0	31	b_+15	t_+16	63	b_+31	t_+32	63	b_+31	t_+32	
16	-32	t_-16	b_-16	0	t_0	b_0	32	t_+16	b_+16	64	t_+32	b_+32	64	t_+32	b_+32	

**Fig. 5.5-4a Correspondence between blocks and vertical vector output
(2 chips expansion when vertical search range is ± 7.5)**

2-chips ± 16.0

vector	ME#1			ME#2		
	16*16 MB	top MB	bottom MB	16*16 MB	top MB	bottom MB
-8	-16	t ₋₈	b ₋₈	0	t ₀	b ₀
-7	-15	b ₋₈	t ₋₇	1	b ₀	t ₊₁
-6	-14	t ₋₇	b ₋₇	2	t ₊₁	b ₊₁
-5	-13	b ₋₇	t ₋₆	3	b ₊₁	t ₊₂
-4	-12	t ₋₆	b ₋₆	4	t ₊₂	b ₊₂
-3	-11	b ₋₆	t ₋₅	5	b ₊₂	t ₊₃
-2	-10	t ₋₅	b ₋₅	6	t ₊₃	b ₊₃
-1	-9	b ₋₅	t ₋₄	7	b ₊₃	t ₊₄
0	-8	t ₋₄	b ₋₄	8	t ₊₄	b ₊₄
1	-7	b ₋₄	t ₋₃	9	b ₊₄	t ₊₅
2	-6	t ₋₃	b ₋₃	10	t ₊₅	b ₊₅
3	-5	b ₋₃	t ₋₂	11	b ₊₅	t ₊₆
4	-4	t ₋₂	b ₋₂	12	t ₊₆	b ₊₆
5	-3	b ₋₂	t ₋₁	13	b ₊₆	t ₊₇
6	-2	t ₋₁	b ₋₁	14	t ₊₇	b ₊₇
7	-1	b ₋₁	t ₀	15	b ₊₇	t ₊₈
8	0	t ₀	b ₀	16	t ₊₈	b ₊₈

**Fig. 5.5-4b Correspondence between blocks and vertical vector output
(4 chips expansion when vertical search range is ± 7.5)**

4-chips ± 32.0

vector	ME#1				ME#2				ME#3				ME#4			
	16*16 MB	top MB	bottom MB	16*16 MB	top MB	bottom MB	16*16 MB	top MB	bottom MB	16*16 MB	top MB	bottom MB	16*16 MB	top MB	bottom MB	
-8	-32	t ₋₁₆	b ₋₁₆	-16	t ₋₈	b ₋₈	0	t ₀	b ₀	16	t ₊₈	b ₊₈	16	t ₊₈	b ₊₈	
-7	-31	b ₋₁₆	t ₋₁₅	-15	b ₋₈	t ₋₇	1	b ₀	t ₊₁	17	b ₊₈	t ₊₉	17	b ₊₈	t ₊₉	
-6	-30	t ₋₁₅	b ₋₁₅	-14	t ₋₇	b ₋₇	2	t ₊₁	b ₊₁	18	t ₊₉	b ₊₉	18	t ₊₉	b ₊₉	
-5	-29	b ₋₁₅	t ₋₁₄	-13	b ₋₇	t ₋₆	3	b ₊₁	t ₊₂	19	b ₊₉	t ₊₁₀	19	b ₊₉	t ₊₁₀	
-4	-28	t ₋₁₄	b ₋₁₄	-12	t ₋₆	b ₋₆	4	t ₊₂	b ₊₂	20	t ₊₁₀	b ₊₁₀	20	t ₊₁₀	b ₊₁₀	
-3	-27	b ₋₁₄	t ₋₁₃	-11	b ₋₆	t ₋₅	5	b ₊₂	t ₊₃	21	b ₊₁₀	t ₊₁₁	21	b ₊₁₀	t ₊₁₁	
-2	-26	t ₋₁₃	b ₋₁₃	-10	t ₋₅	b ₋₅	6	t ₊₃	b ₊₃	22	t ₊₁₁	b ₊₁₁	22	t ₊₁₁	b ₊₁₁	
-1	-25	b ₋₁₃	t ₋₁₂	-9	b ₋₅	t ₋₄	7	b ₊₃	t ₊₄	23	b ₊₁₁	t ₊₁₂	23	b ₊₁₁	t ₊₁₂	
0	-24	t ₋₁₂	b ₋₁₂	-8	t ₋₄	b ₋₄	8	t ₊₄	b ₊₄	24	t ₊₁₂	b ₊₁₂	24	t ₊₁₂	b ₊₁₂	
1	-23	b ₋₁₂	t ₋₁₁	-7	b ₋₄	t ₋₃	9	b ₊₄	t ₊₅	25	b ₊₁₂	t ₊₁₃	25	b ₊₁₂	t ₊₁₃	
2	-22	t ₋₁₁	b ₋₁₁	-6	t ₋₃	b ₋₃	10	t ₊₅	b ₊₅	26	t ₊₁₃	b ₊₁₃	26	t ₊₁₃	b ₊₁₃	
3	-21	b ₋₁₁	t ₋₁₀	-5	b ₋₃	t ₋₂	11	b ₊₅	t ₊₆	27	b ₊₁₃	t ₊₁₄	27	b ₊₁₃	t ₊₁₄	
4	-20	t ₋₁₀	b ₋₁₀	-4	t ₋₂	b ₋₂	12	t ₊₆	b ₊₆	28	t ₊₁₄	b ₊₁₄	28	t ₊₁₄	b ₊₁₄	
5	-19	b ₋₁₀	t ₋₉	-3	b ₋₂	t ₋₁	13	b ₊₆	t ₊₇	29	b ₊₁₄	t ₊₁₅	29	b ₊₁₄	t ₊₁₅	
6	-18	t ₋₉	b ₋₉	-2	t ₋₁	b ₋₁	14	t ₊₇	b ₊₇	30	t ₊₁₅	b ₊₁₅	30	t ₊₁₅	b ₊₁₅	
7	-17	b ₋₉	t ₋₈	-1	b ₋₁	t ₀	15	b ₊₇	t ₊₈	31	b ₊₁₅	t ₊₁₆	31	b ₊₁₅	t ₊₁₆	
8	-16	t ₋₈	b ₋₈	0	t ₀	b ₀	16	t ₊₈	b ₊₈	32	t ₊₁₆	b ₊₁₆	32	t ₊₁₆	b ₊₁₆	

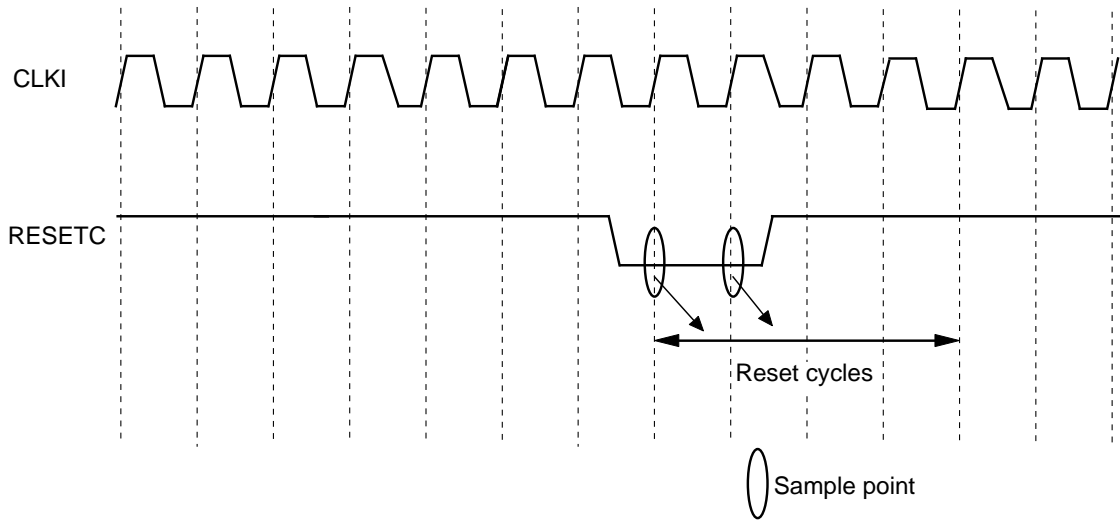

Fig. 4.1-1 Reset operation

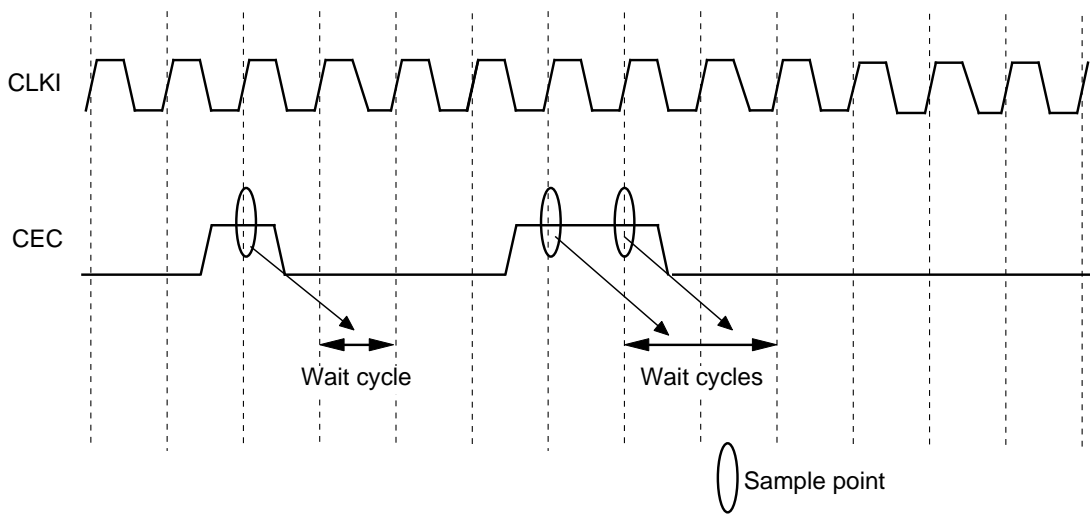

Fig. 4.2-1 Wait operation

Fig. 5.2-1a The order of priority for distortion equivalent vector in non-expansion mode

	-16	-15	-14	-13	-12	-11	-10	-9	-8	-7	-6	-5	-4	-3	-2	-1	0	1	2	3	4	5	6	7	8	9	10	11	12	13	14	15							
-16		32	31	30	29	28	27	26	25	24	23	22	21	20	19	18	17	16	17	18	19	20	21	22	23	24	25	26	27	28	29	30	32						
-15				31	30	29	28	27	26	25	24	23	22	21	20	19	18	17	16	15	16	17	18	19	20	21	22	23	24	25	26	27	28	29	31				
-14						30	29	28	27	26	25	24	23	22	21	20	19	18	17	16	15	14	15	16	17	18	19	20	21	22	23	24	25	26	27	28	30		
-13								29	28	27	26	25	24	23	22	21	20	19	18	17	16	15	14	13	14	15	16	17	18	19	20	21	22	23	24	25	26	27	29
-12										28	27	26	25	24	23	22	21	20	19	18	17	16	15	14	13	14	15	16	17	18	19	20	21	22	23	24	25	26	28
-11															27	26	25	24	23	22	21	20	19	18	17	16	15	16	17	18	19	20	21	22	23	24	25	27	
-10																					26	25	24	23	22	21	20	19	18	17	18	19	20	21	22	23	24	26	
-9																																						25	
-8																																						24	
-7																																						24	
-6																																						23	
-5																																						22	
-4																																						22	
-3																																						20	
-2																																						19	
-1																																						18	
0																																						17	
1																																						16	
2																																						17	
3																																						18	
4																																						19	
5																																						20	
6																																						21	
7																																						22	
8																																						23	
9																																						24	
10																																						25	
11																																						26	
12																																						27	
13																																						28	
14																																						29	
15																																						30	
16																																						31	
																																						32	

The smaller the value, the higher the priority.

$$P(X,Y) = |X| + |Y|$$

Fig. 5.2-1c The order of priority for distortion equivalent vector in lower-range of expansion mode

	-16	-15	-14	-13	-12	-11	-10	-9	-8	-7	-6	-5	-4	-3	-2	-1	0	1	2	3	4	5	6	7	8	9	10	11	12	13	14	15																																	
-16		16	15	14	13	12	11	10	9	8	7	6	5	4	3	2	1	0	1	2	3	4	5	6	7	8	9	10	11	12	13	14	15																																
-15			17	16	15	14	13	12	11	10	9	8	7	6	5	4	3	2	1	2	3	4	5	6	7	8	9	10	11	12	13	14	15	16																															
-14				18	17	16	15	14	13	12	11	10	9	8	7	6	5	4	3	2	3	4	5	6	7	8	9	10	11	12	13	14	15	16	17																														
-13					19	18	17	16	15	14	13	12	11	10	9	8	7	6	5	4	3	4	5	6	7	8	9	10	11	12	13	14	15	16	17	18																													
-12						20	19	18	17	16	15	14	13	12	11	10	9	8	7	6	5	6	7	8	9	10	11	12	13	14	15	16	17	18	19	20																													
-11							21	20	19	18	17	16	15	14	13	12	11	10	9	8	7	8	9	10	11	12	13	14	15	16	17	18	19	20	21	22																													
-10								22	21	20	19	18	17	16	15	14	13	12	11	10	9	10	11	12	13	14	15	16	17	18	19	20	21	22	23	24																													
-9									23	22	21	20	19	18	17	16	15	14	13	12	11	10	11	12	13	14	15	16	17	18	19	20	21	22	23	24	25																												
-8										24	23	22	21	20	19	18	17	16	15	14	13	12	13	14	15	16	17	18	19	20	21	22	23	24	25	26	27																												
-7											25	24	23	22	21	20	19	18	17	16	15	14	15	16	17	18	19	20	21	22	23	24	25	26	27	28	29																												
-6												26	25	24	23	22	21	20	19	18	17	16	17	18	19	20	21	22	23	24	25	26	27	28	29	30	31																												
-5													27	26	25	24	23	22	21	20	19	18	17	18	19	20	21	22	23	24	25	26	27	28	29	30	31	32																											
-4														28	27	26	25	24	23	22	21	20	19	18	19	20	21	22	23	24	25	26	27	28	29	30	31	32	33																										
-3															29	28	27	26	25	24	23	22	21	20	19	20	21	22	23	24	25	26	27	28	29	30	31	32	33	34																									
-2																30	29	28	27	26	25	24	23	22	21	20	21	22	23	24	25	26	27	28	29	30	31	32	33	34	35																								
-1																	31	30	29	28	27	26	25	24	23	22	21	22	23	24	25	26	27	28	29	30	31	32	33	34	35	36																							
0																		32	31	30	29	28	27	26	25	24	23	22	23	24	25	26	27	28	29	30	31	32	33	34	35	36																							
1																			33	32	31	30	29	28	27	26	25	24	23	24	25	26	27	28	29	30	31	32	33	34	35	36																							
2																				34	33	32	31	30	29	28	27	26	25	24	25	26	27	28	29	30	31	32	33	34	35	36																							
3																					35	34	33	32	31	30	29	28	27	26	25	24	25	26	27	28	29	30	31	32	33	34	35	36																					
4																						36	35	34	33	32	31	30	29	28	27	26	25	24	25	26	27	28	29	30	31	32	33	34	35	36																			
5																							37	36	35	34	33	32	31	30	29	28	27	26	25	24	25	26	27	28	29	30	31	32	33	34	35	36																	
6																								38	37	36	35	34	33	32	31	30	29	28	27	26	25	24	25	26	27	28	29	30	31	32	33	34	35	36															
7																									39	38	37	36	35	34	33	32	31	30	29	28	27	26	25	24	25	26	27	28	29	30	31	32	33	34	35	36													
8																										40	39	38	37	36	35	34	33	32	31	30	29	28	27	26	25	24	25	26	27	28	29	30	31	32	33	34	35	36											
9																											41	40	39	38	37	36	35	34	33	32	31	30	29	28	27	26	25	24	25	26	27	28	29	30	31	32	33	34	35	36									
10																												42	41	40	39	38	37	36	35	34	33	32	31	30	29	28	27	26	25	24	25	26	27	28	29	30	31	32	33	34	35	36							
11																												43	42	41	40	39	38	37	36	35	34	33	32	31	30	29	28	27	26	25	24	25	26	27	28	29	30	31	32	33	34	35	36						
12																												44	43	42	41	40	39	38	37	36	35	34	33	32	31	30	29	28	27	26	25	24	25	26	27	28	29	30	31	32	33	34	35	36					
13																												45	44	43	42	41	40	39	38	37	36	35	34	33	32	31	30	29	28	27	26	25	24	25	26	27	28	29	30	31	32	33	34	35	36				
14																												46	45	44	43	42	41	40	39	38	37	36	35	34	33	32	31	30	29	28	27	26	25	24	25	26	27	28	29	30	31	32	33	34	35	36			
15																												47	46	45	44	43	42	41	40	39	38	37	36	35	34	33	32	31	30	29	28	27	26	25	24	25	26	27	28	29	30	31	32	33	34	35	36		
16																													48	47	46	45	44	43	42	41	40	39	38	37	36	35	34	33	32	31	30	29	28	27	26	25	24	25	26	27	28	29	30	31	32	33	34	35	36

The smaller the value, the higher the priority.

$$P(X,Y) = |X| + (Y + 16)$$

Fig. 5.2-1b The order of priority for distortion equivalent vector in upper-range of expansion mode

	-16	-15	-14	-13	-12	-11	-10	-9	-8	-7	-6	-5	-4	-3	-2	-1	0	1	2	3	4	5	6	7	8	9	10	11	12	13	14	15
-16	48	47	46	45	44	43	42	41	40	39	38	37	36	35	34	33	32	33	34	35	36	37	38	39	40	41	42	43	44	45	46	47
-15	47	46	45	44	43	42	41	40	39	38	37	36	35	34	33	32	31	32	33	34	35	36	37	38	39	40	41	42	43	44	45	46
-14	46	45	44	43	42	41	40	39	38	37	36	35	34	33	32	31	30	31	32	33	34	35	36	37	38	39	40	41	42	43	44	45
-13	45	44	43	42	41	40	39	38	37	36	35	34	33	32	31	30	29	30	31	32	33	34	35	36	37	38	39	40	41	42	43	44
-12	44	43	42	41	40	39	38	37	36	35	34	33	32	31	30	29	28	29	30	31	32	33	34	35	36	37	38	39	40	41	42	43
-11	43	42	41	40	39	38	37	36	35	34	33	32	31	30	29	28	27	28	29	30	31	32	33	34	35	36	37	38	39	40	41	42
-10	42	41	40	39	38	37	36	35	34	33	32	31	30	29	28	27	26	27	28	29	30	31	32	33	34	35	36	37	38	39	40	41
-9	41	40	39	38	37	36	35	34	33	32	31	30	29	28	27	26	25	26	27	28	29	30	31	32	33	34	35	36	37	38	39	40
-8	40	39	38	37	36	35	34	33	32	31	30	29	28	27	26	25	24	25	26	27	28	29	30	31	32	33	34	35	36	37	38	39
-7	39	38	37	36	35	34	33	32	31	30	29	28	27	26	25	24	26	24	25	26	27	28	29	30	31	32	33	34	35	36	37	38
-6	38	37	36	35	34	33	32	31	30	29	28	27	26	25	24	26	22	26	24	25	26	27	28	29	30	31	32	33	34	35	36	37
-5	37	36	35	34	33	32	31	30	29	28	27	26	25	24	26	22	21	22	26	24	25	26	27	28	29	30	31	32	33	34	35	36
-4	36	35	34	33	32	31	30	29	28	27	26	25	24	26	22	21	20	21	22	26	24	25	26	27	28	29	30	31	32	33	34	35
-3	35	34	33	32	31	30	29	28	27	26	25	24	26	22	21	20	19	20	21	22	26	24	25	26	27	28	29	30	31	32	33	34
-2	34	33	32	31	30	29	28	27	26	25	24	26	22	21	20	19	18	19	20	21	22	26	24	25	26	27	28	29	30	31	32	33
-1	33	32	31	30	29	28	27	26	25	24	26	22	21	20	19	18	17	18	19	20	21	22	26	24	25	26	27	28	29	30	31	32
0	32	31	30	29	28	27	26	25	24	26	22	21	20	19	18	17	16	17	18	19	20	21	22	26	24	25	26	27	28	29	30	31
1	31	30	29	28	27	26	25	24	26	22	21	20	19	18	17	16	15	16	17	18	19	20	21	22	26	24	25	26	27	28	29	30
2	30	29	28	27	26	25	24	26	22	21	20	19	18	17	16	15	14	15	16	17	18	19	20	21	22	26	24	25	26	27	28	29
3	29	28	27	26	25	24	26	22	21	20	19	18	17	16	15	14	13	14	15	16	17	18	19	20	21	22	26	24	25	26	27	28
4	28	27	26	25	24	26	22	21	20	19	18	17	16	15	14	13	12	13	14	15	16	17	18	19	20	21	22	26	24	25	26	27
5	27	26	25	24	26	22	21	20	19	18	17	16	15	14	13	12	11	12	13	14	15	16	17	18	19	20	21	22	26	24	25	26
6	26	25	24	26	22	21	20	19	18	17	16	15	14	13	12	11	10	11	12	13	14	15	16	17	18	19	20	21	22	26	24	25
7	25	24	26	22	21	20	19	18	17	16	15	14	13	12	11	10	9	10	11	12	13	14	15	16	17	18	19	20	21	22	26	24
8	24	26	22	21	20	19	18	17	16	15	14	13	12	11	10	9	8	9	10	11	12	13	14	15	16	17	18	19	20	21	22	26
9	26	22	21	20	19	18	17	16	15	14	13	12	11	10	9	8	7	8	9	10	11	12	13	14	15	16	17	18	19	20	21	22
10	22	21	20	19	18	17	16	15	14	13	12	11	10	9	8	7	6	7	8	9	10	11	12	13	14	15	16	17	18	19	20	21
11	21	20	19	18	17	16	15	14	13	12	11	10	9	8	7	6	5	6	7	8	9	10	11	12	13	14	15	16	17	18	19	20
12	20	19	18	17	16	15	14	13	12	11	10	9	8	7	6	5	4	5	6	7	8	9	10	11	12	13	14	15	16	17	18	19
13	19	18	17	16	15	14	13	12	11	10	9	8	7	6	5	4	3	4	5	6	7	8	9	10	11	12	13	14	15	16	17	18
14	18	17	16	15	14	13	12	11	10	9	8	7	6	5	4	3	2	3	4	5	6	7	8	9	10	11	12	13	14	15	16	17
15	17	16	15	14	13	12	11	10	9	8	7	6	5	4	3	2	1	2	3	4	5	6	7	8	9	10	11	12	13	14	15	16
16	16	15	14	13	12	11	10	9	8	7	6	5	4	3	2	1	0	1	2	3	4	5	6	7	8	9	10	11	12	13	14	15

The smaller the value, the higher the priority.

$$P(X,Y) = |X| + (-Y + 16)$$

Fig. 5.5-2a Horizontal search range control for 2-chips

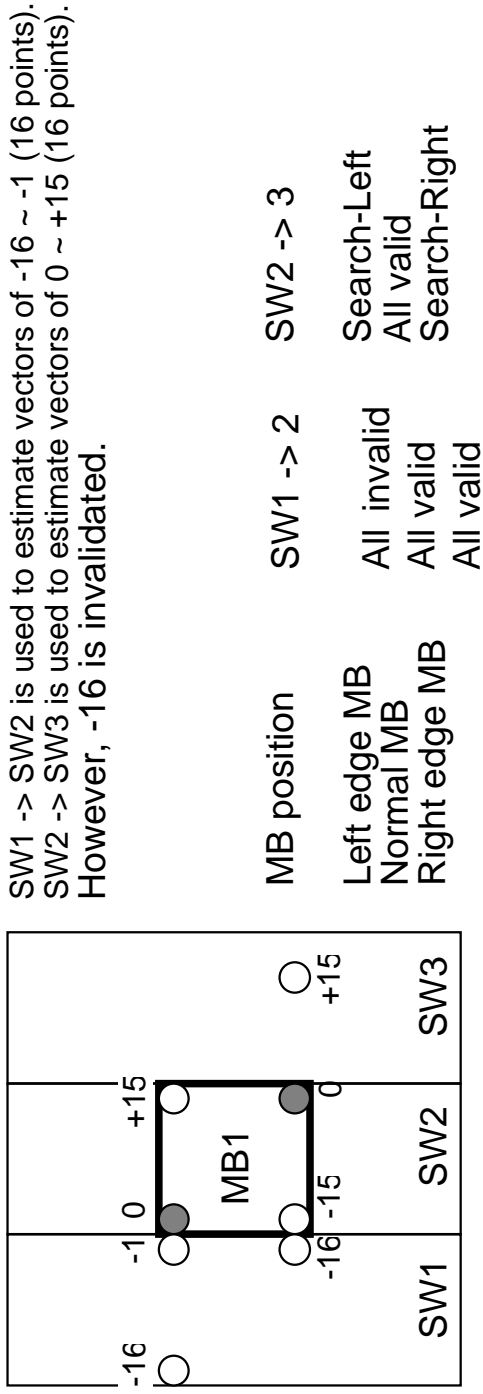

Fig. 5.5-2b Horizontal search range control for 4-chips

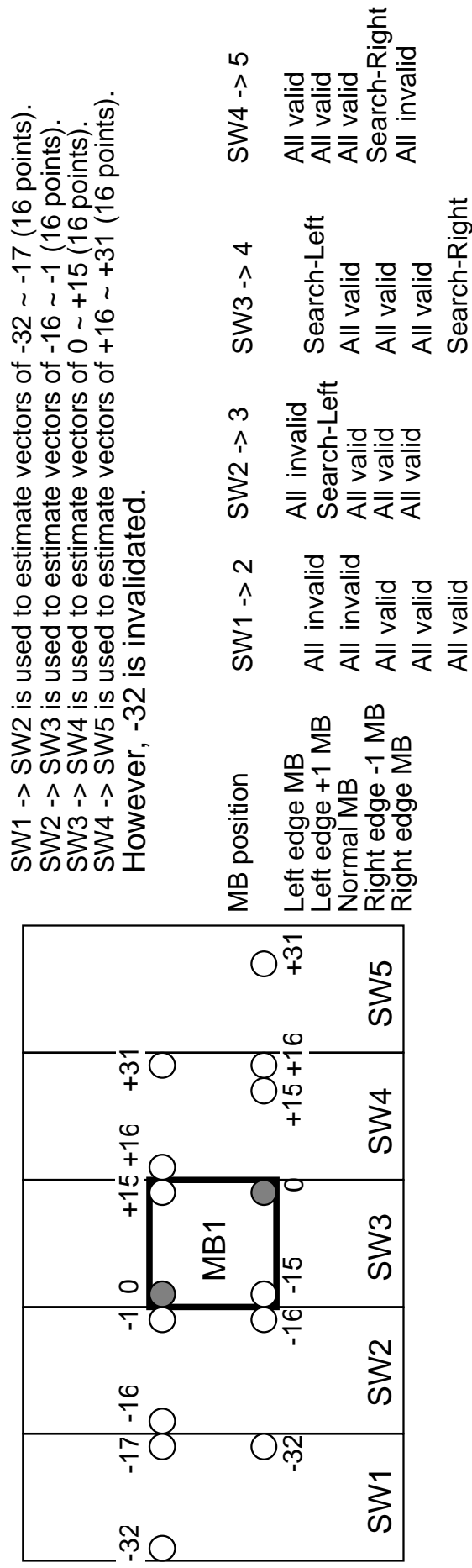
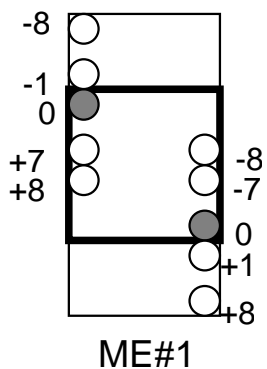
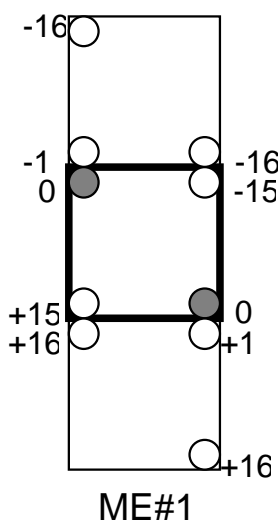

Fig. 5.5-1b Vertical search range control for 1-chip



One chip estimates vectors of $-7.5 \sim +7.5$ in non-expansion mode.

One chip estimates vectors of $-8.0 \sim +8.0$ in vertical expansion mode.



One chip estimates vectors of $-15.5 \sim +15.5$ in non-expansion mode.

One chip estimates vectors of $-16.0 \sim +16.0$ in vertical expansion mode.

MB position	ME#1
Top edge MB	Search-Top
Normal MB	All valid
Bottom edge MB	Search-Bottom

Fig. 5.5-1c Vertical search range control for 1-chip

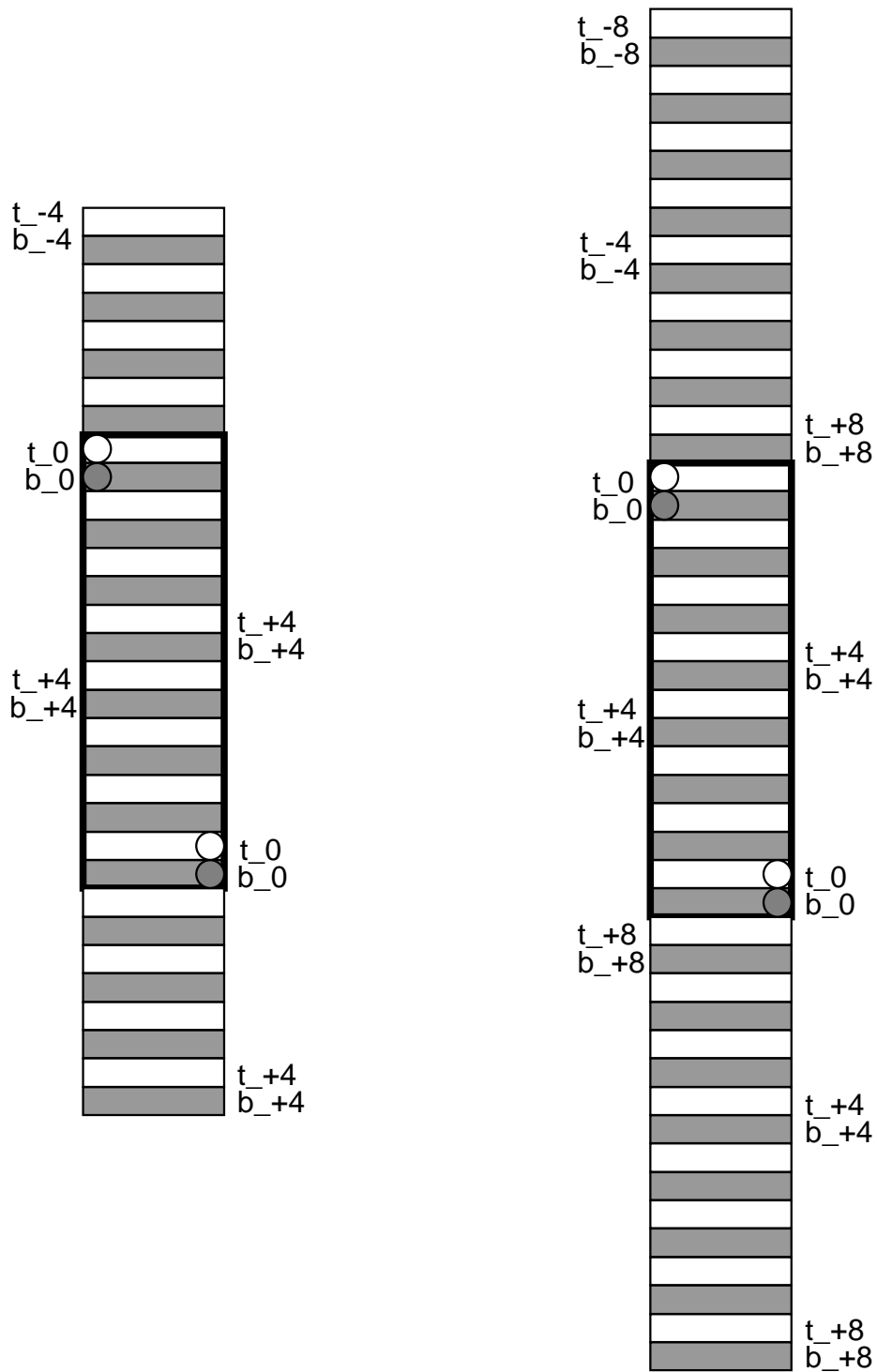

Fig. 5.5-3c Vertical search range control for 2-chips

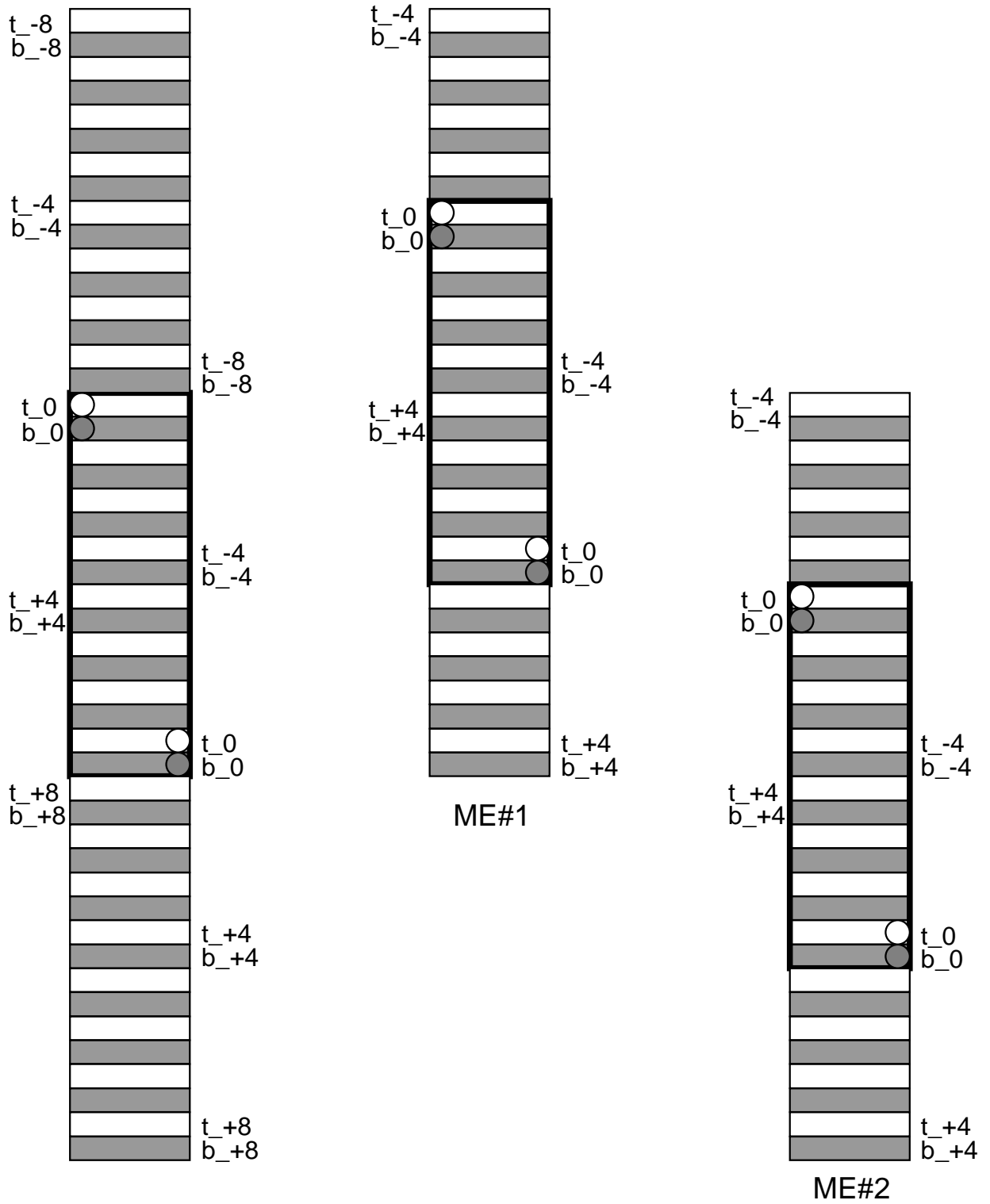

Fig. 5.5-3d Vertical search range control for 2-chips

All chips are operated in expansion mode.

ME#1 estimates vectors of $-32.0 \sim 0.0$.

ME#2 estimates vectors of $0.0 \sim +32.0$.

So, the total search range is $-32.0 \sim +32.0$

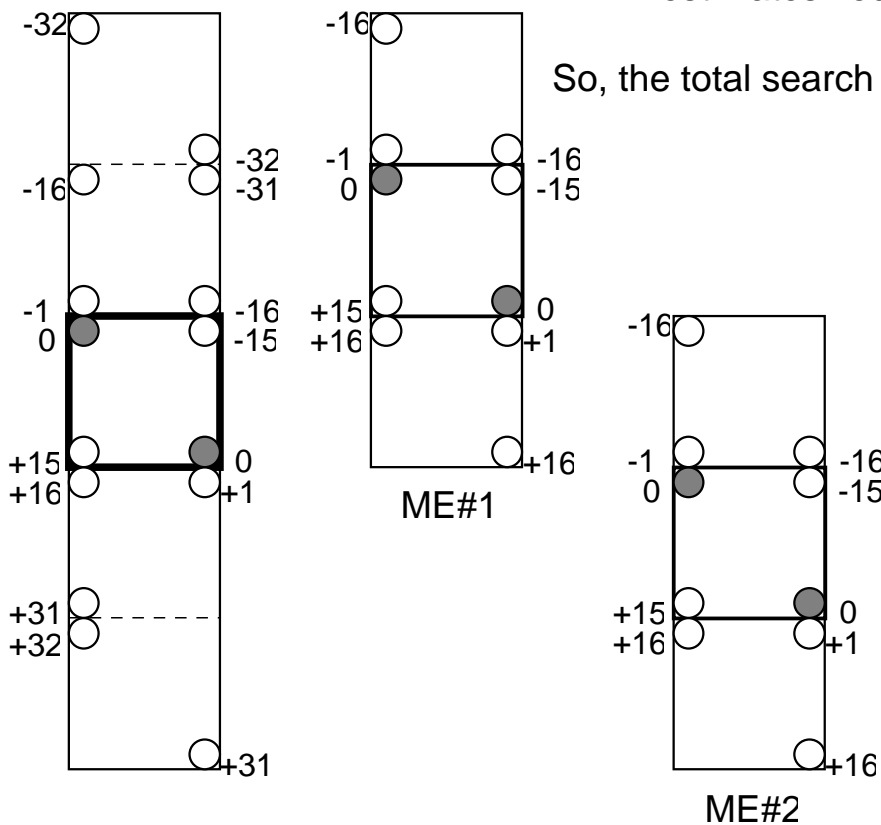

MB position	ME#1	ME#2
Top edge MB	All invalid	All valid
Top edge +1 MB	Search-Top	All valid
Normal MB	All valid	All valid
Bottom edge -1 MB	All valid	Search-Bottom
Bottom edge MB	All valid	All invalid

Fig. 5.5-3f Vertical search range control for 2-chips

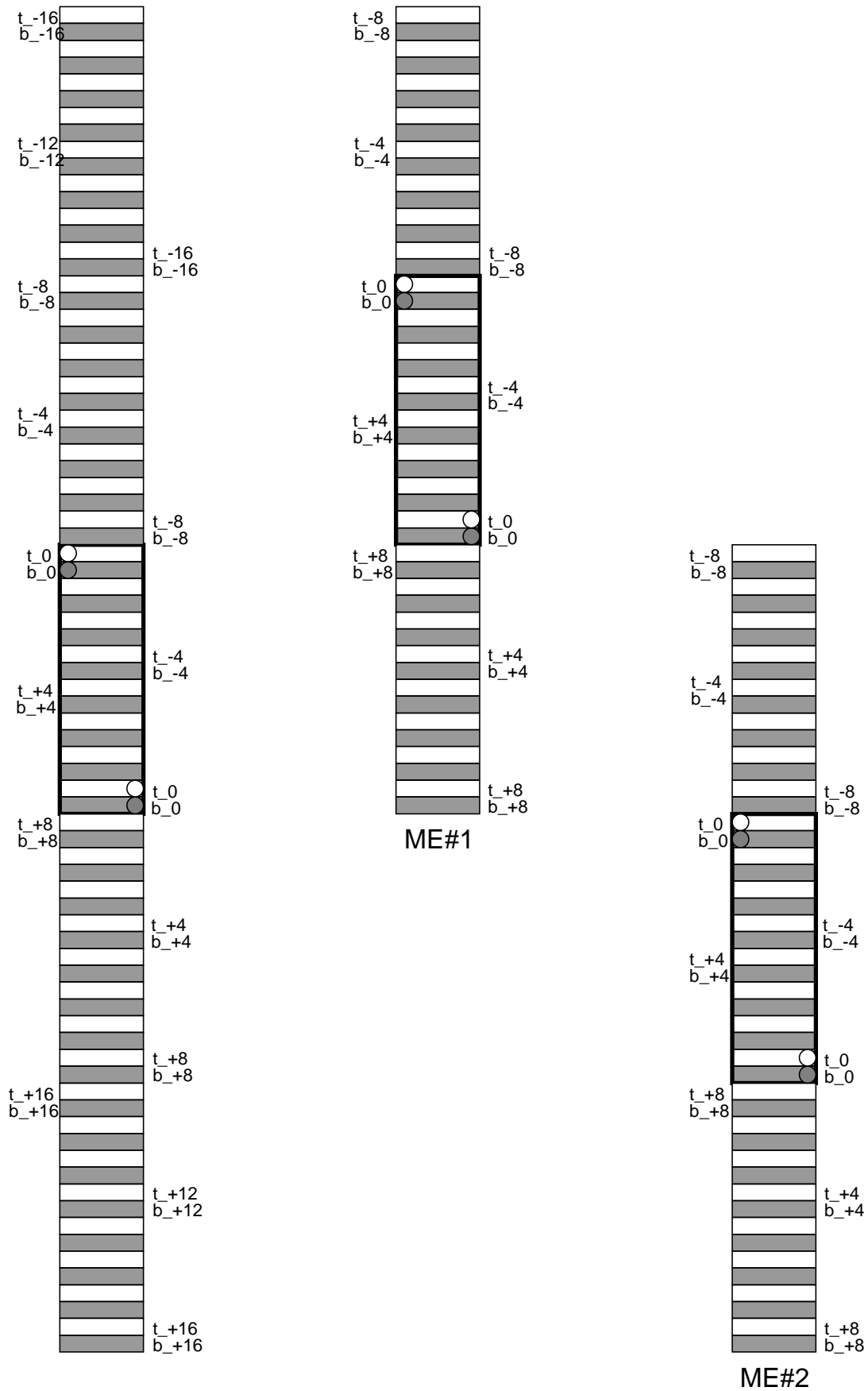

Fig. 5.6-1a Operation timing for 1-chip (vertical search range = ± 7.5)

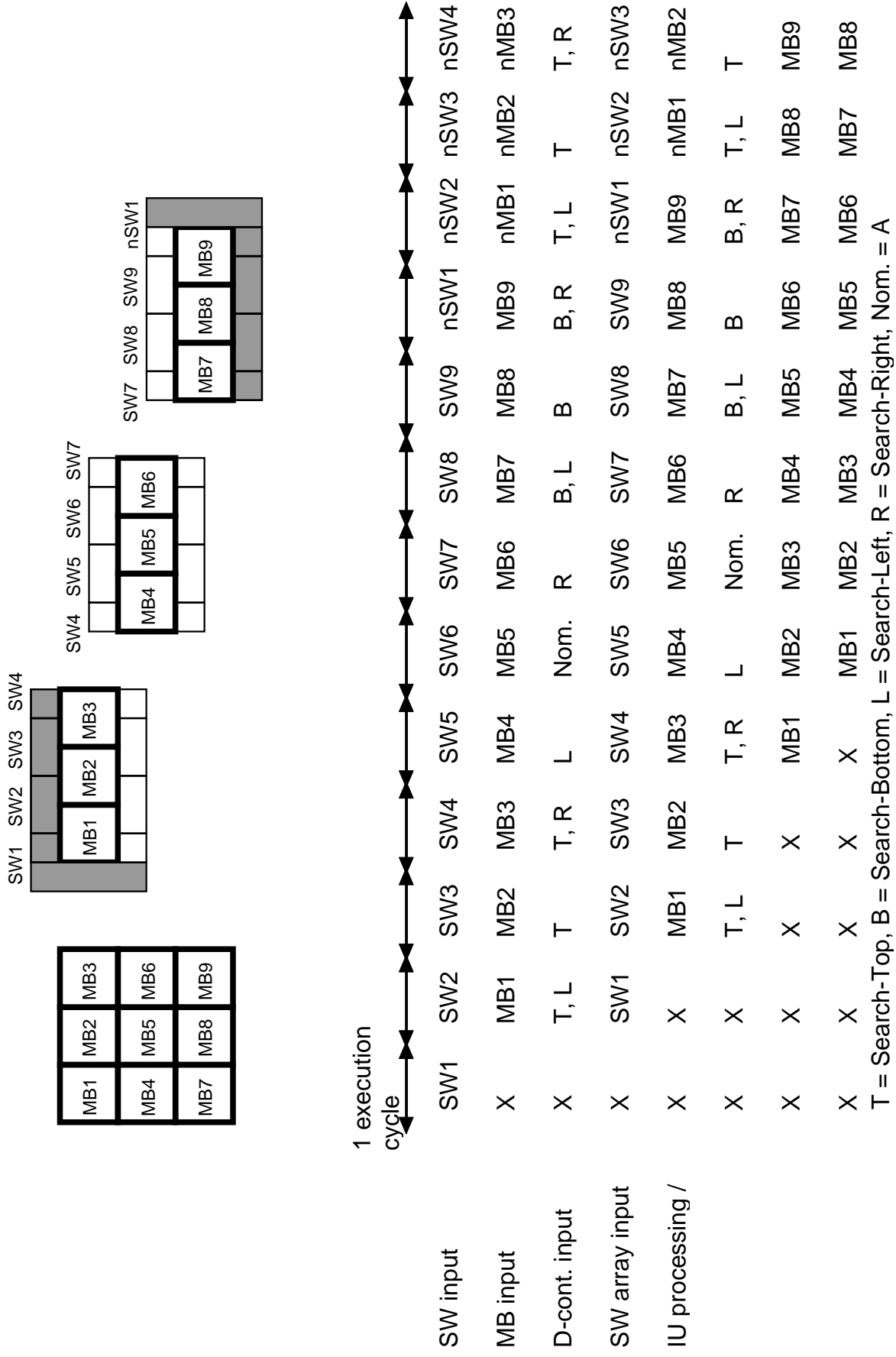
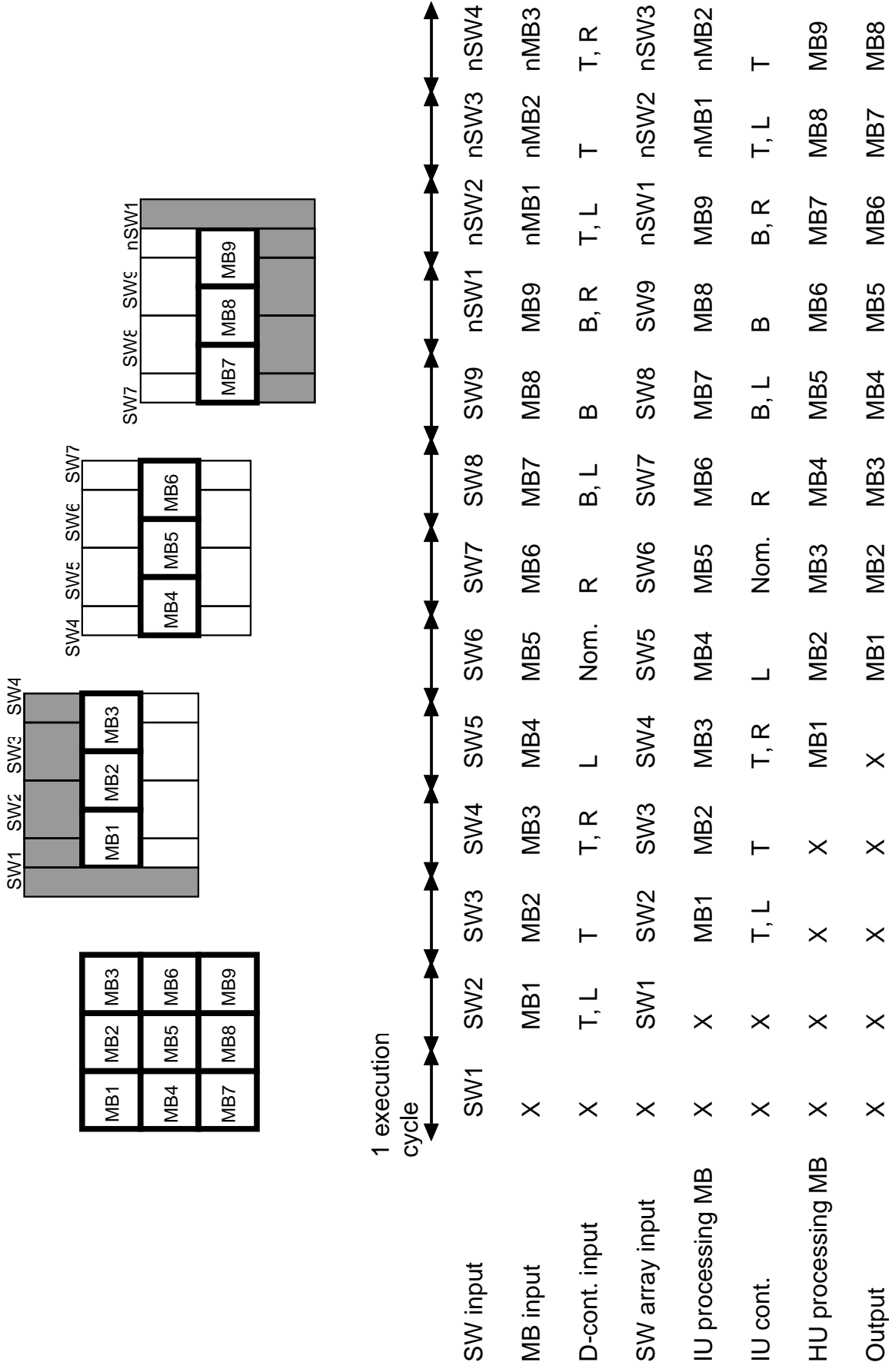

Fig. 5.6-1b Operation timing for 1-chip (vertical search range = ±15.5)



1 execution cycle

SW input	SW1	SW2	SW3	SW4	SW5	SW6	SW7	SW8	SW9	nSW1	nSW2	nSW3	nSW4
MB input	X	MB1	MB2	MB3	MB4	MB5	MB6	MB7	MB8	MB9	nMB1	nMB2	nMB3
D-cont. input	X	T, L	T	T, R	L	Nom.	R	B, L	B	B, R	T, L	T	T, R
SW array input	X	SW1	SW2	SW3	SW4	SW5	SW6	SW7	SW8	SW9	nSW1	nSW2	nSW3
IU processing MB	X	X	MB1	MB2	MB3	MB4	MB5	MB6	MB7	MB8	MB9	nMB1	nMB2
IU cont.	X	X	T, L	T	T, R	L	Nom.	R	B, L	B	B, R	T, L	T
HU processing MB	X	X	X	X	MB1	MB2	MB3	MB4	MB5	MB6	MB7	MB8	MB9
Output	X	X	X	X	X	MB1	MB2	MB3	MB4	MB5	MB6	MB7	MB8

T = Search-Top, B = Search-Bottom, L = Search-Left, R = Search-Right, Nom. = A

Fig. 5.6-1c Operation timing for horizontal 2-chips expansion (vertical search range = ±15.5)

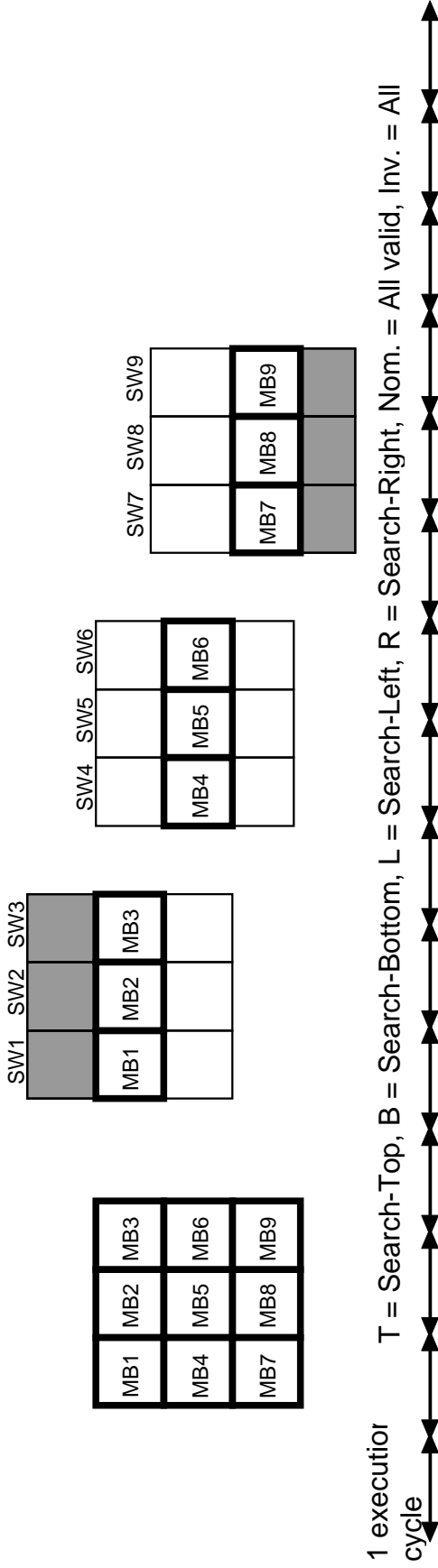

ME#1	SW1	SW2	SW3	SW4	SW5	SW6	SW7	SW8	SW9	nSW1	nSW2	nSW3	nSW4	nSW5	nSW6
SW input	SW1	SW2	SW3	SW4	SW5	SW6	SW7	SW8	SW9	nSW1	nSW2	nSW3	nSW4	nSW5	nSW6
MB input	MB1	MB2	MB3	MB4	MB5	MB6	MB7	MB8	MB9	-	nMB2	-	nMB4	-	nMB6
D-cont. input	Inv.	T, L	T	T, R	Nom.	Nom.	Inv.	B, L	B	B, R	T	Inv.	Inv.	L	Nom.
SW array input	X	SW1	SW2	SW3	SW4	SW5	SW6	SW7	SW8	SW9	nSW1	nSW2	nSW3	nSW4	nSW5
IU processing MB	X	MB1	MB2	MB3	MB4	MB5	MB6	MB7	MB8	MB9	MB9	nMB2	nMB2	nMB4	nMB4
IU cont.	X	Inv.	T, L	T	T, R	Nom.	Nom.	Inv.	B, L	B	B, R	T	T	Inv.	L
HU processing MB	X	X	X	X	MB1	-	MB3	-	MB5	-	MB7	-	MB9	-	nMB2
Output	X	X	X	X	X	MB1	-	MB3	-	MB5	-	MB7	-	MB9	-
ME#2	SW1	SW2	SW3	SW4	SW5	SW6	SW7	SW8	SW9	nSW1	nSW2	nSW3	nSW4	nSW5	nSW6
SW input	SW1	SW2	SW3	SW4	SW5	SW6	SW7	SW8	SW9	nSW1	nSW2	nSW3	nSW4	nSW5	nSW6
MB input	X	MB2	-	MB4	-	MB6	-	MB8	-	nMB1	-	nMB3	-	nMB5	-
D-cont. input	X	T	T	Inv.	L	Nom.	R	B	B	Inv.	T, L	T	T, R	Nom.	Nom.
SW array input	X	SW1	SW2	SW3	SW4	SW5	SW6	SW7	SW8	SW9	nSW1	nSW2	nSW3	nSW4	nSW5
IU processing MB	X	X	MB2	MB2	MB4	MB4	MB6	MB6	MB8	MB8	nMB1	nMB1	nMB3	nMB3	nMB3
IU cont.	X	X	T	T	Inv.	L	Nom.	R	B	Inv.	Inv.	T, L	T	T, R	Nom.
HU processing MB	X	X	X	X	X	MB2	-	MB4	-	MB6	-	MB8	-	nMB1	-
Output	X	X	X	X	X	X	MB2	-	MB4	-	MB6	-	MB8	-	nMB1

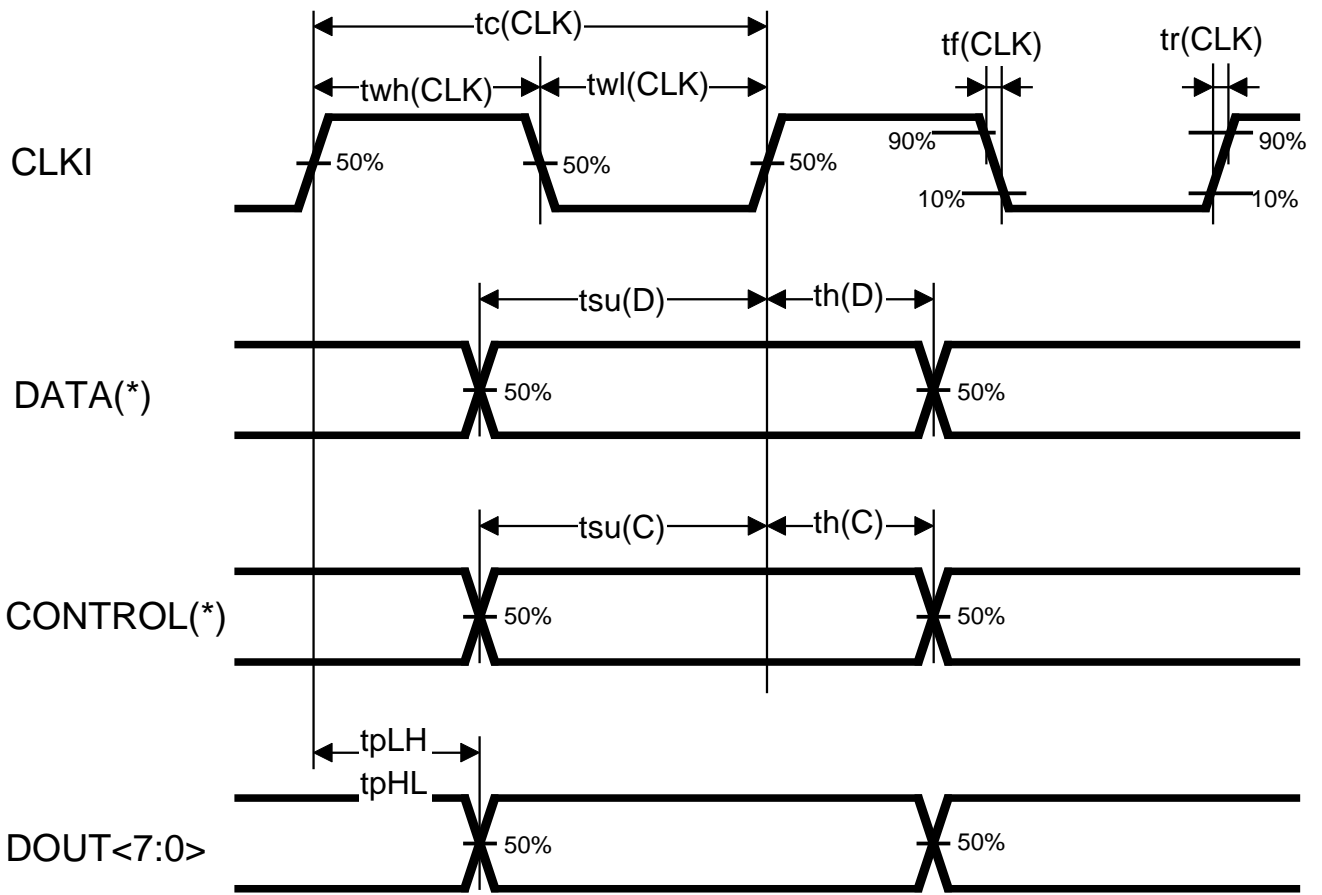

(*) DATA : DSWI<31:0>, DMBI<7:0>
 CONTROL : Input Pins without DSWI, DMBI, CLKI, OEC

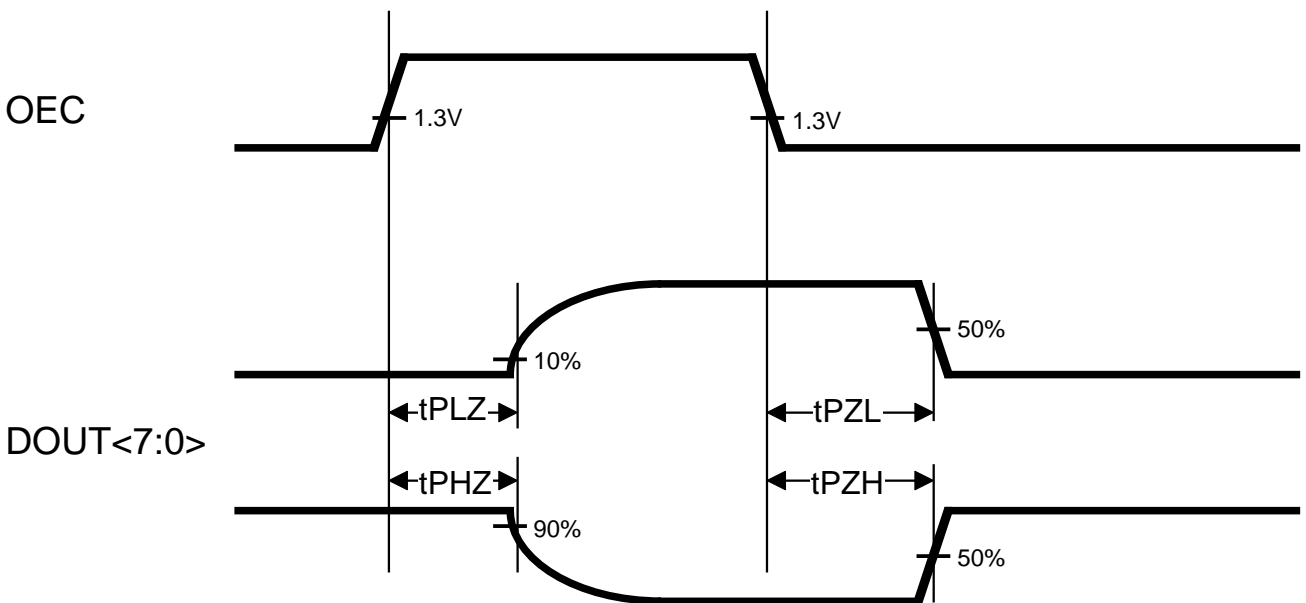

Fig. 6.1.5-1 Timing Diagram

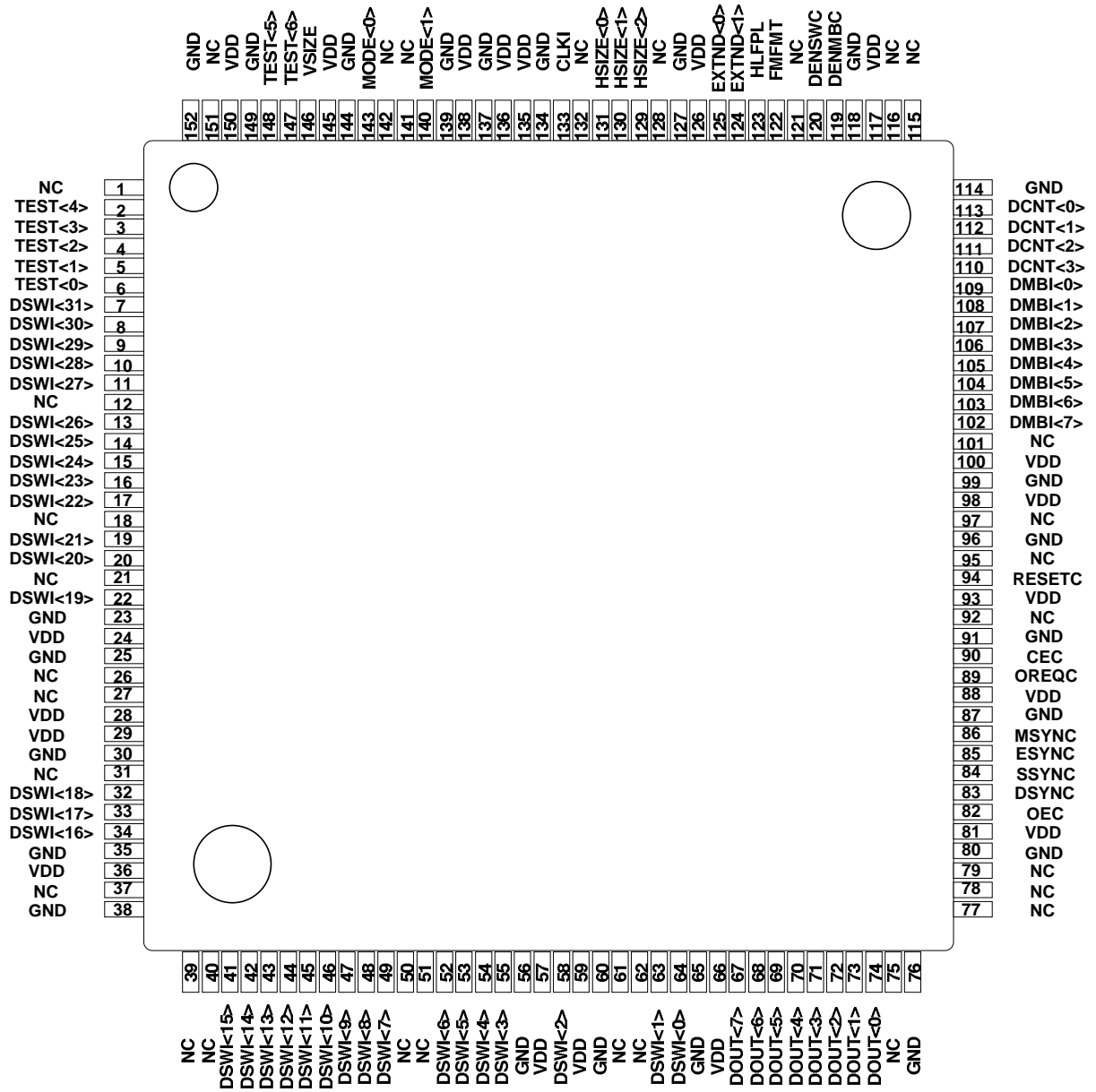

Fig. 6.2-2 Pin Configuration of M65727FP

Table 6.2-1 Pin Configuration of M65727FP

Pin number	Pin name	Pin number	Pin name	Pin number	Pin name	Pin number	Pin name
1	NC	39	NC	77	NC	115	NC
2	TEST<4>	40	NC	78	NC	116	NC
3	TEST<3>	41	DSWI<15>	79	NC	117	VDD
4	TEST<2>	42	DSWI<14>	80	GND	118	GND
5	TEST<1>	43	DSWI<13>	81	VDD	119	DENMBC
6	TEST<0>	44	DSWI<12>	82	OEC	120	DENSWC
7	DSWI<31>	45	DSWI<11>	83	DSYNC	121	NC
8	DSWI<30>	46	DSWI<10>	84	SSYNC	122	FMFMT
9	DSWI<29>	47	DSWI<9>	85	ESYNC	123	HLFPL
10	DSWI<28>	48	DSWI<8>	86	MSYNC	124	EXTND<1>
11	DSWI<27>	49	DSWI<7>	87	GND	125	EXTND<0>
12	NC	50	NC	88	VDD	126	VDD
13	DSWI<26>	51	NC	89	OREQC	127	GND
14	DSWI<25>	52	DSWI<6>	90	CEC	128	NC
15	DSWI<24>	53	DSWI<5>	91	GND	129	HSIZE<2>
16	DSWI<23>	54	DSWI<4>	92	NC	130	HSIZE<1>
17	DSWI<22>	55	DSWI<3>	93	VDD	131	HSIZE<0>
18	NC	56	GND	94	RESETC	132	NC
19	DSWI<21>	57	VDD	95	NC	133	CLKI
20	DSWI<20>	58	DSWI<2>	96	GND	134	GND
21	NC	59	VDD	97	NC	135	VDD
22	DSWI<19>	60	GND	98	VDD	136	VDD
23	GND	61	NC	99	GND	137	GND
24	VDD	62	NC	100	VDD	138	VDD
25	GND	63	DSWI<1>	101	NC	139	GND
26	NC	64	DSWI<0>	102	DMBI<7>	140	MODE<1>
27	NC	65	GND	103	DMBI<6>	141	NC
28	VDD	66	VDD	104	DMBI<5>	142	NC
29	VDD	67	DOUT<7>	105	DMBI<4>	143	MODE<0>
30	GND	68	DOUT<6>	106	DMBI<3>	144	GND
31	NC	69	DOUT<5>	107	DMBI<2>	145	VDD
32	DSWI<18>	70	DOUT<4>	108	DMBI<1>	146	VSIZE
33	DSWI<17>	71	DOUT<3>	109	DMBI<0>	147	TEST<6>
34	DSWI<16>	72	DOUT<2>	110	DCNT<3>	148	TEST<5>
35	GND	73	DOUT<1>	111	DCNT<2>	149	GND
36	VDD	74	DOUT<0>	112	DCNT<1>	150	VDD
37	NC	75	NC	113	DCNT<0>	151	NC
38	GND	76	GND	114	GND	152	GND