

BATTERY CHARGE I.C.

- DEDICATED I.C. FOR 1 LI-ION CELL OR 3 NI-MH CELLS
- 5 DIFFERENT OPERATING MODES
- 150 mA PRECHARGE CURRENT
- VERY LOW DROP CHARGE SWITCH (130mV @ 800mA)
- VERY LOW DROP REVERSE SWITCH (130mV @ 800mA)
- 5.7V OVER BATTERY OVER VOLTAGE PROTECTION
- CHARGER DETECTION MODE
- ($V_{CHARGE} - V_{BATT}$) DETECTION MODE

DESCRIPTION

This specification describes a dedicated I.C. which allows to charge 1 Lilon cell or 3 Nimh cells. The principle used to charge the batteries is the pulsed current, the monitoring is operated by the micro-controller of the application. This IC integrates one Power Switch and achieves the

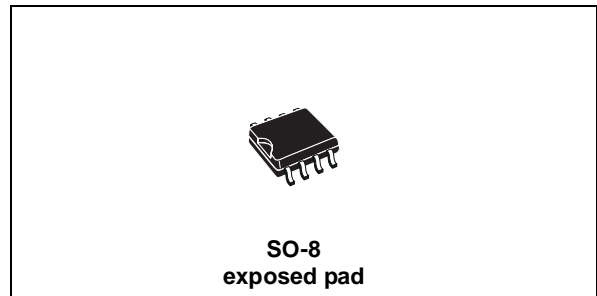

charge batteries in two different modes charge or precharge.

One of this operating mode (charge or precharge) can be selected in a static or pulsed way by one I/O from a micro-controller. The IC can supply power to accessories controlled by this I.C. in Reverse mode. The I.C. is available in the smaller and surface mounted SO-8 (exposed pad version) package.

SCHEMATIC DIAGRAM

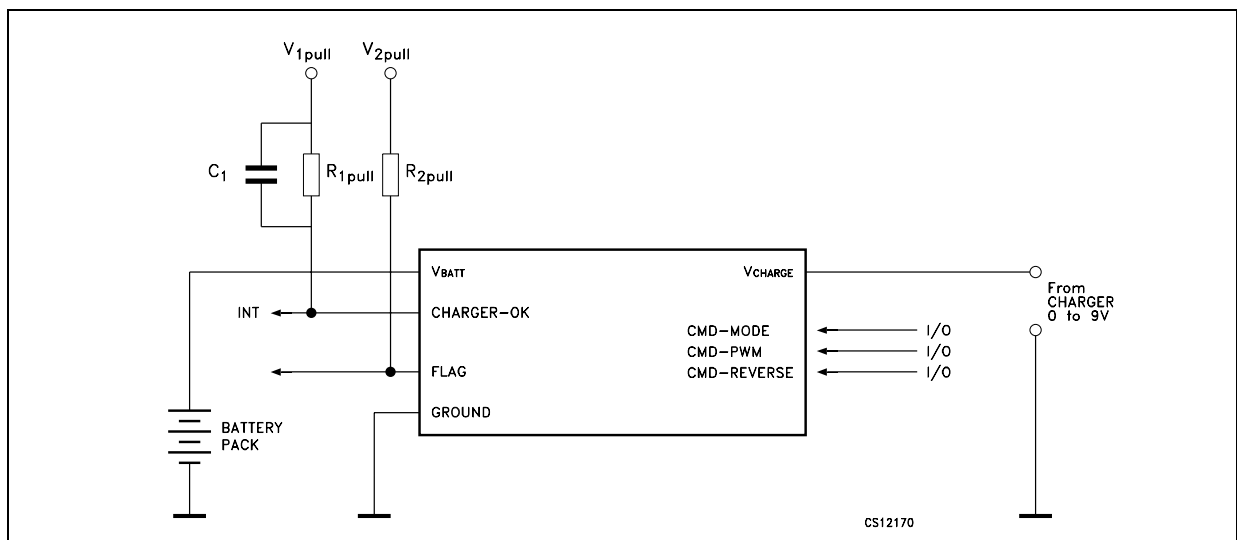

ABSOLUTE MAXIMUM RATINGS

Symbol	Parameter	Value	Unit	
V _{BATT}	Battery Voltage	-0.3 to 6	V	
V _{CHARGE}	Charge Voltage (*)	-12 to 16	V	
V _{FLAG}	(V _{CHARGE} - V _{BATT}) Flag Control Voltage	-0.3 to 12	V	
V _{CHARGER-OK}	Charger Flag Control Voltage	-0.3 to 12	V	
V _{CMD-PWM}	PWM Command Voltage	-0.3 to 5	V	
V _{CMD-MODE}	CMD Command Voltage	-0.3 to 5	V	
V _{CMD-REVERSE}	Reverse Command Voltage	-0.3 to 5	V	
I _{SWITCH}	Internal Switch Continuous Max Current	T _{AMB} = 85°C, R _{thj-amb} = 40°C/W	2	A
		T _{AMB} = 30°C, R _{thj-amb} = 40°C/W	3	A
	Internal Switch Peak Current	T < 1ms Duty Cycle < 1% R _{thj-amb} = 40°C/W	8	A
T _{stg}	Storage Temperature Range	-55 to +125	°C	
T _J	Operating Junction Temperature Range	-40 to +125	°C	
T _{AMB}	Operating Ambient Temperature Range (if an adequate heatsink is provided)	-40 to +85	°C	

Absolute Maximum Ratings are those values beyond which damage to the device may occur. Functional operation under these condition is not implied.

(*) The I.C. is automatically turned OFF when V_{CHARGE} reaches typically 14V (V_{CHARGE} rising edge); typical hysteresis is 700mV (V_{CHARGE} falling edge)

THERMAL DATA

Symbol	Parameter	SO-8	Unit
R _{thj-case}	Thermal Resistance Junction-case	10	°C/W

ORDERING CODES

TYPE	SO-8 exposed pad	SO-8 exposed pad (T&R)
ST3S01LED	ST3S01LED	ST3S01LED-TR

CONNECTION DIAGRAM (top view)

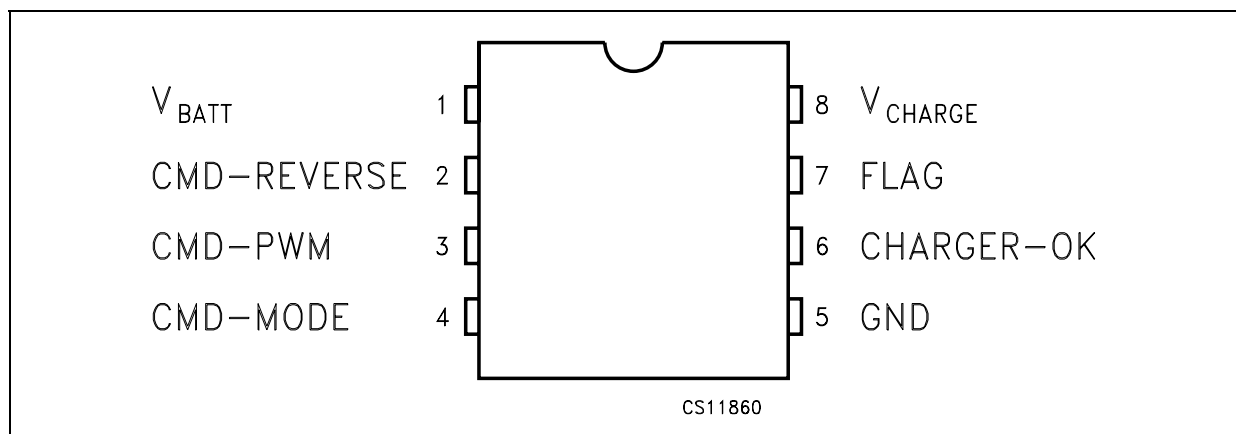

PIN DESCRIPTION

Pin N°	Symbol	Name and Function
1	V_{BATT}	BATTERY pin: input pin when reverse mode is selected; output pin when in charge or precharge mode
2	CMD-REVERSE	Reverse Command pin: Enables the reverse mode when connected to a positive voltage higher than 1.2V. Logic pin internally pulled down.
3	CMD-PWM	PWM Command pin: allows to control the precharge or charge switch in PWM mode (refer to the Table 1 for the different operating modes). Logic pin internally pulled down.
4	CMD-MODE	Mode Command pin: allows to switch between precharge and charge mode (refer to OPERATING MODES Table). Logic pin internally pulled down.
5	GND	GND Pin
6	CHARGER-OK	CHARGER-OK output pin; open drain N-channel MOSFET that is in high impedance when the V_{CHARGE} voltage drops below 2.5V and CMD-REVERSE is low. When the reverse function is activated, this open drain have the same information of the ($V_{CHARGE} - V_{BATT}$) FLAG.
7	FLAG	FLAG pin ($V_{CHARGE} - V_{BATT}$): open drain N-channel MOSFET that sinks current when the V_{CHARGE} voltage is higher than the V_{BATT} .
8	V_{CHARGE}	CHARGER SUPPLY pin: input pin when charge or precharge mode is selected; output pin when in reverse mode.

OPERATING MODE

CMD-PWM	CMD-MODE	Operating Function Selected
0	0	PRECHARGE MODE (Default state)
0	1	CHARGE MODE
1	0	CHARGE and PRECHARGE switches are open
1	1	CHARGE and PRECHARGE switches are open

I.C. BLOCK DIAGRAM

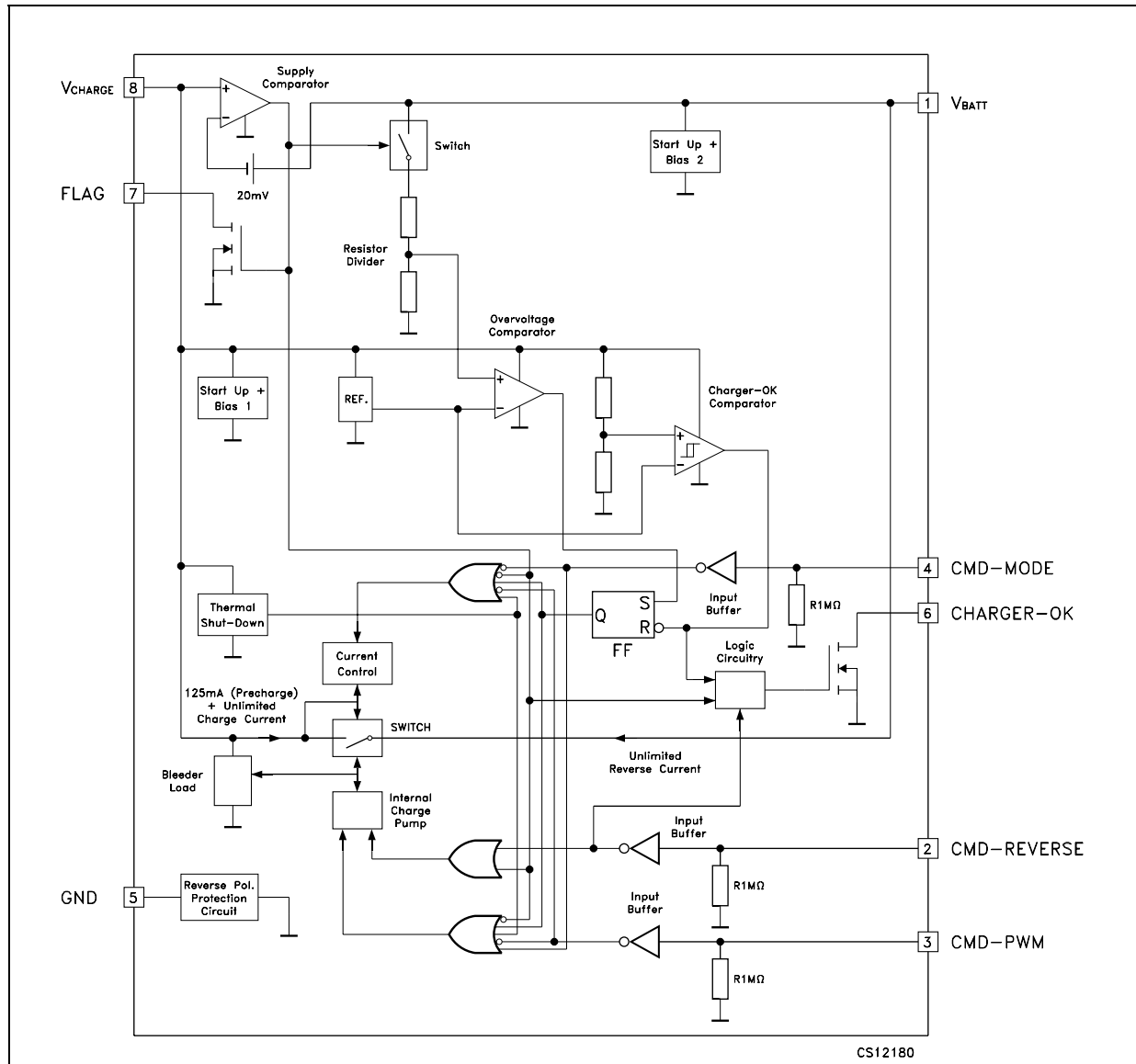

POSSIBLE OPERATING MODES

Five different operating modes are allowed: charge, precharge, reverse, charge+reverse and precharge+reverse. These operating modes can be achieved by properly selection of the CMD-REVERSE CMD-PWM and CMD-MODE (See POSSIBLE OPERATING MODE Table).

PRECHARGE MODE

The PRECHARGE function is composed by a switch and a 100mA current source which fully works for V_{CHARGE} higher than 2.5V. When the CMD-MODE and the CMD-PWM are not leaded the switch is ON, being the input states held by an internal pull down resistor. This is used when the

battery is strongly discharged. In this case V_{BATT} can be null (battery empty) and all the input pins are not held by any level (because the micro-controller is down), except the V_{CHARGE} pin which is a main supply. The source of current supplies a constant current into the battery till its voltage level reaches the required level allowing to start the micro-controller (typically 3V). The current direction is from V_{CHARGE} to V_{BATT} . The reverse leakage current when the switch is ON must be null; this is obtained thanks to an internal circuitry that switch OFF the internal P-MOS when the V_{BATT} is higher than V_{CHARGE} , whatever the status of the CMD-MODE. The precharge function is also used to adjust the mean current. When the

battery is fully charged the current into the battery has not to be more than $C/25$ (Nimh battery). In order to perform finely this, the CMD-PWM pin must be driven with PWM function (in the same time, the CMD-MODE must be kept low). The duty cycle allows to adjust the mean current needed.

CHARGE MODE

The CMD-MODE pin, when high (and CMD-PWM low), handles the switch in charge mode. This switch allows the battery charge with a strong current. The drop of this internal P-Channel MOS is very low (200mV @ 800mA) in order to optimize the efficiency of the charge.

The switch is not internally protected against short circuit or overcurrent condition.

When the switch is ON (CMD-MODE high and CMD-PWM low), the current direction into the chip is from V_{CHARGE} to V_{BATT} . The reverse current when the switch is ON must be null; this is obtained by mean of an internal circuitry that switch OFF the internal P-MOS when the V_{BATT} is higher than V_{CHARGE} , whatever the status of the CMD-MODE. When the CMD-MODE pin is low or in high impedance the switch is OFF, while it is ON when the signal on that pin is high.

REVERSE MODE

When the reverse function is selected by CDM-REVERSE pin, the switch allows to supply the accessories with a strong current. The drop of the internal P-Channel MOS is very low (200mV @ 800mA) and the switch properly work for V_{BATT} higher than 2.5V. This allows to supply energy on the V_{CHARGE} pin. When the switch is ON (CMD-REVERSE high) the current direction into the chip is from V_{BATT} to V_{CHARGE} .

The reverse current (from V_{CHARGE} to V_{BATT}) when the switch is ON must be null; this is obtained by mean of an internal circuitry that switch OFF the internal P-MOS when the V_{CHARGE} is higher than V_{BATT} , whatever the status of the CMD-REVERSE. When the level of CMD-REVERSE pin is low or in high impedance, the switch is OFF, while it is ON when the signal on CMD-REVERSE pin is high.

OVERVOLTAGE PROTECTION

This function allows to held the switches OFF when the voltage level on V_{BATT} is higher than a maximum voltage whatever are the values of CMD-PWM, CMD-MODE and CMD-REVERSE. This maximum voltage is shown in the electrical characteristic (typical threshold 5.7V). From the moment in which the o.v.protection is activated, it

will be possible to turn ON again the switch only when the V_{CHARGE} value decreases down to 2.5V typically, it doesn't matter which operation mode is selected. The protection works only when the battery is in charge or precharge mode, i.e. $V_{CHARGE} > V_{BATT}$. This represents, in fact, the typical application condition where the battery could increase its value, i.e. When charge or precharge mode are used.

CHARGER DETECTION MODE

This function allows to generate a digital signal (CHARGER-OK) to indicate if the V_{CHARGE} voltage is higher than 2.5V and the reverse function is inactive. This functionality allows to determine if the charger is present or not; if the V_{CHARGE} is lower than the 2.5V, the CHARGER-OK goes into high impedance (open drain). When the reverse function is active, this open drain have the $V_{CHARGE}-V_{BATT}$ information. This circuitry is directly supplied from V_{CHARGE} pin and works only for V_{CHARGE} higher than 2.2V.

$V_{CHARGE}-V_{BATT}$ DETECTION MODE

This function allows to generate a digital signal ($V_{CHARGE}-V_{BATT}$) flag to indicate if the V_{CHARGE} voltage is higher than V_{BATT} ; if the V_{CHARGE} is lower than the V_{BATT} , this open drain goes into high impedance state. This circuitry is directly supplied from V_{CHARGE} pin and works only for V_{CHARGE} higher than 2.2V.

THERMAL PROTECTION

An internal thermal shutdown circuitry will switch OFF the P_MOS, only in precharge or in charge mode, when the junction temperature reaches typically 180°C. This has been implemented in order to protect the device from overburning. 20°C of thermal hysteresis will avoid a thermal oscillation.

This circuitry is supplied from V_{CHARGE} and, so, acts only on the precharge and charge switches.

ESD PROTECTION

Both V_{CHARGE} and V_{BATT} pins are protected against electrostatic discharge up to ± 4 KV (HBM, MIL STD 833D).

CHARGE VOLTAGE

V_{CHARGE} functional operating range is from 2.5V to 12V. At $V_{CHARGE}=14$ V typically the I.C. is automatically turned OFF and remains OFF up to 16V. A V_{CHARGE} voltage higher than 16V can damage the IC.

POSSIBLE OPERATING MODE

CMD-PWM	CMD-MODE	CMD-REVERSE	Operating Function Selected
0	0	0	PRECHARGE
0	0	1	PRECHARGE + REVERSE
0	1	0	CHARGE
0	1	1	CHARGE + REVERSE
1	0	0	SWITCH OPEN
1	0	1	REVERSE
1	1	0	SWITCH OPEN
1	1	1	REVERSE

ELECTRICAL CHARACTERISTICS OF REVERSE SWITCH ($T_A = -40$ to 85°C , unless otherwise specified.)

Symbol	Parameter	Test Conditions	Min.	Typ.	Max.	Unit
V_{BATT}	Reverse Block Operating Input Voltage		2.5		6	V
V_{DROP}	Dropout Voltage	$V_{BATT}=3V$ $I_{REVERSE}=800mA$ $V_{CMD-REVERSE}=1.9V$, $V_{CMD-PWM}=1.9V$ $V_{CMD-MODE}=1.9V$		130	200	mV
$I_{LEAKAGE}$	Reverse Leakage Current (from V_{CHARGE} to V_{BATT} , tested on V_{BATT} pin)	$V_{BATT}=0V$ $V_{CHARGE}=9V$ $V_{CMD-REVERSE}=1.9V$, $V_{CMD-PWM}=1.9V$ $V_{CMD-MODE}=1.9V$		0	1	μA
V_{IH}	CMD-REVERSE Logic High (Switch ON)	$V_{BATT}=3V$ $I_{REVERSE}=10mA$ $V_{CMD-PWM}=1.9V$ $V_{CMD-MODE}=1.9V$	1.2			V
V_{IL}	CMD-REVERSE Logic Low (Switch OFF)	$V_{BATT}=3V$ $I_{REVERSE}=10mA$ $V_{CMD-PWM}=1.9V$ $V_{CMD-MODE}=1.9V$			0.4	V
V_{TH}	CMD-REVERSE Logic Typical Threshold	$V_{BATT}=3V$ $I_{REVERSE}=10mA$ $V_{CMD-PWM}=1.9V$ $V_{CMD-MODE}=1.9V$		0.75		V
$I_{CMD-REV}$	CMD-REV Input Current	$V_{BATT}=3V$ $I_{REVERSE}=10mA$ $V_{CMD-REVERSE}=1.9V$, $V_{CMD-PWM}=1.9V$ $V_{CMD-MODE}=1.9V$	1	1.9	3	μA
		$V_{BATT}=5V$ $I_{REVERSE}=10mA$ $V_{CMD-REVERSE}=1.9V$, $V_{CMD-PWM}=1.9V$ $V_{CMD-MODE}=1.9V$			10	μA
t_{ON-OFF}	Response Time			100		μs

ELECTRICAL CHARACTERISTICS OF PRECHARGE SWITCH ($T_A = -40$ to 85°C , unless otherwise specified.)

Symbol	Parameter	Test Conditions	Min.	Typ.	Max.	Unit
V_{CHARGE}	Precharge Block Operating Input Voltage		2.5		12	V
V_{DROP}	Dropout Voltage	$V_{\text{CHARGE}} = 2.5\text{V to }9\text{V}$ $I_{\text{PRECHARGE}} = 100\text{mA}$ $V_{\text{CMD-REVERSE}} = 0\text{V or floating}$ $V_{\text{CMD-PWM}} = 0\text{V or floating}$ $V_{\text{CMD-MODE}} = 0\text{V or floating}$		0.13	1.2	V
$I_{\text{PRECHARGE}}$	Precharge Current Limit (from V_{CHARGE} to V_{BATT})	$V_{\text{CHARGE}} = 2.5\text{V to }5\text{V}$ $V_{\text{BATT}} = 0\text{V}$ $V_{\text{CMD-REVERSE}} = 0\text{V or floating}$ $V_{\text{CMD-PWM}} = 0\text{V or floating}$ $V_{\text{CMD-MODE}} = 0\text{V or floating}$	100		170	mA
		$V_{\text{CHARGE}} = 2.5\text{V to }9\text{V}$ $V_{\text{BATT}} = 0\text{V}$ $V_{\text{CMD-REVERSE}} = 0\text{V or floating}$ $V_{\text{CMD-PWM}} = 0\text{V or floating}$ $V_{\text{CMD-MODE}} = 0\text{V or floating}$	100		200	
I_{LEAKAGE}	Precharge Leakage Current Limit (from V_{BATT} to V_{CHARGE} , tested on V_{CHARGE} pin)	$V_{\text{CHARGE}} = 0\text{V}$ $V_{\text{BATT}} = 5.5\text{V}$ $V_{\text{CMD-REVERSE}} = 0\text{V or floating}$ $V_{\text{CMD-PWM}} = 0\text{V or floating}$ $V_{\text{CMD-MODE}} = 0\text{V or floating}$			1	μA
F_{MODE}	PRECHARGE Switch Minimum Frequency	$V_{\text{CHARGE}} = 2.5\text{V to }9\text{V}$ $V_{\text{BATT}} = 0\text{V to }V_{\text{CHARGE}}$ $V_{\text{CMD-REVERSE}} = 0\text{V or floating}$ $V_{\text{CMD-PWM}} = 0\text{V or floating}$ $V_{\text{CMD-MODE}} = 0\text{V to }1.9\text{V at }F_{\text{MODE}}$	100			Hz
$t_{\text{ON-OFF}}$	Response Time			100		μs
$t_{\text{OFF-ON}}$	Response Time			100		μs

ELECTRICAL CHARACTERISTICS OF CHARGE SWITCH ($T_A = -40$ to 85°C , unless otherwise specified.)

Symbol	Parameter	Test Conditions	Min.	Typ.	Max.	Unit
V_{CHARGE}	Charge Block Operating Input Voltage		2.5		12	V
V_{DROP}	Dropout Voltage	$V_{\text{CHARGE}} = 2.5\text{V to }5\text{V}$ $I_{\text{CHARGE}} = 800\text{mA}$ $V_{\text{CMD-REVERSE}} = 0\text{V}$ $V_{\text{CMD-PWM}} = 0\text{V}$ $V_{\text{CMD-MODE}} = 1.9\text{V}$		0.13	0.2	V
I_{LEAKAGE}	Precharge Leakage Current Limit (from V_{BATT} to V_{CHARGE} , tested on V_{CHARGE} pin)	$V_{\text{CHARGE}} = 0\text{V}$ $V_{\text{BATT}} = 5.5\text{V}$ $V_{\text{CMD-REVERSE}} = 0\text{V}$ $V_{\text{CMD-PWM}} = 0\text{V}$ $V_{\text{CMD-MODE}} = 1.9\text{V}$			1	μA
V_{IH}	CMD-MODE Logic High (CHARGE MODE ON)	$V_{\text{CHARGE}} = 2.5\text{V to }5\text{V}$ $I_{\text{CHARGE}} = 10\text{mA}$ $V_{\text{CMD-REVERSE}} = 0\text{V}$ $V_{\text{CMD-PWM}} = 0\text{V}$	1.2			V
V_{IL}	CMD-MODE Logic Low (CHARGE MODE OFF)	$V_{\text{CHARGE}} = 2.5\text{V to }5\text{V}$ $I_{\text{CHARGE}} = 10\text{mA}$ $V_{\text{CMD-REVERSE}} = 0\text{V}$ $V_{\text{CMD-PWM}} = 0\text{V}$			0.4	V
V_{TH}	CMD-MODE Logic Typical Threshold	$V_{\text{CHARGE}} = 2.5\text{V to }5\text{V}$ $I_{\text{CHARGE}} = 10\text{mA}$ $V_{\text{CMD-REVERSE}} = 0\text{V}$ $V_{\text{CMD-PWM}} = 0\text{V}$		0.75		V
$I_{\text{CMD-REV}}$	CMD-MODE Input Current	$V_{\text{CHARGE}} = 3\text{V to }5\text{V}$ $I_{\text{CHARGE}} = 10\text{mA}$ $V_{\text{CMD-REVERSE}} = 0\text{V}$ $V_{\text{CMD-PWM}} = 0\text{V}$ $V_{\text{CMD-MODE}} = 1.9\text{V}$	1		30	μA
F_{MODE}	PRECHARGE Switch Minimum Frequency	$V_{\text{CHARGE}} = 2.5\text{V to }5\text{V}$ $I_{\text{CHARGE}} = 10\text{mA}$ $V_{\text{CMD-REVERSE}} = 0\text{V}$ $V_{\text{CMD-PWM}} = 0\text{V}$ $V_{\text{CMD-MODE}} = 0\text{V to }1.9\text{V at }F_{\text{MODE}}$	100			Hz
$t_{\text{ON-OFF}}$	Response Time			100		μs

ELECTRICAL CHARACTERISTICS OF CMD-PWM LOGIC PIN ($T_A = -40$ to 85°C , $V_{\text{CHARGE}} = 2.5$ to 9V unless otherwise specified.)

Symbol	Parameter	Test Conditions	Min.	Typ.	Max.	Unit
V_{IH}	CMD-PWM Logic High (SWITCH OFF)	$I_{\text{PRECHARGE}} = 10\text{mA}$ $V_{\text{CMD-REVERSE}} = 0\text{V}$ $V_{\text{CMD-MODE}} = 0\text{V}$	1.2			V
V_{IL}	CMD-PWM Logic High (SWITCH ON)	$I_{\text{PRECHARGE}} = 10\text{mA}$ $V_{\text{CMD-REVERSE}} = 0\text{V}$ $V_{\text{CMD-MODE}} = 0\text{V}$			0.4	V
V_{TH}	CMD-PWM Logic Typical Threshold	$I_{\text{PRECHARGE}} = 10\text{mA}$ $V_{\text{CMD-REVERSE}} = 0\text{V}$ $V_{\text{CMD-MODE}} = 0\text{V}$		0.75		V
$I_{\text{CMD-PWM}}$	CMD-PWM Input Current	$I_{\text{PRECHARGE}} = 10\text{mA}$ $V_{\text{CMD-REVERSE}} = 0\text{V}$ $V_{\text{CMD-MODE}} = 0\text{V}$ $V_{\text{CMD-MODE}} = 1.9\text{V}$	1		30	μA

ELECTRICAL CHARACTERISTICS OF CHARGER DETECTION BLOCK ($T_A = -40$ to 85°C , $V_{\text{CHARGE}} = 2.2$ to 9V , $V_{\text{CMD-REVERSE}} = 0\text{V}$ or floating unless otherwise specified.)

Symbol	Parameter	Test Conditions	Min.	Typ.	Max.	Unit
V_{CHARGE}	Charger Detection Block Operating Input Voltage		2.2			V
$V_{\text{CHARGE-TH}}$	Low Voltage Threshold	with falling edge	2.425	2.5	2.575	V
$V_{\text{CHARGE-HYS}}$	Low Voltage Hysteresis	with rising edge, $T_A=25^\circ\text{C}$		100		mV
$V_{\text{CHARGER-OK}}$	CHARGER-OK Output Voltage Low	$V_{\text{CHARGE}}=3\text{V}$ $I_{\text{CHARGER-OK}}=1\text{mA}$		0.2	0.4	V
$V_{\text{CHARGER-OK}}$	CHARGER-OK Output Voltage Low	$V_{\text{FLAG}}=0.2\text{V}$ $I_{\text{CHARGER-OK}}=1\text{mA}$ $V_{\text{CMD-REVERSE}}=1.9\text{V}$		0.2	0.4	V
$I_{\text{CHARGER-OK}}$	CHARGER-OK Output Leakage Current	$V_{\text{CHARGE}}=2.2\text{V}$ $V_{\text{CHARGER-OK}}=10\text{V}$		0	1	μA
$I_{\text{CHARGER-OK}}$	CHARGER-OK Output Leakage Current	$V_{\text{FLAG}}=0.2\text{V}$ $V_{\text{CHARGER-OK}}=10\text{V}$ $V_{\text{CMD-REVERSE}}=1.9\text{V}$		0	1	μA

ELECTRICAL CHARACTERISTICS OF FLAG DETECTION BLOCK ($T_A = -40$ to 85°C , $V_{\text{CHARGE}} = 2.2$ to 9V unless otherwise specified.)

Symbol	Parameter	Test Conditions	Min.	Typ.	Max.	Unit
V_{CHARGE}	FLAG Detection Block Operating Input Voltage		2.2			V
$V_{\text{VCHARGE-VBATT}}$	FLAG ($V_{\text{CHARGE}} - V_{\text{BATT}}$) Voltage Low	$V_{\text{FLAG}}=0.2\text{V}$ $I_{\text{FLAG}}=1\text{mA}$		0.2	0.45	V
$I_{\text{VCHARGE-VBATT}}$	FLAG ($V_{\text{CHARGE}} - V_{\text{BATT}}$) Leakage Current	$V_{\text{FLAG}}=0.2\text{V}$ $I_{\text{FLAG}}=10\text{mA}$			1	μA
$V_{\text{VCHARGE-VBATT}}$	FLAG* ($V_{\text{CHARGE}} - V_{\text{BATT}}$) Voltage Low	$I_{\text{CHARGE}}=20\text{mA}$ $I_{\text{FLAG}}=1\text{mA}$		0.2	0.45	V
$I_{\text{VCHARGE-VBATT}}$	FLAG* ($V_{\text{CHARGE}} - V_{\text{BATT}}$) Leakage Current	$V_{\text{BATT}} = V_{\text{CHARGE}}$ $V_{\text{FLAG}}=10\text{V}$			1	μA

* Guaranteed by design

ELECTRICAL CHARACTERISTICS OF OVERLOAD PROTECTION ($T_A = -40$ to 85°C , $V_{\text{CHARGE}} > 3\text{V}$, $V_{\text{CHARGE}} > V_{\text{BATT}}$, $V_{\text{CMD-REVERSE}}=0\text{V}$, $V_{\text{CMD-PWM}}=0\text{V}$, $V_{\text{CMD-MODE}}=0\text{V}$ to 1.9V , unless otherwise specified.)

Symbol	Parameter	Test Conditions	Min.	Typ.	Max.	Unit
V_{BATT}	Battery Input Threshold	with rising edge	5.4	5.6	5.9	V
$t_{\text{ON-OFF}}$	Response Time	Switches ON to OFF, $T_A = 25^\circ\text{C}$		100		μs

I.C. CONSUMPTION ($T_A = -40$ to 85°C , $V_{\text{CHARGE}} < V_{\text{BATT}}$, unless otherwise specified.)

Symbol	Parameter	Test Conditions	Min.	Typ.	Max.	Unit
I_{BATT}	Current Consumption from Battery Pin	$V_{\text{CMD-PWM}}=1.9\text{V}$ $V_{\text{CMD-MODE}}=0\text{V}$ or 1.9V				μA
		$V_{\text{BATT}}= 3$ to 5.25V $V_{\text{CHARGE}}=$ floating $V_{\text{CMD-REVERSE}}=0\text{V}$			15	μA
		$V_{\text{BATT}}= 5.25\text{V}$ $V_{\text{CHARGE}}=$ floating $V_{\text{CMD-REVERSE}}=1.9\text{V}$		140	300	μA
I_{CHARGE}	Current Consumption from the Charge Pin	$V_{\text{CHARGE}}= 5.25\text{V}$ $V_{\text{BATT}}=$ floating $V_{\text{CMD-REVERSE}}=0\text{V}$ $V_{\text{CMD-PWM}}=1.9\text{V}$ $V_{\text{CMD-MODE}}=0\text{V}$ or 1.9V		78	250	μA

ESD PROTECTION

Symbol	Parameter	Test Conditions	Min.	Typ.	Max.	Unit
ESD	Electrostatic Discharge Immunity for V_{CHARGE} and V_{BATT} pins	$T_A=25^\circ\text{C}$ Human Body Method MIL STD 833D-3015.7		± 4		kV

TYPICAL PERFORMANCE CHARACTERISTICS (unless otherwise specified $T_j = 25^\circ\text{C}$)

Figure 1 : Precharge Current Limit vs Temperature

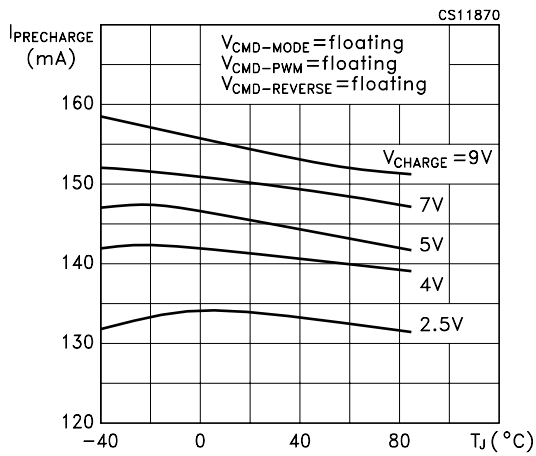

Figure 2 : Charge Drop Voltage vs Temperature

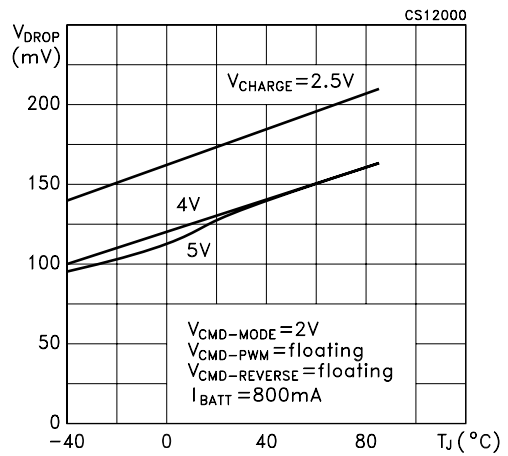

Figure 3 : Current Consumption vs Temperature

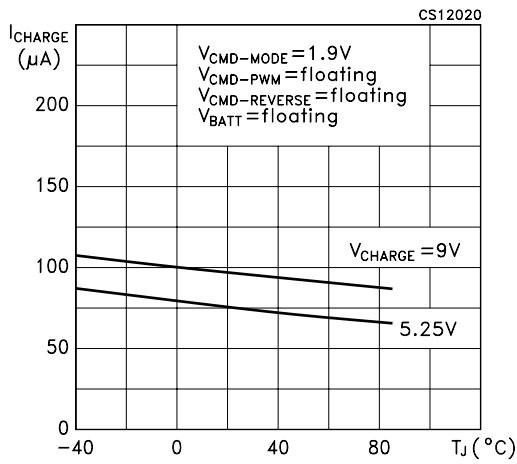

Figure 6 : V_{BATT} Leakage Current vs Temperature

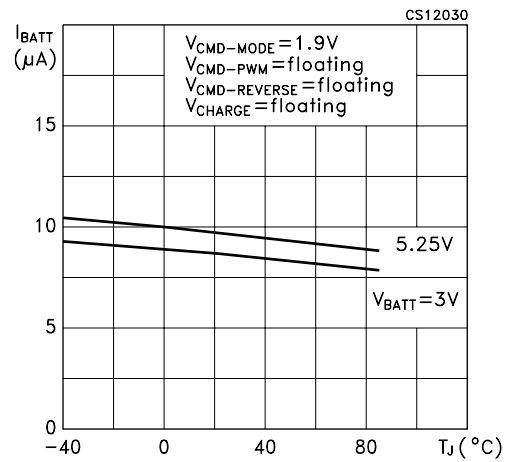

Figure 4 : Precharge Drop Voltage vs Temperature

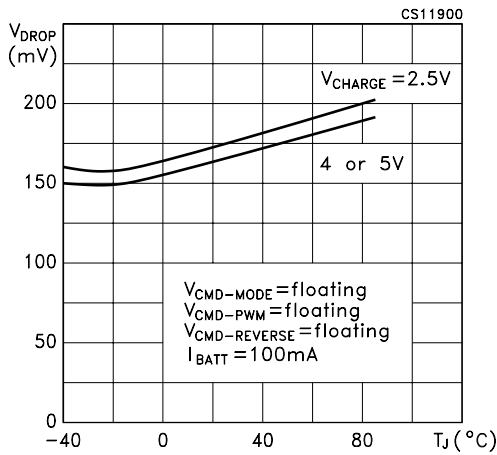

Figure 7 : Reverse Current Consumption vs Temperature

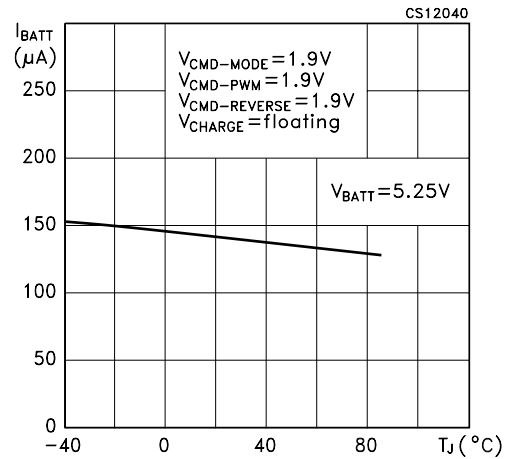

Figure 5 : Reverse Drop Voltage vs Temperature

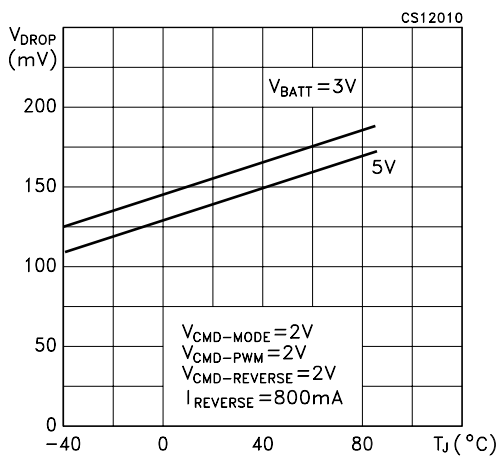

Figure 8 : CMD-Mode Logic Threshold vs Temperature

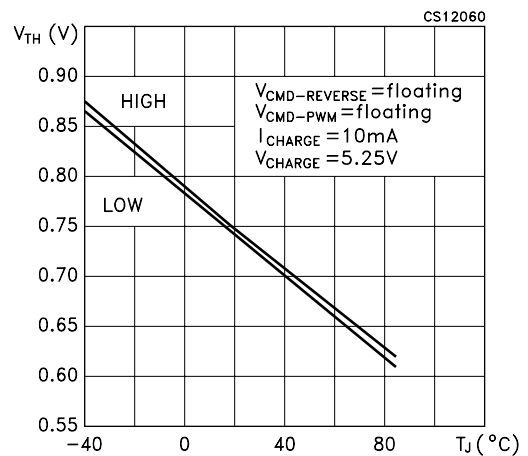

Figure 9 : Command PWM Logic Threshold vs Temperature

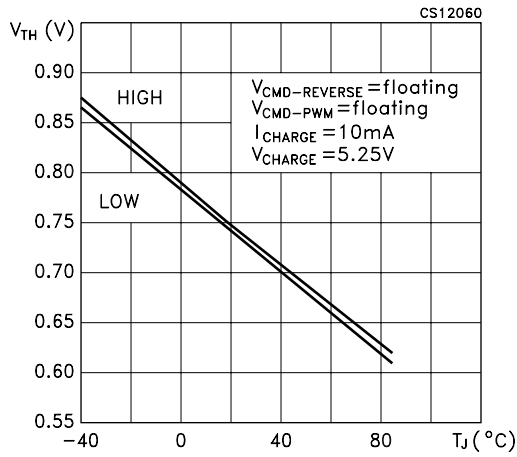

Figure 12 : CMD-REVERSE Input Current vs Temperature

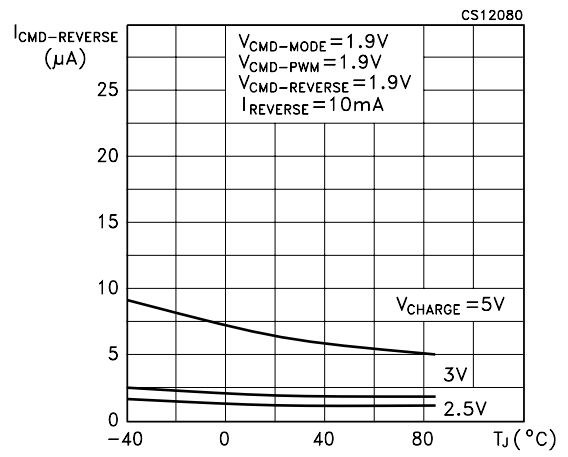

Figure 10 : CMD-MODE Input Current vs Temperature

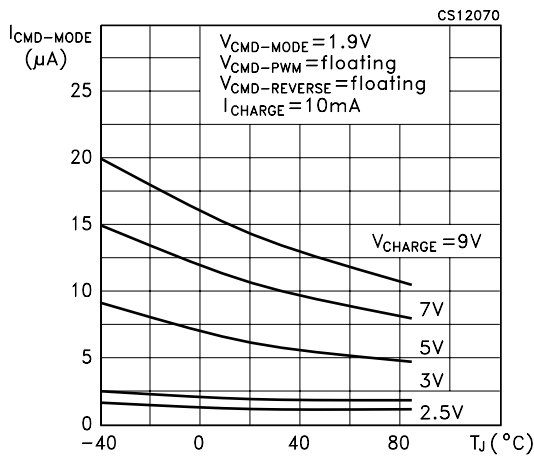

Figure 13 : CMD-PWM Input Current vs Temperature

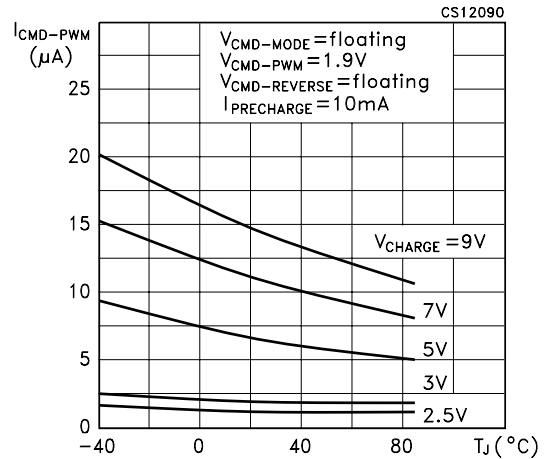

Figure 11 : Command Reverse Logic vs Temperature

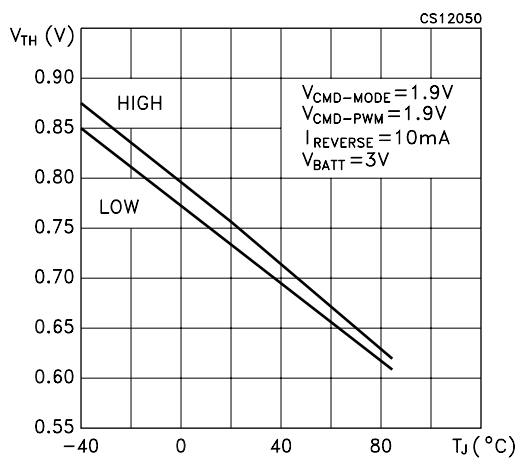

Figure 14 : CHARGER OK Voltage vs Temperature

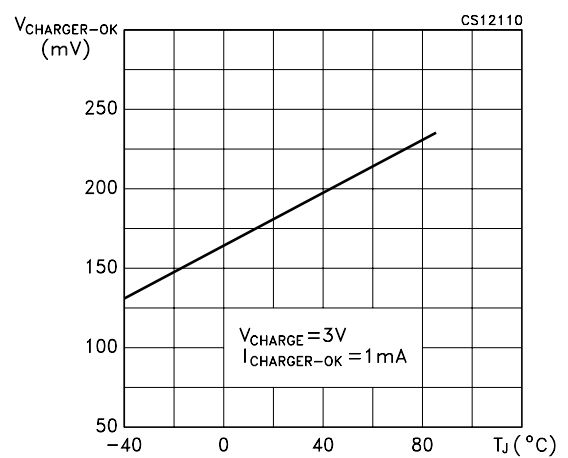

Figure 15 : CHARGER OK Voltage vs Temperature

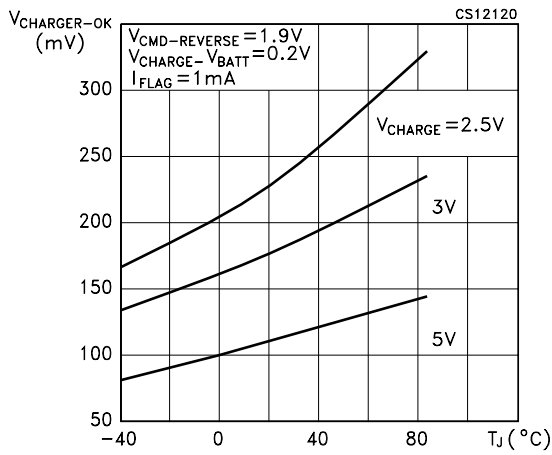

Figure 18 : Minimum Battery Current vs Temperature

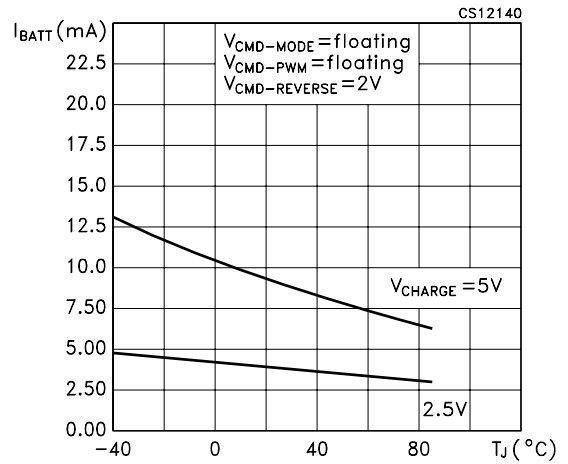

Figure 16 : CHARGER OK Voltage Threshld vs Temperature

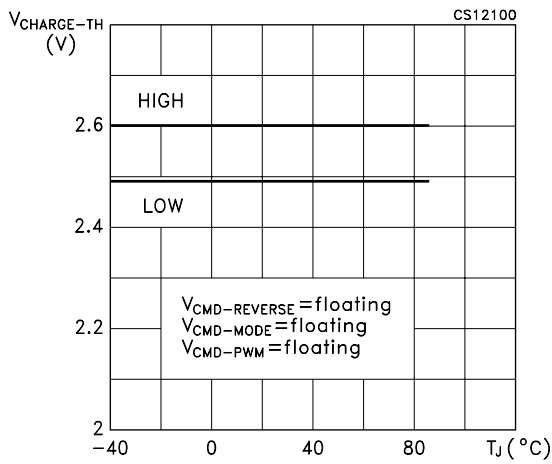

Figure 19 : Minimum Battery Current vs Temperature

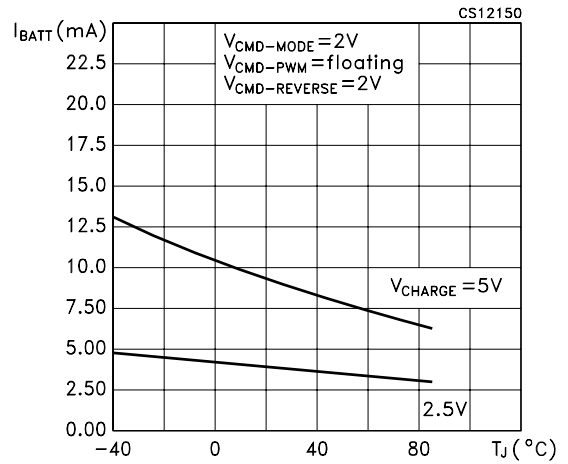

Figure 17 : Flag Voltage Low vs Temperature

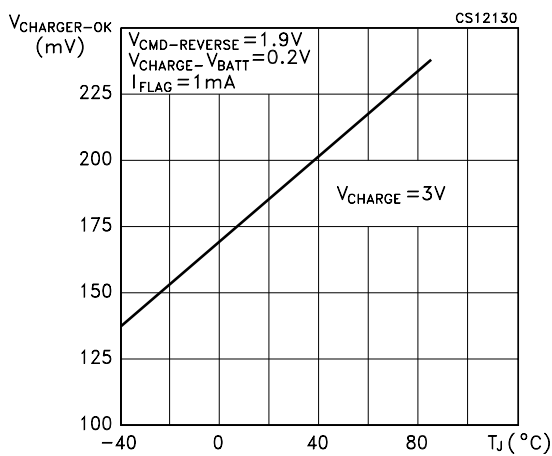

Figure 20 : Overvoltage Protection vs Temperature

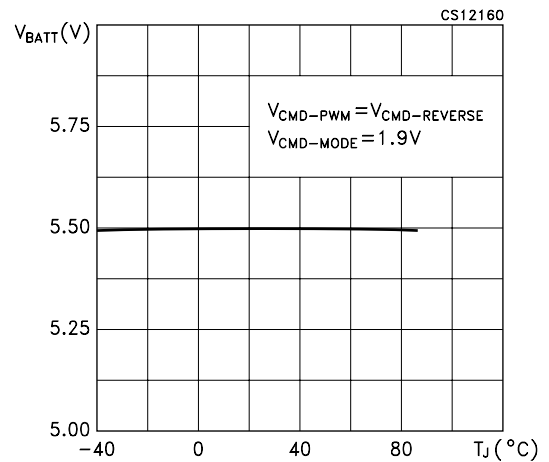
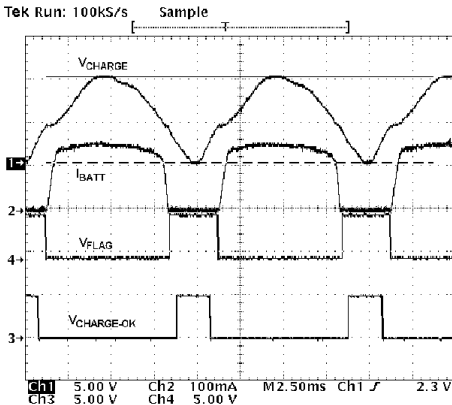
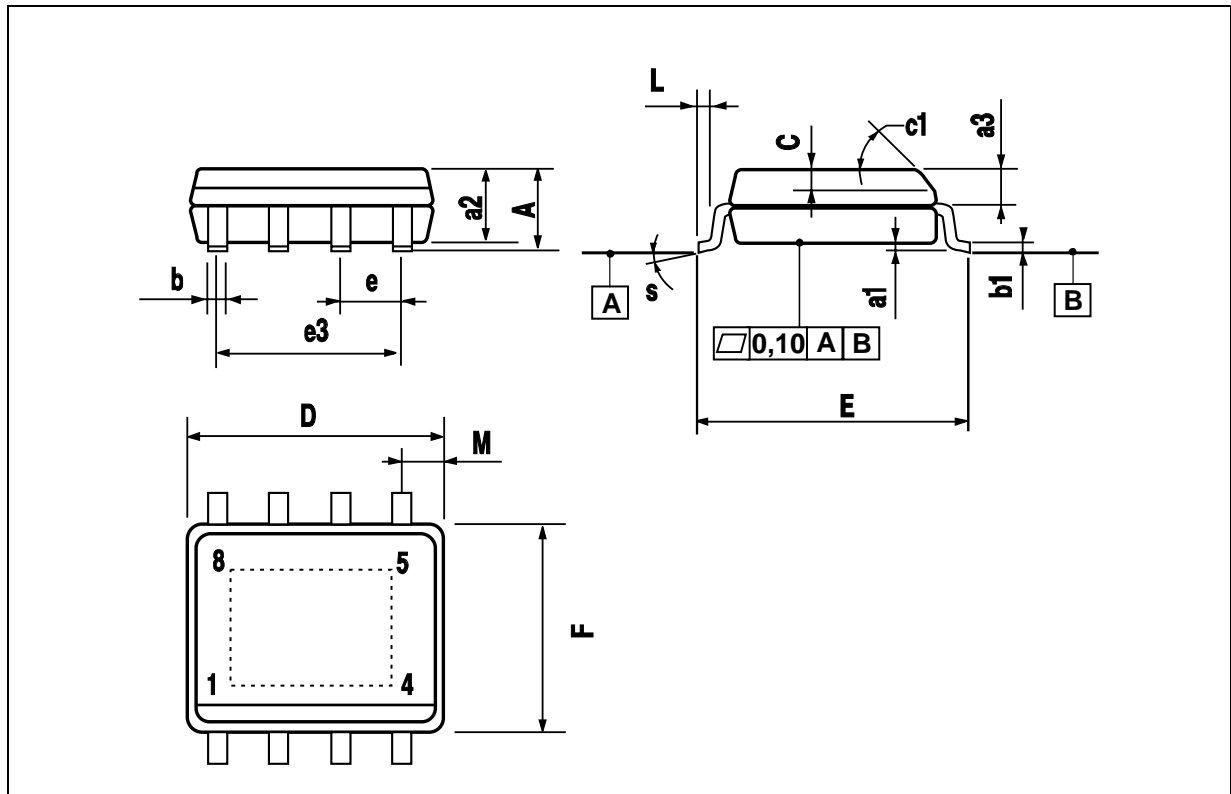

Figure 21 : Dynamic Precharge Mode



SO-8 (exposed pad) MECHANICAL DATA

DIM.	mm.			inch		
	MIN.	TYP.	MAX.	MIN.	TYP.	MAX.
A	1.25		1.62	0.049		0.064
a1	0		0.10	0.000		0.004
a2	1.10		1.65	0.043		0.064
a3	0.65		0.85	0.025		0.033
b	0.33		0.51	0.013		0.020
b1	0.19		0.25	0.007		0.010
C	0.25		0.50	0.010		0.019
c1	45° (max.)					
D	4.80		5.00	0.189		0.196
E	5.80		6.20	0.228		0.244
e		1.27			0.050	
e3		3.81			0.150	
F	3.80		4.00	0.149		0.157
L	0.40		1.27	0.016		0.050
M			0.6			0.023
S	8° (max.)					



Tape & Reel SO-8 MECHANICAL DATA

DIM.	mm.			inch		
	MIN.	TYP	MAX.	MIN.	TYP.	MAX.
A			330			12.992
C	12.8		13.2	0.504		0.519
D	20.2			0.795		
N	60			2.362		
T			22.4			0.882
Ao	8.1		8.5	0.319		0.335
Bo	5.5		5.9	0.216		0.232
Ko	2.1		2.3	0.082		0.090
Po	3.9		4.1	0.153		0.161
P	7.9		8.1	0.311		0.319

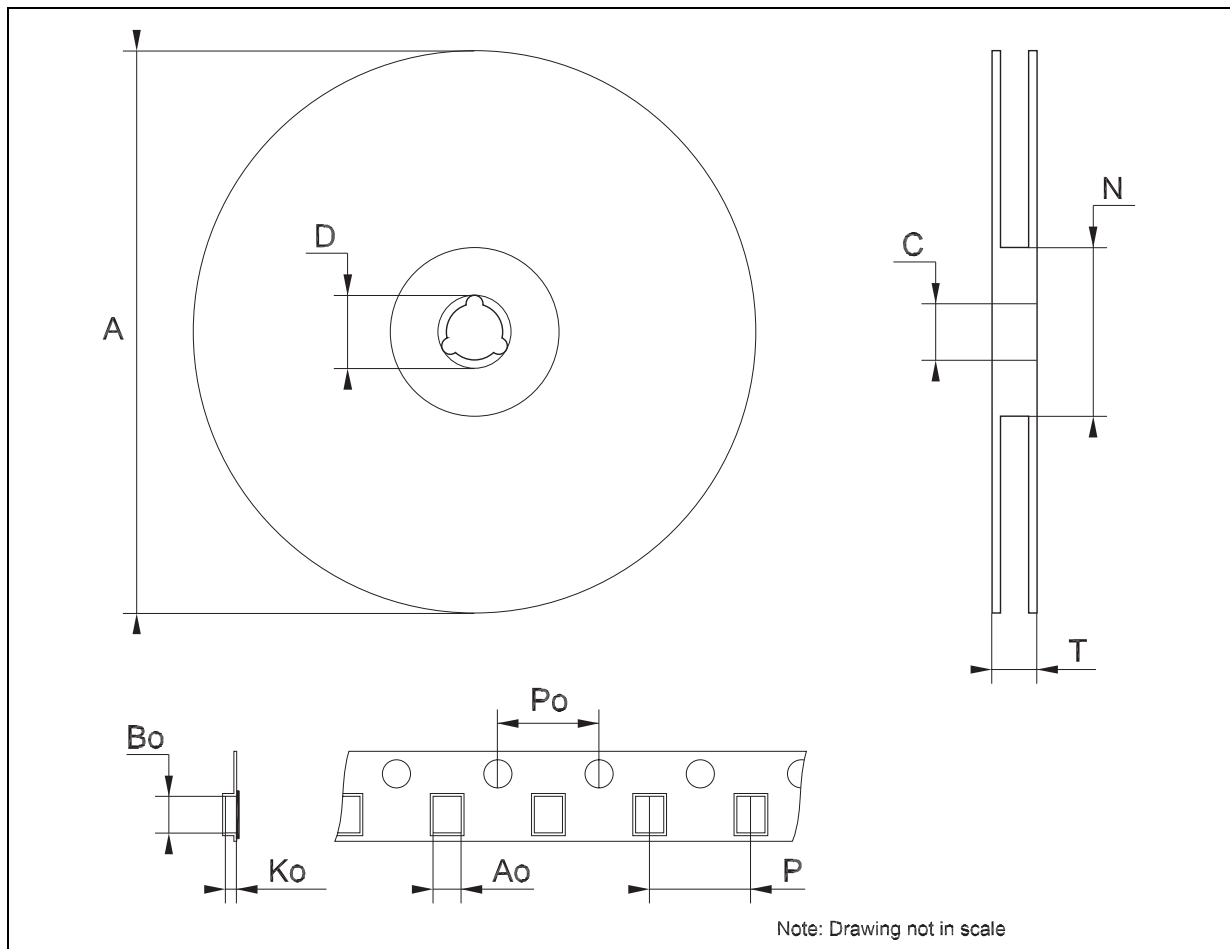

Information furnished is believed to be accurate and reliable. However, STMicroelectronics assumes no responsibility for the consequences of use of such information nor for any infringement of patents or other rights of third parties which may result from its use. No license is granted by implication or otherwise under any patent or patent rights of STMicroelectronics. Specifications mentioned in this publication are subject to change without notice. This publication supersedes and replaces all information previously supplied. STMicroelectronics products are not authorized for use as critical components in life support devices or systems without express written approval of STMicroelectronics.

© The ST logo is a registered trademark of STMicroelectronics

© 2003 STMicroelectronics - Printed in Italy - All Rights Reserved
STMicroelectronics GROUP OF COMPANIES

Australia - Brazil - Canada - China - Finland - France - Germany - Hong Kong - India - Israel - Italy - Japan - Malaysia - Malta - Morocco
Singapore - Spain - Sweden - Switzerland - United Kingdom - United States.

© <http://www.st.com>

