

Electroluminescent Lamp Driver

- 2.2V-5.0V Battery Operation
- 50nA Typical Standby Current
- High Voltage Output 160 V_{pp} typical
- Internal Oscillator

APPLICATIONS

- PDAs
- Cellular Phones
- Remote Controls
- Handheld Computers

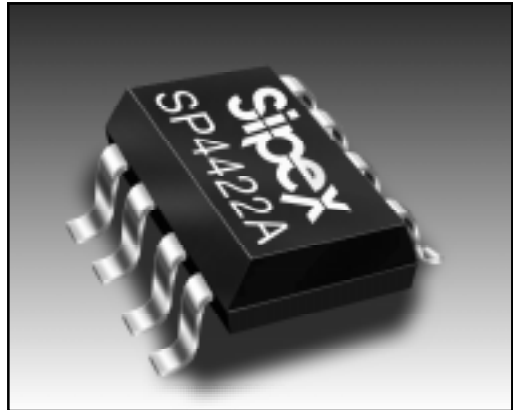

DESCRIPTION

The **SP4422A** is a high voltage output DC-AC converter that can operate from a 2.2V-5.0V power supply. The **SP4422A** is capable of supplying up to 220 V_{pp} signals, making it ideal for driving electroluminescent lamps. The device features 50 nA (typical) standby current, for use in low power portable products. One external inductor is required to generate the high voltage, and one external capacitor is used to select the oscillator frequency. The **SP4422A** is offered in an 8-pin narrow and 8-pin micro SOIC packages. For delivery in die form, please consult the factory.

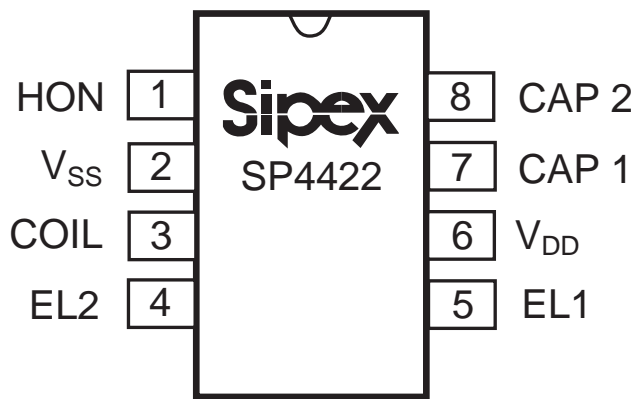

SP4422A Block Diagram

ABSOLUTE MAXIMUM RATINGS

These are stress ratings only and functional operation of the device at these ratings or any other above those indicated in the operation sections of the specifications below is not implied. Exposure to absolute maximum rating conditions for extended periods of time may affect reliability.

V _{DD}	7.0V
Input Voltages/Currents	
HON (pin1).....	-0.5V to (V _{DD} +0.5V)
COIL (pin3).....	60mA
Lamp Outputs.....	230V _{PP}
Storage Temperature.....	-65°C to +150°C

Power Dissipation Per Package

8-pin NSOIC (derate 6.14mW/°C above +70°C).....	500mW
8-pin μSOIC (derate 4.85mW/°C above +70°C).....	390mW

The information furnished herein by Sipex has been carefully reviewed for accuracy and reliability. Its application or use, however, is solely the responsibility of the user. No responsibility for the use of this information is assumed by Sipex, and this information shall not explicitly or implicitly become part of the terms and conditions of any subsequent sales agreement with Sipex. Specifications are subject to change without prior notice. By the sale or transfer of this information, Sipex assumes no responsibility for any infringement of patents or other rights of third parties which may result from its use. No license or other proprietary rights are granted by implication or otherwise under any patent or patent rights of Sipex Corporation.

SPECIFICATIONS

(T = 25°C; V_{DD} = 3.0V; Lamp Capacitance = 17nF with 100Ω Series resistor; Coil = 5mH (R_S = 18Ω); C_{OSC} = 100pF unless otherwise noted)

PARAMETER	MIN.	TYP.	MAX.	UNITS	CONDITIONS
Supply Voltage, V _{DD}	2.2	3.0	5.0	V	
Supply Current, I _{COIL} +I _{DD}		20 40	30 60	mA	V _{DD} =3.0V, V _{HON} =3.0V V _{DD} =5.0V, V _{HON} =5.0V
Coil Voltage, V _{COIL}	V _{DD}		5.0	V	
HON Input Voltage, V _{HON} LOW: EL off HIGH: EL on	-0.25 V _{DD} -0.25	0 V _{DD}	0.25V V _{DD} +0.25	V	
HON Current, EL on		25	60	μA	V _{DD} ≤V _{HON} ≤3V
Shutdown Current, I _{SD} =I _{COIL} +I _{DD}		50 0.3	500	nA μA	V _{DD} =3.0V, V _{HON} =LOW V _{DD} =5.0V, V _{HON} =LOW
INDUCTOR DRIVE					
Coil Frequency, f _{COIL} =f _{LAMP} ×32		11.2		kHz	
Coil Duty Cycle		94		%	
Peak Coil Current, I _{PK-COIL}			60	mA	Guaranteed by design.
EL LAMP OUTPUT					
EL Lamp Frequency, f _{LAMP}	250 200	352	450 600	Hz	T _{AMB} =+25°C, V _{DD} =3.0V T _{AMB} =-40°C to +85°C, V _{DD} =3.0V
Peak to Peak Output Voltage	60 70 110 180	80 140 200		V _{PP}	T _{AMB} =+25°C, V _{DD} =2.2V T _{AMB} =-40°C to +85°C, V _{DD} =3.0V T _{AMB} =+25°C, V _{DD} =3.0V T _{AMB} =+25°C, V _{DD} =5.0V

This data sheet specifies environmental parameters, final test conditions and limits as well suggested operating conditions. For applications which require performance beyond the specified conditions and or limits please consult the factory.

Bonding Diagram:

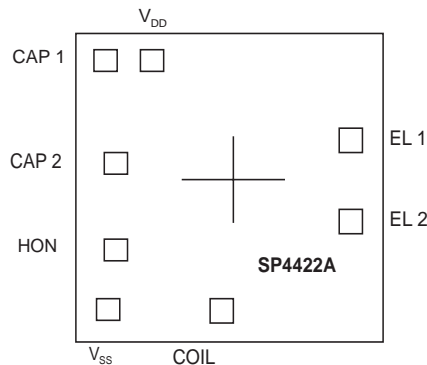

PAD	X	Y
EL1	556.5	179.0
EL2	556.2	-151.0
COIL	-19.5	-517.0
V _{SS}	-568.0	-517.0
HON	-549.0	-256.5
CAP2	-549.0	93.5
CAP1	-568.0	-516.5
V _{DD}	-349.0	517.0

NOTES:

- Dimensions are in Microns unless otherwise noted.
- Bonding pads are 125x125 typical
- Outside dimensions are maximum, including scribe area.
- Die thickness is 10mils +/- 1.
- Pad center coordinates are relative to die center.
- Die size 1447 x 1346 (57 x 53 mils).

PIN DESCRIPTION

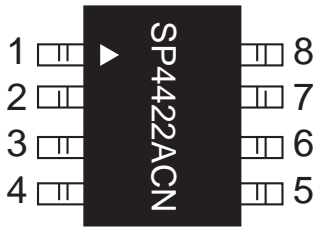

Pin 1 – HON- Enable for driver operation, high = active; low = inactive.

Pin 2 – V_{SS} - Power supply common, connect to ground.

Pin 3 – Coil- Coil input, connect coil from V_{DD} to pin 3.

Pin 4 – Lamp- Lamp driver output2, connect to EL lamp.

Pin 5 – Lamp- Lamp driver output1, connect to EL lamp.

Pin 6 – V_{DD} - Power supply for driver, connect to system V_{DD} .

Pin 7 – Cap1- Capacitor input 1, connect to C_{OSC} .

Pin 8 – Cap2- Capacitor input 2, connect to C_{OSC} .

THEORY OF OPERATION

The **SP4422A** is made up of three basic circuit elements, an oscillator, coil, and switched H-bridge network. The oscillator provides the device with an on-chip clock source used to control the charge and discharge phases for the coil and lamp. An external capacitor connected between pins 7 and 8 allows the user to vary the oscillator frequency from 32kHz to 400kHz. The graphs on page 6 show the relationship between C_{OSC} and lamp output voltage. In general, increasing the C_{OSC} capacitor will increase the lamp output.

The suggested oscillator frequency is 90kHz ($C_{OSC}=100\text{pF}$). The oscillator output is internally divided to create two internal control signals, f_{COIL} and f_{LAMP} . The oscillator output is internally divided down by 8 flip flops, a 90kHz signal will be divided into 8 frequencies; 45kHz, 22.5kHz, 11.2kHz, 5.6kHz, 2.8kHz, 1.4kHz, 703Hz, and 352Hz. The third flip flop output (8kHz) is used to drive the coil (see **figure 2** on **page 9**) and the eighth flip flop output (250Hz) is used to drive the lamp. Although the oscillator frequency can be varied to optimize the lamp output, the ratio of f_{COIL}/f_{LAMP} will always equal 32.

The on-chip oscillator of the **SP4422A** can be overdriven with an external clock source by removing the C_{OSC} capacitor and connecting a

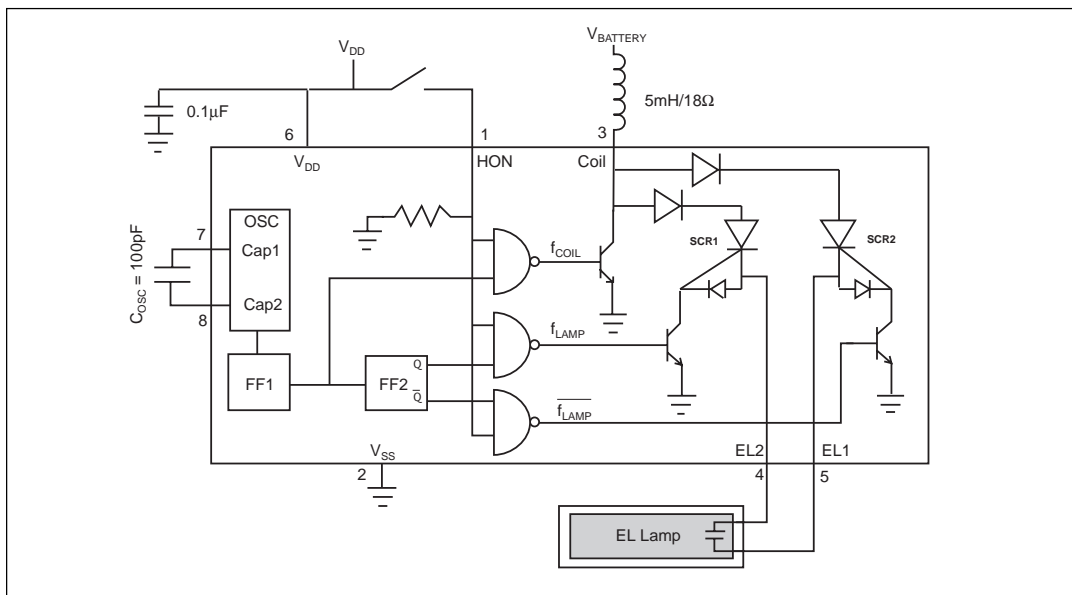

SP4422A Schematic

clock source to pin 8. The clock should have a 50% duty cycle and range from $V_{DD} - 1V$ to ground. An external clock signal may be desirable in order to synchronize any parasitic switching noise with the system clock. The maximum external clock frequency that can be supplied is 400kHz.

The coil is an external component connected from $V_{BATTERY}$ to pin 3 of the **SP4422A**. Energy is stored in the coil according to the equation $E_L = 1/2LI^2$, where I is the peak current flowing in the inductor. The current in the inductor is time dependent and is set by the "ON" time of the coil switch: $I = (V_L / L)t_{ON}$, where V_L is the voltage across the inductor. At the moment the switch closes, the current in the inductor is zero and the entire supply voltage (minus the V_{SAT} of the switch) is across the inductor. The current in the inductor will then ramp up at a linear rate. As the current in the inductor builds up, the voltage across the inductor will decrease due to the resistance of the coil and the "ON" resistance of the switch: $V_L = V_{BATTERY} - I R_L - V_{SAT}$. Since the voltage across the inductor is decreasing, the current ramp-rate also decreases which reduces the current in the coil at the end of t_{ON} the energy stored in the inductor per coil cycle and therefore the light output. The other important issue is that maximum current (saturation current) in the coil is set by the design and manufacturer of the coil. If the parameters of the application such as $V_{BATTERY}$, L , R_L or t_{ON} cause the current in the coil to increase beyond its rated I_{SAT} , excessive heat will be generated and the power efficiency will decrease with no additional light output. The **Sipex SP4422A** is final tested using a 5mH/18Ω coil from Hitachi Metals. For suggested coil sources see **page 10**.

The supply V_{DD} can range from 2.2 to 5.0V. It is not necessary that $V_{DD} = V_{BATTERY}$. $V_{BATTERY}$ should not exceed max coil current specification. The majority of the current goes through the coil and is typically much greater than I_{DD} .

The f_{COIL} signal controls a switch that connects the end of the coil at pin 3 to ground or to open circuit. The f_{COIL} signal is a 94% duty cycle signal switching at 1/8 the oscillator frequency. For a 64kHz oscillator f_{COIL} is 8kHz. During the time when the f_{COIL} signal is high, the coil is connected from $V_{BATTERY}$ to ground and a charged magnetic field is created in the coil. During the low part of f_{COIL} , the ground connection is switched open, the field collapses and the energy in the inductor is forced to flow toward the high voltage H-bridge switches. f_{COIL} will send 16 of these charge pulses (see **figure 2** on **page 9**) to the lamp, each pulse increases the voltage drop across the lamp in discrete steps. As the voltage potential approaches its maximum, the steps become smaller (see **figure 1** on **page 9**).

The H-bridge consists of two SCR structures that act as high voltage switches. These two switches control the polarity of how the lamp is charged. The SCR switches are controlled by the f_{LAMP} signal which is the oscillator frequency divided by 256. For a 64kHz oscillator, $f_{LAMP} = 256Hz$.

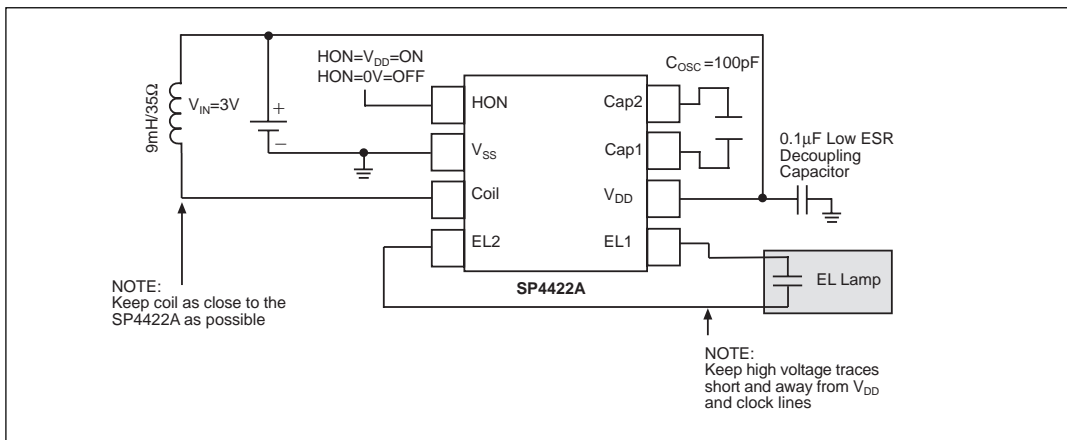

Typical SP4422A Application Circuit

When the energy from the coil is released, a high voltage spike is created triggering the SCR switches. The direction of current flow is determined by which SCR is enabled. One full cycle of the H-bridge will create 16 voltage steps from ground to 80V (typical) on pins 4 and 5 which are 180 degrees out of phase from each other (see *figure 3* on *page 9*). A differential representation of the outputs is shown in *figure 4* on *page 9*.

Layout Considerations

The **SP4422A** circuit board layout must observe careful analog precautions. For applications with noisy voltage power supplies a 0.1 μ F low ESR decoupling capacitor must be connected from V_{DD} to ground. Any high voltage traces should be isolated from any digital clock traces or enable lines. A solid ground plane connection is strongly recommended. All traces to the coil or to the high voltage outputs should be kept as short as possible to minimize capacitive coupling to digital clock lines and to reduce EMI emissions.

Electroluminescent Technology

What is electroluminescence?

An EL lamp is basically a strip of plastic that is coated with a phosphorous material which emits light (fluoresces) when a high voltage (>40V) which was first applied across it, is removed or reversed. Long periods of DC voltages applied to the material tend to breakdown the material and reduce its lifetime. With these considerations in mind, the ideal signal to drive an EL lamp is a high voltage sine wave. Traditional approaches to

achieving this type of waveform included discrete circuits incorporating a transformer, transistors, and several resistors and capacitors. This approach is large and bulky, and cannot be implemented in most hand held equipment. **Sipex** now offers low power single chip driver circuits specifically designed to drive small to medium sized electroluminescent panels. All that is required is one external inductor and capacitor.

Electroluminescent backlighting is ideal when used with LCD displays, keypads, or other backlit readouts. Its main use is to illuminate displays in dim to dark conditions for momentary periods of time. EL lamps typically consume less than LEDs or bulbs making them ideal for battery powered products. Also, EL lamps are able to evenly light an area without creating "hot spots" in the display.

The amount of light emitted is a function of the voltage applied to the lamp, the frequency at which it is applied, the lamp material used and its size, and lastly, the inductor used. There are many variables which can be optimized for specific applications. **Sipex** supplies characterization charts to aid the designer in selecting the optimum circuit configuration (see *page 6*).

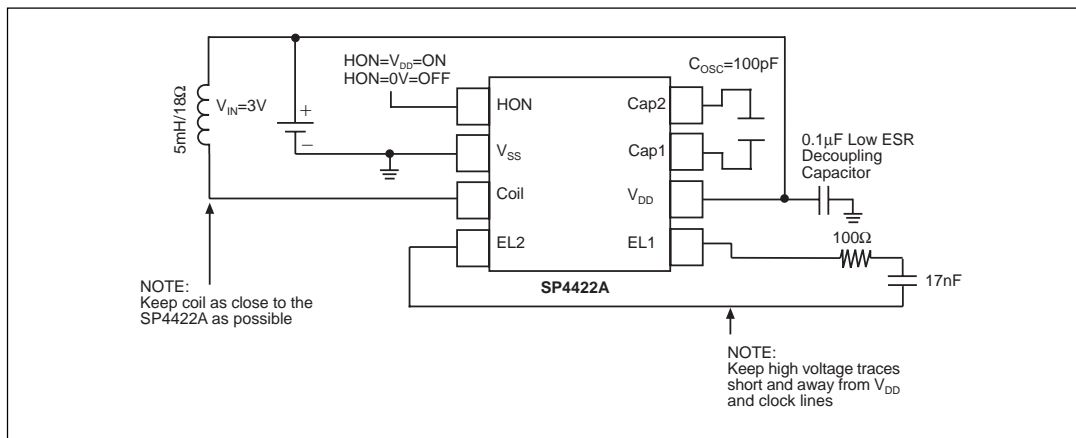

SP4422A Test Circuit

The following performance curves are intended to give the designer a relative scale from which to optimize specific applications. Absolute measurements may vary depending upon the brand of components chosen.

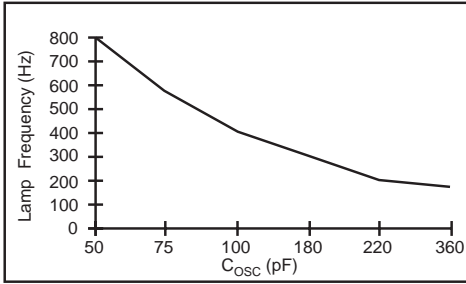

Lamp Frequency vs C_{OSC}
V_{DD} = 3.0V; Coil = 9mH, 35Ω; Lamp = 1 sq. in.

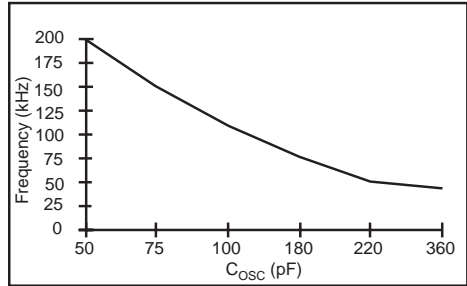

Oscillator Frequency vs C_{OSC}
V_{DD} = 3.0V; Coil = 9mH, 35Ω; Lamp = 1 sq. in.

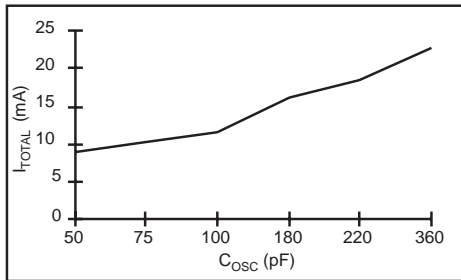

I_{TOTAL} vs C_{OSC}
V_{DD} = 3.0V; Coil = 9mH, 35Ω; Lamp = 1 sq. in.

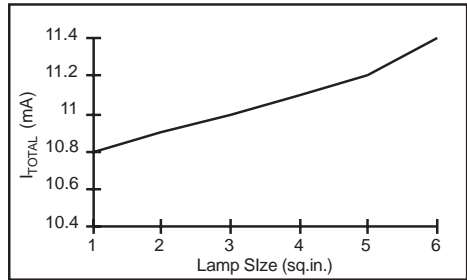

I_{TOTAL} vs Lamp Size
V_{DD} = 3.0V; Coil = 9mH, 35Ω; C_{OSC} = 180pF

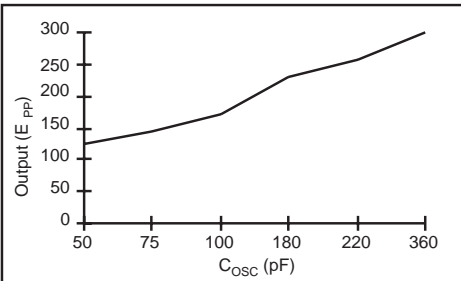

Output Voltage vs C_{OSC}
V_{DD} = 3.0V; Coil = 9mH, 35Ω; Lamp = 1 sq. in.

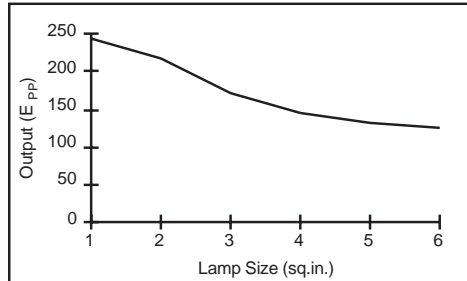

Output Voltage vs Lamp Size.
V_{DD} = 3.0V; Coil = 9mH, 35Ω; C_{OSC} = 180pF

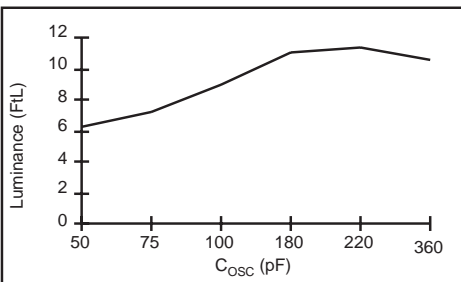

Luminance vs C_{OSC}
V_{DD} = 3.0V; Coil = 9mH, 35Ω; Lamp = 1 sq. in.

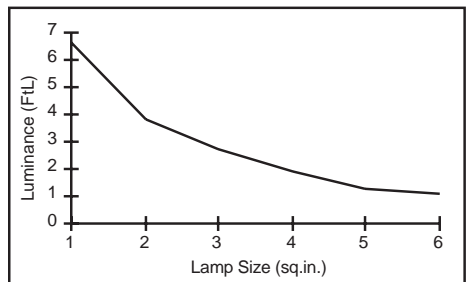

Luminance vs Lamp Size.
V_{DD} = 3.0V; Coil = 9mH, 35Ω; C_{OSC} = 180pF

The following performance curves are intended to give the designer a relative scale from which to optimize specific applications. Absolute measurements may vary depending upon the brand of components chosen.

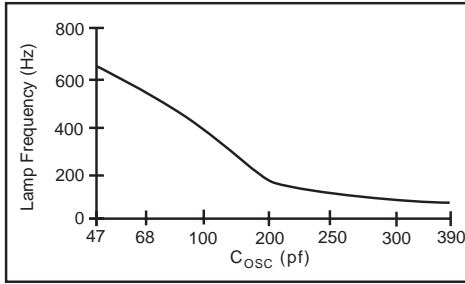

Lamp Frequency vs. C_{osc}
V_{DD} = 3.0V; Coil = 5mH, 18Ω; Load = 10nF

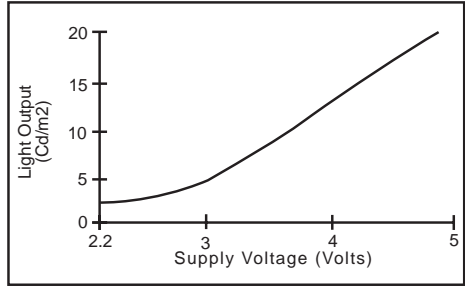

Luminance vs. V_{DD} = V_{coil}
V_{DD} = 3.0V; Coil = 5mH, 18Ω; Load = 10nF

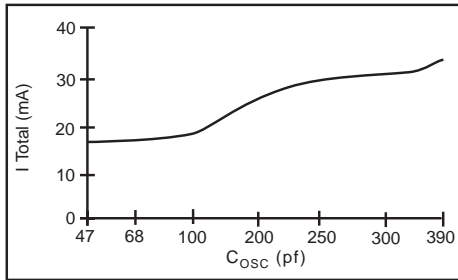

I_{TOTAL} vs. C_{osc}
V_{DD} = 3.0V; Coil = 5mH, 18Ω; Load = 10nF

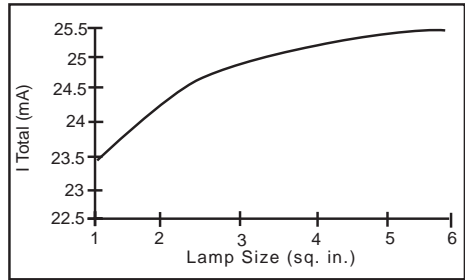

I_{TOTAL} vs. Lamp Size
V_{DD} = 3.0V; Coil = 5mH, 18Ω; C_{osc} = 100pF

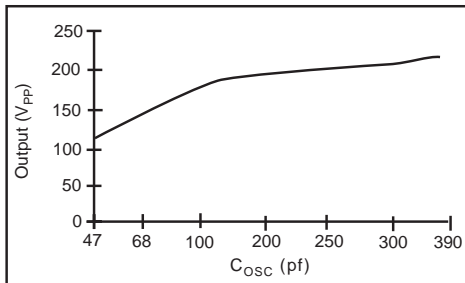

Output Voltage vs. C_{osc}
V_{DD} = 3.0V; Coil = 5mH, 18Ω; Load = 10nF

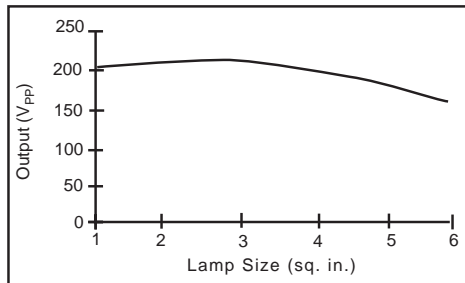

Output Voltage vs. Lamp Size.
V_{DD} = 3.0V; Coil = 5mH, 18Ω; C_{osc} = 100pF

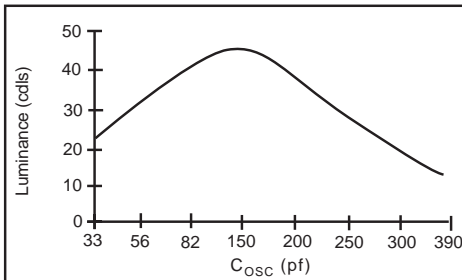

Luminance vs. C_{osc}
V_{DD} = 3.0V; Coil = 5mH, 18Ω; Load = 10nF

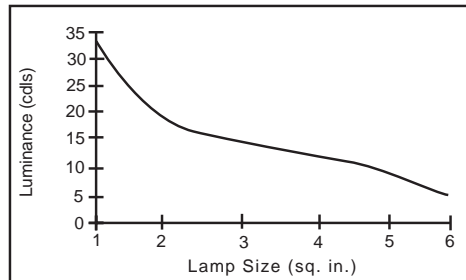

Luminance vs. Lamp Size.
V_{DD} = 3.0V; Coil = 5mH, 18Ω; C_{osc} = 100pF

The following performance curves are intended to give the designer a relative scale from which to optimize specific applications. Absolute measurements may vary depending upon the brand of components chosen.

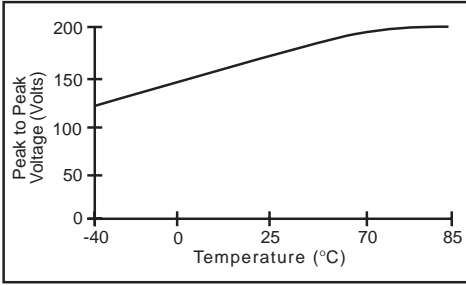

Peak to Peak Voltage vs. Temperature
 $V_{DD}=3.0V$; Coil=5mH/18Ω; $C_{OSC}=100pF$; Load=10nF

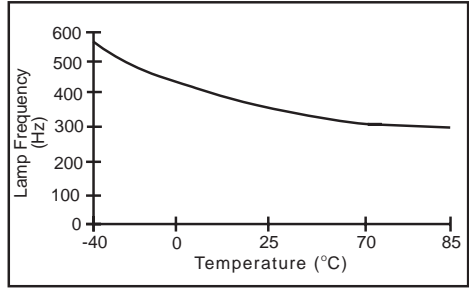

Lamp Frequency vs. Temperature
 $V_{DD}=3.0V$; Coil=5mH/18Ω; $C_{OSC}=100pF$; Load=10nF

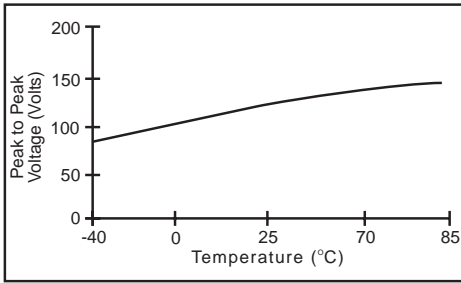

Peak to Peak Voltage vs. Temperature
 $V_{DD}=2.2V$; Coil=5mH/18Ω; $C_{OSC}=100pF$; Load=10nF

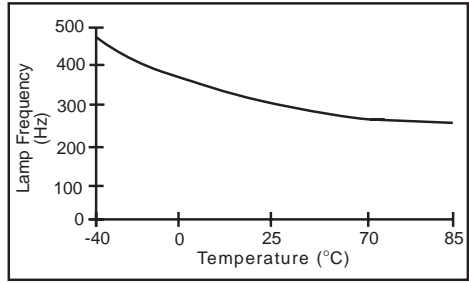

Lamp Frequency vs. Temperature
 $V_{DD}=2.2V$; Coil=5mH/18Ω; $C_{OSC}=100pF$; Load=10nF

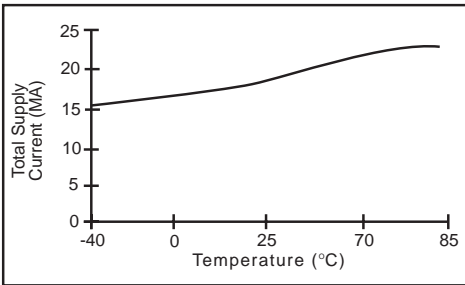

Total Supply Current vs. Temperature
 $V_{DD}=3.0V$; Coil=5mH/18Ω; $C_{OSC}=100pF$; Load=10nF

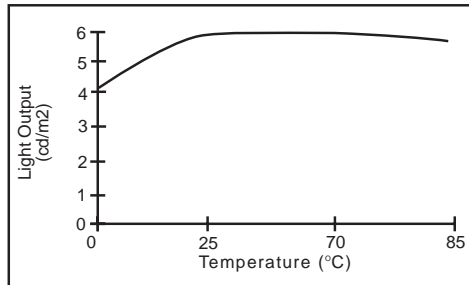

Light Output vs. Temperature
 $V_{DD}=3.0V$; Coil=5mH/18Ω; $C_{OSC}=100pF$; Lamp=6sq.in.

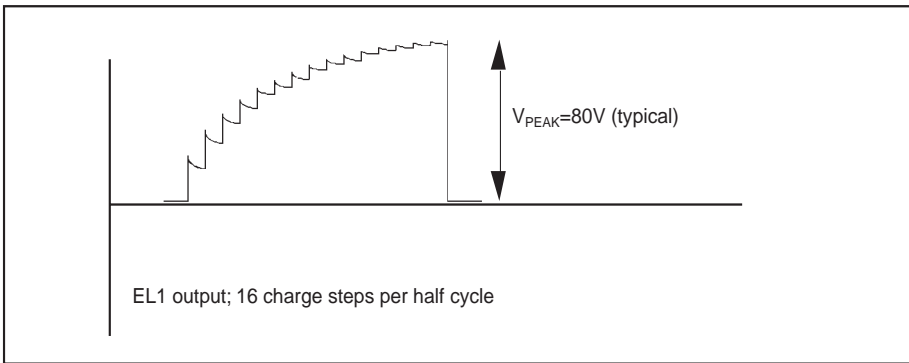

Figure 1. EL output voltage in discrete steps at EL1 output

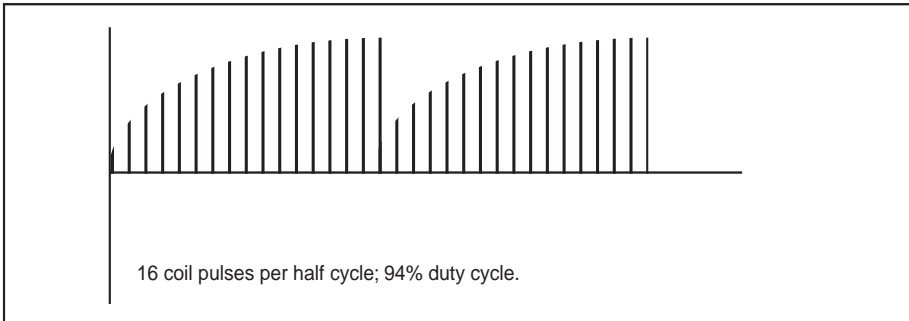

Figure 2. Voltage pulses released from the coil to the EL driver circuitry

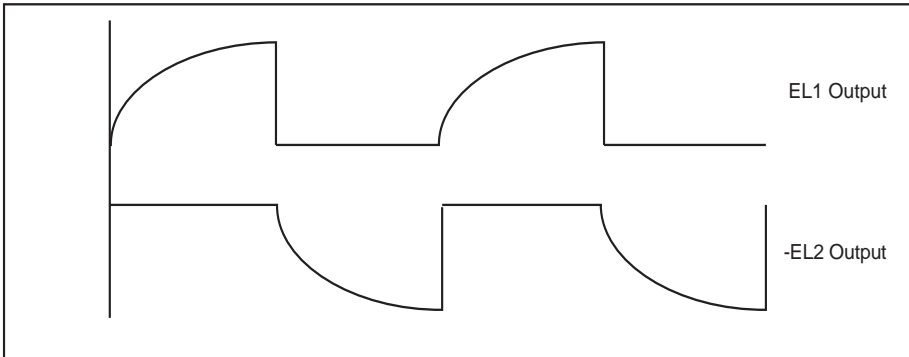

Figure 3. EL voltage waveforms from the EL1 and EL2 outputs

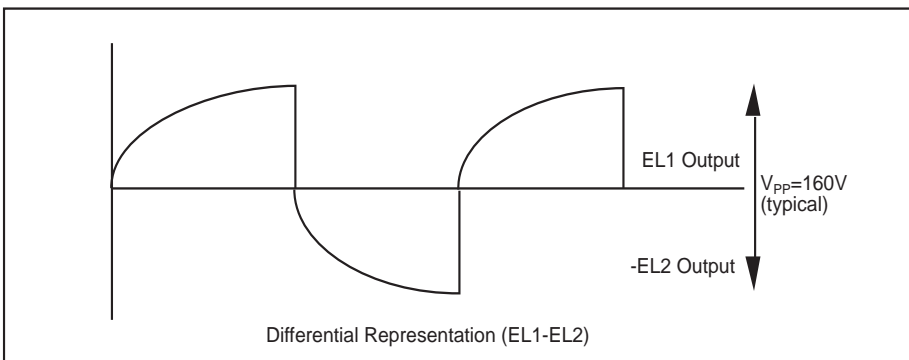
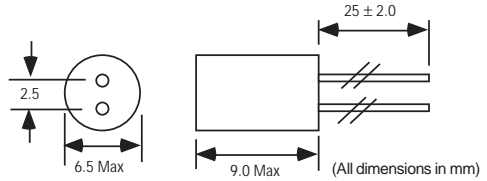

Figure 4. EL differential output waveform of the EL1 and EL2 outputs

The coil part numbers presented in this data sheet have been qualified as being suitable for the SP4422A product. Contact Sipex for applications assistance in choosing coil values not listed in this data sheet.

CTC Coils LTD Hong Kong
 Ph: 85-2695-4889
 Fax: 85-2695-1842

Mark Technologies:
 North American Stocking
 distributor for Sankyo and CTC
 Ph: 905-891-0165
 Fax: 905-891-8534



Model Numbers: CH5070AS-203K-006 (20mH, 65Ω)
 Sipex Number: S51208-M-1021-Sipex

HITACHI METALS Ltd. Japan
 Ph: 3-3284-4936
 Fax: 3-3287-1945

HITACHI METALS Hong Kong
 Ph: 852-2724-4183
 Fax: 852-2311-2093

HITACHI METALS Singapore
 Ph: 65-222-3077
 Fax: 65-222-5232

HITACHI METALS Chicago, IL
 Ph: 847-364-7200
 Fax: 847-364-7279

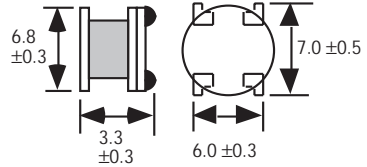

Part Numbers:
 MD735L902B (9mH + 20% 41Ω)
 MD735L502A (5mH ± 20% 19.8Ω)

Toko Inc. Japan
 Ph: 03-3727-1161
 Fax: 03-3727-1176

Toko Inc. Singapore
 Ph: 255-4000
 Fax: 250-8134

Toko Korea
 Ph: 0551-50-5500
 Fax: 0551-93-1110

Toko America Inc. USA
 Ph: 847-297-0070
 Fax: 847-699-7864

Toko Germany
 Ph: 49-7156-96-060
 Fax: 49-7156-96-06-26

Toko France
 Ph: 01-4557-4465
 Fax: 01-4554-2837

Part Numbers:
 667MA-472N (4.7mH, 13Ω)

Toko U.K.
 Ph: 1753-854057-9
 Fax: 1753-8503-23

Toko Hong Kong
 Ph: 2342-8131
 Fax: 2341-9570

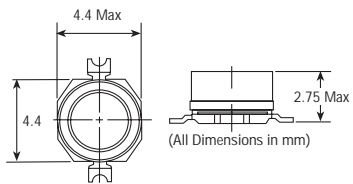

muRata USA
 Ph: 770-436-1300
 Fax: 770-436-3030

muRata Taiwan
 Ph: 88-6429-1415-1
 Fax: 88-6442-5292-9

muRata Hong Kong
 Ph: 85-2237-6389-8
 Fax: 85-2237-5556-55

muRata Europe
 Ph: 49-9116-6870
 Fax: 49-1166-8722-5

muRata Singapore
 Ph: 65-758-4233
 Fax: 65-753-6181

Part Numbers:
 LQN6C472M04 (4.7mH, 35Ω)
 LQN6C103M04 (10mH, 80Ω)

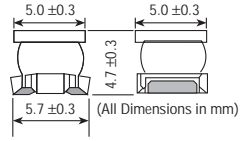

Coilcraft USA
 Ph: 847-639-6400
 Fax: 847-639-1469

Coilcraft Taiwan
 Ph: 886-2-264-3646
 Fax: 886-2-270-0294

Coilcraft Hong Kong
 Ph: 852-770-9428
 Fax: 852-770-0729

Coilcraft Europe
 Ph: 44-01236-730595
 Fax: 44-01236-730627

Coilcraft Singapore
 Ph: 65-296-6933
 Fax: 465-296-4463 #382

Part Numbers:
 DS1608C-106 (10mH, 32Ω)

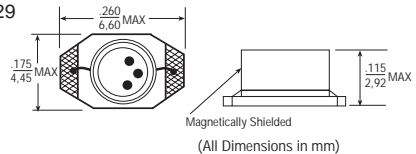

Magnetically Shielded

(All Dimensions in mm)

EL polarizers/transflector manufacturers

Nitto Denko
San Jose, CA
Phone: (510) 445-5400

Astra Products
Baldwin, NJ
Phone: (516) 223-7500
Fax: (516) 868-2371

EL Lamp manufacturers

Metro Mark/Leading Edge
Minnetonka, MN
Phone: (800) 680-5556
Phone: (612) 912-1700

Midori Mark Ltd.
1-5 Komagata 2-Chome
Taita-Ku 111-0043 Japan
Phone: 81-03-3848-2011

Luminescent Systems Inc. (LSI)
Lebanon, NH
Phone: (603) 643-7766
Fax: (603) 643-5947

NEC Corporation
Tokyo, Japan
Phone: (03) 3798-9572
Fax: (03) 3798-6134

Seiko Precision
Tokyo, Japan
Phone: (03) 5610-7089
Fax: .) 5610-7177

Gunze Electronics
2113 Wells Branch Parkway
Austin, TX 78728
Phone: (512) 752-1299
Fax: (512) 252-1181

All package dimensions in inches

8-pin NSOIC

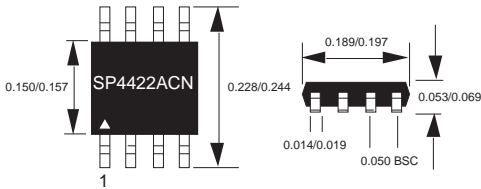

8-pin μ SOIC

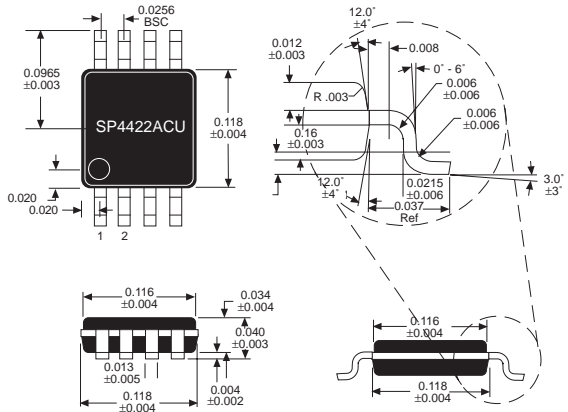

95 SP4422ACN per tube, no minimum quantity

50 SP4422ACU per tube

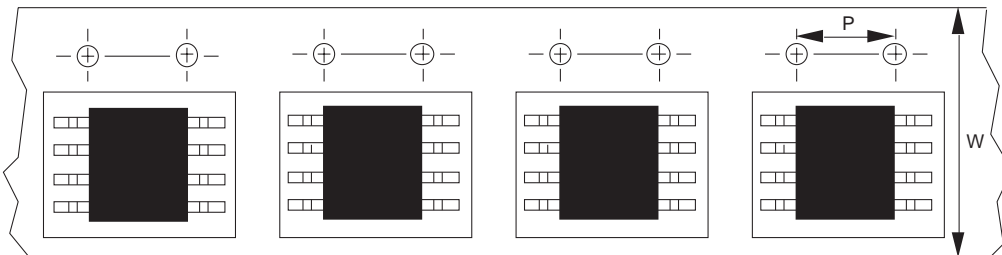

NSOIC-8 13" reels: P=8mm, W=12mm			
μ SOIC-8 13" reels: P=8mm, W=12mm			
Pkg.	Minimum qty per reel	Standard qty per reel	Maximum qty per reel
ACN	500	2500	3000
ACU	500	2500	3000

ORDERING INFORMATION

Model	Operating Temperature Range	Package Type
SP4422ACN	-40°C to +85°C	8-Pin NSOIC
SP4422ACU	-40°C to +85°C	8-Pin μ SOIC
SP4422ACX	-40°C to +85°C	Die
SP4422ANEB	N/A	Evaluation Board
SP4422AUEB	N/A	Evaluation Board

Please consult the factory for pricing and availability on a Tape-On-Reel option.



SIGNAL PROCESSING EXCELLENCE

Sipex Corporation

Headquarters and Sales Office

22 Linnell Circle
Billerica, MA 01821
TEL: (978) 667-8700
FAX: (978) 670-9001
e-mail: sales@sipex.com

Sales Office

233 South Hillview Drive
Milpitas, CA 95035
TEL: (408) 934-7500
FAX: (408) 935-7600

Sipex Corporation reserves the right to make changes to any products described herein. Sipex does not assume any liability arising out of the application or use of any product or circuit described hereing; neither does it convey any license under its patent rights nor the rights of others.