

# System Reset Monolithic IC PST91XX Series

## Outline

The function of this low reset type IC is to accurately reset systems after detecting the supply voltage at the time of switching power on and instantaneous power off in various CPU and other logic systems. Further, this IC, with its super low consumption current and high precision voltage detection capacity, is most suited as a voltage check circuit for a number of products which use batteries.

## Features

- |  |   |
|--|---|
| 1. High precision voltage detection  | $V_s \pm 3\%$ max.                                  |
| 2. Super low current consumption   | $I_{CCH} = 1.5\mu A$ typ. $I_{CCL} = 1.0\mu A$ typ. |
| 3. Low operating threshold voltage   | 0.65V typ.  |
| 4. Hysteresis voltage is provided as a detect voltage  | 50mV typ.   |
| 5. Large output current at the time ON   | 15mA typ.   |
| 6. The detect voltage can be selected at your discretion at 0.1V step within the range of 1.9 to 4.6V by the following stipulation method. |   |

PST91XX



(Example : for 4.2V ..... PST9142)

## Package

- TO-92A (PST91XX)
- SOT-25A (PST91XXN)

## Applications

1. Reset circuits for microcomputers, CPU and MPU.
2. Reset circuit for logic circuitry.
3. Battery voltage check circuit.
4. Circuit for changing over to backup battery.
5. Level detecting circuit.

## Pin Assignment

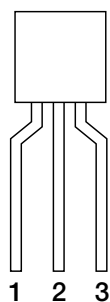

TO-92A

1	$V_{OUT}$
2	$V_{CC}$
3	GND

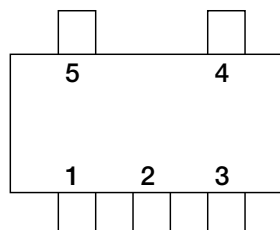

SOT-25A

1	NC
2	SUB
3	GND
4	$V_{OUT}$
5	$V_{CC}$

(Note) The pin 2 of SOT-25 package is a SUB terminal. Connect it to GND.

**Equivalent Circuit Diagram**

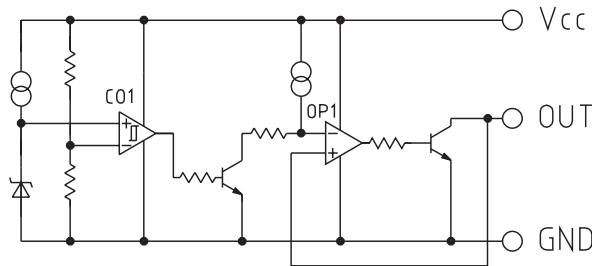

**Absolute Maximum Ratings** (Ta=25°C)

Item	Symbol	Ratings	Units
Storage temperature	T <sub>STG</sub>	-40~+125	°C
Operating temperature	T <sub>OPR</sub>	-20~+75	°C
Power supply voltage	V <sub>CC</sub>	-0.3~10	V
Allowable loss	P <sub>d</sub>	150 (SOT-25A) 300 (TO-92A)	mW

**Electrical Characteristics** (Ta=25°C) (The unit of resistance is Ω unless otherwise indicated.)

Item	Symbol	Measurement Circuit	Measurement conditions	Min.	Typ.	Max.	Units
Detection Voltage	V <sub>s</sub>	1	R <sub>L</sub> =4.7k, V <sub>OL</sub> ≤ 0.4V V <sub>CC</sub> =H→L	-3% typ.	4.6~ 1.9 (0.1V step)	+3% typ.	V
Hysteresis Voltage	ΔV <sub>s</sub>	1	R <sub>L</sub> =470, V <sub>CC</sub> =L→H→L	30	50	100	mV
Detection Voltage Temperature Coefficient	V <sub>s</sub> /ΔT	1	R <sub>L</sub> =470, Ta=-20~+75°C		±0.01		%/°C
Low Level Output Voltage	V <sub>OL</sub>	1	V <sub>CC</sub> =V <sub>s</sub> min.-0.05V, R <sub>L</sub> =470		0.2	0.4	V
Output Leakage Current	I <sub>OH</sub>	1	V <sub>CC</sub> =10V			0.1	μA
Circuit Current at ON Time	I <sub>CC</sub> L	1	V <sub>CC</sub> =V <sub>s</sub> min.-0.05V, R <sub>L</sub> =∞		1.0	2.0	μA
Circuit Current at OFF Time	I <sub>CC</sub> H	1	V <sub>CC</sub> =V <sub>s</sub> typ./0.85V, R <sub>L</sub> =∞		1.5	2.5	μA
"H" Transmission Delay Time	tpLH	2	C <sub>L</sub> =100pF, R <sub>L</sub> =4.7k		20	60	μS
"L" Transmission Delay Time	tpHL	2	C <sub>L</sub> =100pF, R <sub>L</sub> =4.7k		20	60	μS
Operating Threshold Voltage	V <sub>OP</sub> L	1	R <sub>L</sub> =4.7k, V <sub>OL</sub> ≤ 0.4V		0.65	0.85	V
Output Current at ON Time 1	I <sub>OL</sub> 1	1	R <sub>L</sub> =0, V <sub>CC</sub> =V <sub>s</sub> min.-0.05V	5			mA
Output Current at ON Time 2	I <sub>OL</sub> 2	1	Ta=-20~+75°C R <sub>L</sub> =0, V <sub>CC</sub> =V <sub>s</sub> min.-0.05V	3			mA

Application Circuits

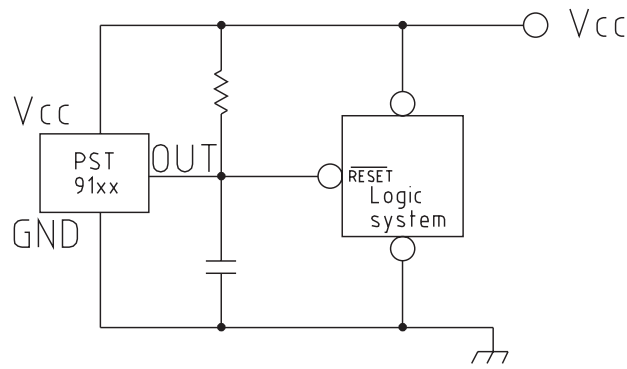

Characteristics (Example: PST9145)

■ Vs vs. Ta

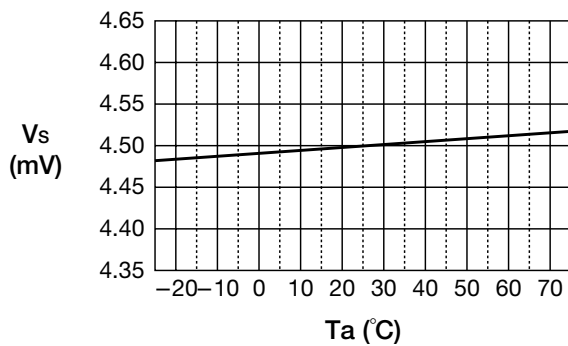

■ IoL vs. Ta

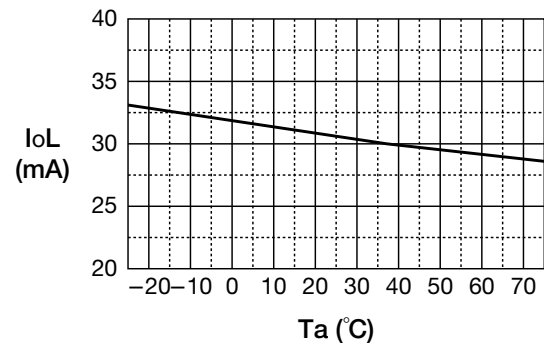

■ IccH vs. Ta

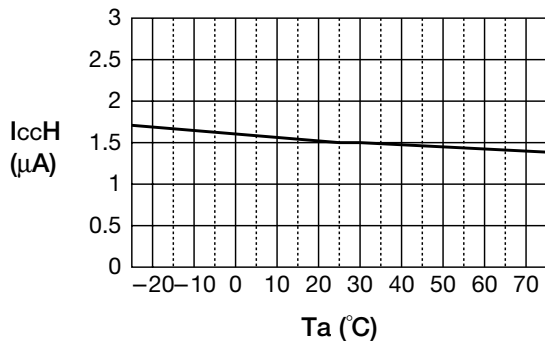

■ ΔVs vs. Ta

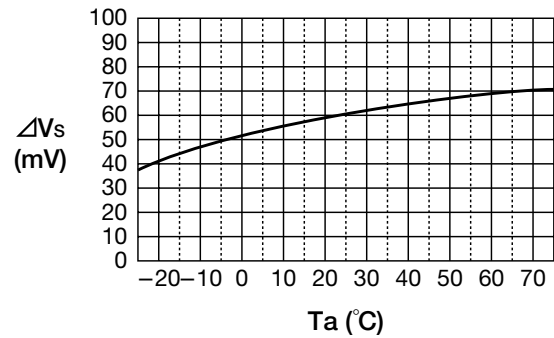

■ VopL vs. Ta

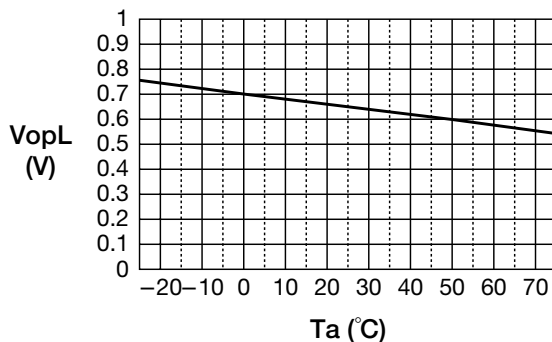

■ VoL vs. Ta

