

MAXIM

Precision Low Voltage Micropower Operational Amplifier

OP90

General Description

The OP90 is a precision bipolar micropower operational amplifier with flexible power supply capability. Both the input voltage range and output voltage swing of the OP90 include the negative rail, allowing "ground-sensing" operation when the part is driven from a single positive voltage supply. The OP90 will accept a single power supply voltage of any value in the range +1.6V to +36V. Alternatively, the amplifier can be operated from dual power supplies in the range of $\pm 0.8V$ to $\pm 18V$.

Unlike most other micropower operational amplifiers, the OP90 requires no external current setting resistor, and consumes less than $20\mu A$ of quiescent current, allowing operation from a lithium battery of greater than 10,000 hours. Even with this minimal current consumption, the amplifier can sink or source 5mA of current into the load.

Every OP90 (A/E grade) is internally trimmed to guarantee an input offset voltage of less than $150\mu V$. This eliminates the need for external nulling in most applications, although null pins are provided if required. The guaranteed minimum open loop gain of 700,000 together with power supply rejection ratio of $5.6\mu V/V$ and common-mode rejection ratio of 100dB allow the OP90 to be used in applications requiring low power operation together with precision performance.

Applications

- Precision Micropower Amplifiers
- Micropower Signal Processing
- Battery Powered Analog Circuits

Typical Operating Circuit

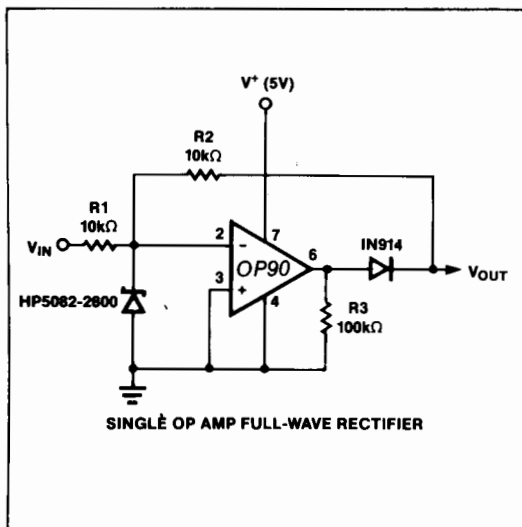

Features

- ◆ Single/Dual Supply Operation: +1.6V to +36V, $\pm 0.8V$ to $\pm 18V$
- ◆ True Single-Supply Operation: Input and Output Voltage Ranges Include Ground
- ◆ Low Supply Current: $20\mu A$ Max
- ◆ High Output Drive: 5mA Min
- ◆ Low Input Offset Voltage: $150\mu V$ Max
- ◆ High Open Loop Gain: 700V/mV Min
- ◆ High PSRR: $5.6\mu V/V$ Max
- ◆ Standard 741 Pin Out With Nulling to V^-

Ordering Information

PART	TEMP. RANGE	PACKAGE
OP90AZ	-55°C to +125°C	8 Lead CERDIP
OP90EZ	-25°C to +85°C	8 Lead CERDIP
OP90FZ	-25°C to +85°C	8 Lead CERDIP
OP90GP	0°C to +70°C	8 Lead Plastic DIP
OP90GS	0°C to +70°C	8 Lead SO
OP90GC/D	0°C to +70°C	Dice

Pin Configuration

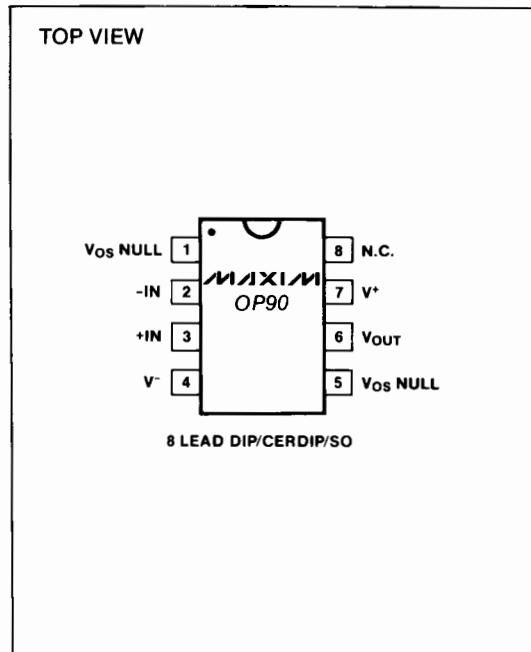

MAXIM

MAXIM is a registered trademark of Maxim Integrated Products.

Maxim Integrated Products 3-69

Precision Low Voltage Micropower Operational Amplifier

ABSOLUTE MAXIMUM RATINGS (Note 1)

Supply Voltage (V^+ to V^-) $\pm 18V$	Storage Temperature Range $-65^\circ C$ to $+150^\circ C$
Internal Power Dissipation 500mW	Operating Temperature Range	
Hermetic DIP (Z) — derate at $7.1mW/^\circ C$ above $+80^\circ C$		OP90A $-55^\circ C$ to $+125^\circ C$
Plastic DIP (P) — derate at $5.6mW/^\circ C$ above $+36^\circ C$		OP90E, OP90F $-25^\circ C$ to $+85^\circ C$
Small Outline (S) — derate at $5mW/^\circ C$ above $+55^\circ C$		OP90G $0^\circ C$ to $+70^\circ C$
Differential Input Voltage $[(V^-)-20V]$ to $[(V^+)+20V]$	Junction Temperature (T_J) $-65^\circ C$ to $+160^\circ C$
Common Mode Input Voltage $[(V^-)-20V]$ to $[(V^+)+20V]$	Lead Temperature (Soldering, 10 sec) $+300^\circ C$
Output Short Circuit Duration Indefinite		

Note 1: Absolute maximum ratings apply to both packaged parts and Dice, unless otherwise noted.

Stresses above those listed under "Absolute Maximum Ratings" may cause permanent damage to the device. These are stress ratings only, and functional operation of the device at these or any other conditions above those indicated in the operational sections of the specifications is not implied. Exposure to absolute maximum rating conditions for extended periods may affect device reliability.

ELECTRICAL CHARACTERISTICS

($V_S = \pm 1.5V$ to $\pm 15V$, $T_A = +25^\circ C$, unless otherwise noted.)

PARAMETER	SYMBOL	CONDITIONS	OP90A/E			OP90F			OP90G			UNITS
			MIN	TYP	MAX	MIN	TYP	MAX	MIN	TYP	MAX	
Input Offset Voltage	V_{OS}			50	150		75	250		125	450	μV
Input Offset Current	I_{OS}	$V_{CM} = 0V$		0.4	3		0.4	5		0.4	5	nA
Input Bias Current	I_B	$V_{CM} = 0V$		4.0	15		4.0	20		4.0	25	nA
Large Signal Voltage Gain	A_{VO}	$V_S = \pm 15V$, $V_O = \pm 10V$ $R_L = 100k\Omega$ $R_L = 10k\Omega$ $R_L = 2k\Omega$	700	1200		500	1000		400	800		V/mV
		$V^+ = 5V$, $V^- = 0V$, $1V < V_O < 4V$ $R_L = 100k\Omega$ $R_L = 10k\Omega$	200	400		125	300		100	250		
Input Voltage Range	IVR	$V^+ = 5V$, $V^- = 0V$ $V_S = \pm 15V$ (Note 2)	0/4			0/4			0/4			V
Output Voltage Swing	V_O	$V_S = \pm 15V$ $R_L = 10k\Omega$ $R_L = 2k\Omega$	± 14	± 14.2		± 14	± 14.2		± 14	± 14.2		V
	V_{OH}	$V^+ = 5V$, $V^- = 0V$ $R_L = 2k\Omega$	4.0	4.2		4.0	4.2		4.0	4.2		V
	V_{OL}	$V^+ = 5V$, $V^- = 0V$ $R_L = 10k\Omega$		100	500		100	500		100	500	μV
Common Mode Rejection Ratio	CMRR	$V^+ = 5V$, $V^- = 0V$, $0V < V_{CM} < 4V$ $V_S = \pm 15V$, $-15V < V_{CM} < 13.5V$	90	110		80	100		80	100		dB
			100	130		90	120		90	120		
Power Supply Rejection Ratio	PSRR			1.0	5.6		1.0	5.6		3.2	10	$\mu V/V$
Slew Rate	SR	$V_S = \pm 15V$	5	12		5	12		5	12		V/ms
Supply Current	I_{SY}	$V_S = \pm 1.5V$		9	15		9	15		9	15	μA
		$V_S = \pm 15V$		14	20		14	20		14	20	
Capacitive Load Stability		$A_V = +1$ No Oscillations (Note 3)	250	650		250	650		250	650		pF

Precision Low Voltage Micropower Operational Amplifier

OP90

ELECTRICAL CHARACTERISTICS (continued)

($V_S = \pm 1.5V$ to $\pm 15V$, $T_A = +25^\circ C$, unless otherwise noted.)

PARAMETER	SYMBOL	CONDITIONS	OP90A/E			OP90F			OP90G			UNITS
			MIN	TYP	MAX	MIN	TYP	MAX	MIN	TYP	MAX	
Input Noise Voltage	$e_{n\text{-p-p}}$	$f_O = 0.1\text{Hz to } 10\text{Hz}$ $V_S = \pm 15V$	3			3			3			$\mu V_{\text{p-p}}$
Input Resistance Differential Mode	R_{IN}	$V_S = \pm 15V$	30			30			30			$M\Omega$
Input Resistance Common Mode	R_{INCM}	$V_S = \pm 15V$	20			20			20			$G\Omega$

Note 2: Guaranteed by CMRR test.

Note 3: Guaranteed by design.

ELECTRICAL CHARACTERISTICS

($V_S = \pm 1.5V$ to $\pm 15V$, $-55^\circ C \leq T_A \leq 125^\circ C$, unless otherwise noted.)

PARAMETER	SYMBOL	CONDITIONS	OP90A			UNITS
			MIN	TYP	MAX	
Input Offset Voltage	V_{OS}			80	400	μV
Average Input Offset Voltage Drift	TCV_{OS}			0.3	2.5	$\mu V/^\circ C$
Input Offset Current	I_{OS}	$V_{\text{CM}} = 0V$		1.5	5	nA
Input Bias Current	I_{B}	$V_{\text{CM}} = 0V$		4.0	20	nA
Large Signal Voltage Gain	A_{VO}	$V_S = \pm 15V$, $V_O = \pm 10V$ $R_L = 100k\Omega$ $R_L = 10k\Omega$ $R_L = 2k\Omega$	225 125 50	400 240 110		V/mV
		$V^+ = 5V$, $V^- = 0V$, $1V < V_O < 4V$ $R_L = 100k\Omega$ $R_L = 10k\Omega$	100 50	200 110		
Input Voltage Range	IVR	$V^+ = 5V$, $V^- = 0V$ $V_S = \pm 15V$ (Note 4)	0/3.5 -15/13.5			V
Output Voltage Swing	V_O	$V_S = \pm 15V$ $R_L = 10k\Omega$ $R_L = 2k\Omega$	± 13.5 ± 10.5	± 13.7 ± 11.5		V
	V_{OH}	$V^+ = 5V$, $V^- = 0V$ $R_L = 2k\Omega$	3.9	4.1		V
	V_{OL}	$V^+ = 5V$, $V^- = 0V$ $R_L = 10k\Omega$		100	500	μV
Common Mode Rejection Ratio	CMRR	$V^+ = 5V$, $V^- = 0V$, $0V < V_{\text{CM}} < 3.5V$ $V_S = \pm 15V$, $-15V < V_{\text{CM}} < 13.5V$	85 95	105 115		dB
Power Supply Rejection Ratio	PSRR			3.2	10	$\mu V/V$
Supply Current	I_{SY}	$V_S = \pm 1.5V$ $V_S = \pm 15V$		15 19	25 30	μA

Note 4: Guaranteed by CMRR test.

Precision Low Voltage Micropower Operational Amplifier

ELECTRICAL CHARACTERISTICS

($V_S = \pm 1.5V$ to $\pm 15V$, $-25^\circ C \leq T_A \leq 85^\circ C$ for OP90E/F, $0^\circ C \leq T_A \leq 70^\circ C$ for OP90G, unless otherwise noted.)

PARAMETER	SYMBOL	CONDITIONS	OP90E			OP90F			OP90G			UNITS
			MIN	TYP	MAX	MIN	TYP	MAX	MIN	TYP	MAX	
Input Offset Voltage	V_{OS}		70	270		110	550		180	675	μV	
Average Input Offset Voltage Drift	TCV_{OS}		0.3	2		0.6	5		1.2	5	$\mu V/^\circ C$	
Input Offset Current	I_{OS}	$V_{CM} = 0V$	0.8	3		1.0	5		1.3	7	nA	
Input Bias Current	I_B	$V_{CM} = 0V$	4.0	15		4.0	20		4.0	25	nA	
Large Signal Voltage Gain	A_{VO}	$V_S = \pm 15V$, $V_O = \pm 10V$ $R_L = 100k\Omega$ $R_L = 10k\Omega$ $R_L = 2k\Omega$	500 250 100	800 400 200		350 175 75	700 350 150		300 150 75	600 250 125		V/mV
		$V^+ = 5V$, $V^- = 0V$, $1V < V_O < 4V$ $R_L = 100k\Omega$ $R_L = 10k\Omega$	150 75	280 140		100 50	220 110		80 40	160 90		
Input Voltage Range	IVR	$V^+ = 5V$, $V^- = 0V$ $V_S = \pm 15V$ (Note 5)	0/3.5 -15/13.5			0/3.5 -15/13.5			0/3.5 -15/13.5		V	
Output Voltage Swing	V_O	$V_S = \pm 15V$ $R_L = 10k\Omega$ $R_L = 2k\Omega$	± 13.5 ± 10.5	± 14 ± 11.8		± 13.5 ± 10.5	± 14 ± 11.8		± 13.5 ± 10.5	± 14 ± 11.8	V	
	V_{OH}	$V^+ = 5V$, $V^- = 0V$ $R_L = 2k\Omega$	3.9	4.1		3.9	4.1		3.9	4.1	V	
	V_{OL}	$V^+ = 5V$, $V^- = 0V$ $R_L = 10k\Omega$		100	500		100	500		100	500	μV
Common Mode Rejection Ratio	CMRR	$V^+ = 5V$, $V^- = 0V$, $0V < V_{CM} < 3.5V$ $V_S = \pm 15V$, $-15V < V_{CM} < 13.5V$	90 100	110 120		80 90	100 110		80 90	100 110	dB	
Power Supply Rejection Ratio	PSRR		1.0	5.6		3.2	10		5.6	17.8	$\mu V/V$	
Supply Current	I_{SY}	$V_S = \pm 1.5V$	13	25		13	25		12	25	μA	
		$V_S = \pm 15V$	17	30		17	30		16	30		

Note 5: Guaranteed by CMRR test.

Precision Low Voltage Micropower Operational Amplifier

OP90

WAFER TEST LIMITS

($V_S = \pm 1.5V$ to $\pm 15V$, $T_A = 25^\circ C$, unless otherwise noted.)

PARAMETER	SYMBOL	CONDITIONS	OP90GBC			UNITS
			MIN	TYP	MAX	
Input Offset Voltage	V_{OS}				250	μV
Input Offset Current	I_{OS}	$V_{CM} = 0V$			5	nA
Input Bias Current	I_B	$V_{CM} = 0V$			20	nA
Large Signal Voltage Gain	A_{VO}	$V_S = \pm 15V$, $V_O = \pm 10V$ $R_L = 100k\Omega$ $R_L = 10k\Omega$	500		250	V/mV
		$V^+ = 5V$, $V^- = 0V$, $1V < V_O < 4V$ $R_L = 100k\Omega$			125	
Input Voltage Range	IVR	$V^+ = 5V$, $V^- = 0V$ $V_S = \pm 15V$ (Note 6)	0/4		-15/13.5	V
Output Voltage Swing	V_O	$V_S = \pm 15V$ $R_L = 10k\Omega$ $R_L = 2k\Omega$		± 14	± 11	V
	V_{OH}	$V^+ = 5V$, $V^- = 0V$ $R_L = 2k\Omega$		4.0		V
	V_{OL}	$V^+ = 5V$, $V^- = 0V$ $R_L = 10k\Omega$			500	μV
Common Mode Rejection Ratio	CMRR	$V^+ = 5V$, $V^- = 0V$, $0V < V_{CM} < 4V$ $V_S = \pm 15V$, $-15V < V_{CM} < 13.5V$	80		90	dB
Power Supply Rejection Ratio	PSRR				10	$\mu V/V$
Supply Current	I_{SY}	$V_S = \pm 15V$			20	μA

Note 6: Guaranteed by CMRR test.

Electrical tests are performed at wafer probe to the limits shown. Due to variations in assembly methods and normal yield loss, yield after packaging is guaranteed for standard product dice. Consult factory to negotiate specifications based on dice lot qualification through sample lot assembly and testing.

Precision Low Voltage Micropower Operational Amplifier

Typical Operating Characteristics

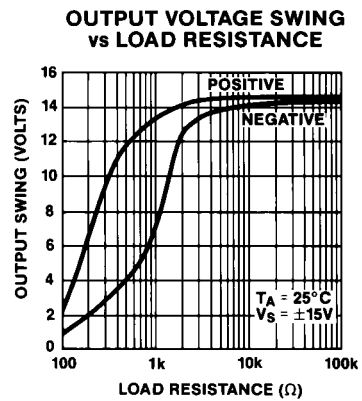
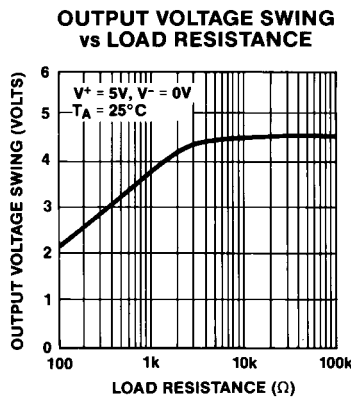
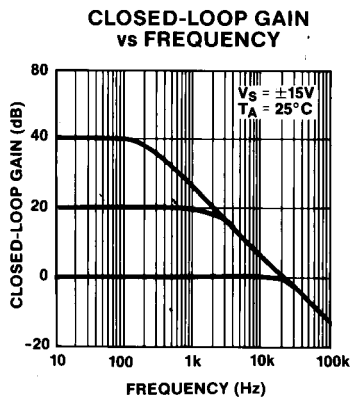
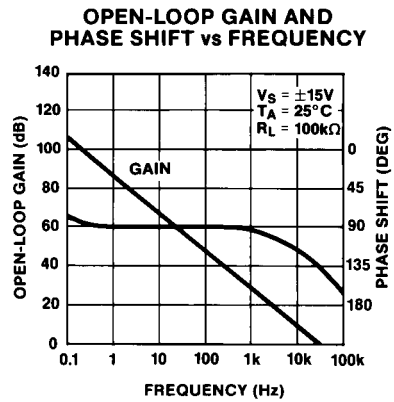
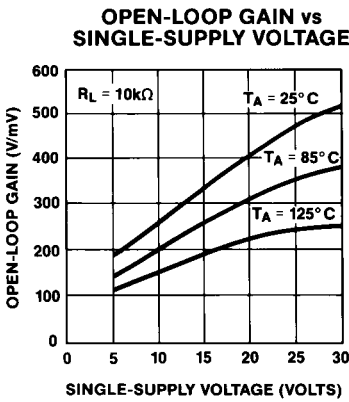
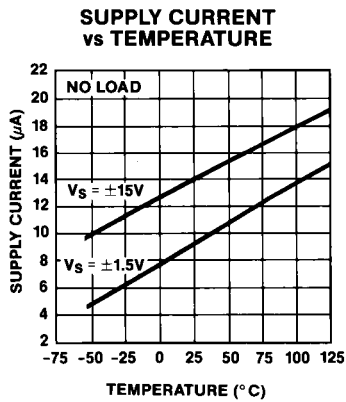
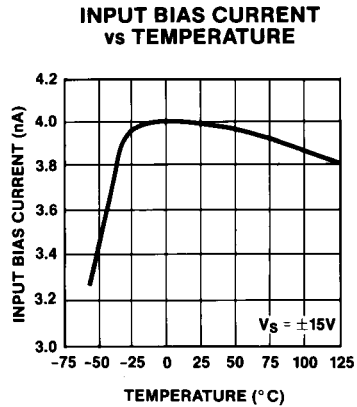
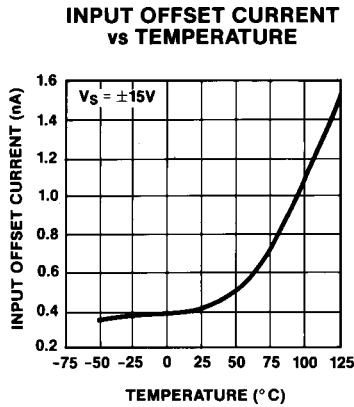
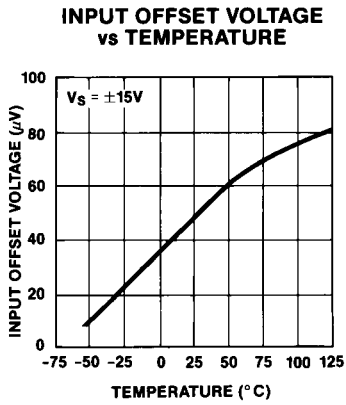

Precision Low Voltage Micropower Operational Amplifier

Typical Operating Characteristics (continued)

OP90

POWER SUPPLY REJECTION RATIO vs FREQUENCY

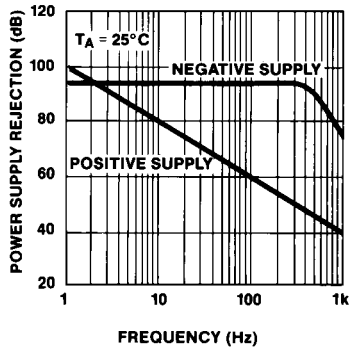

COMMON-MODE REJECTION RATIO vs FREQUENCY

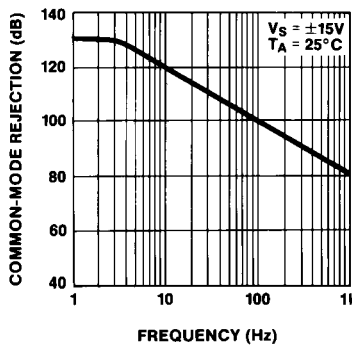

NOISE VOLTAGE DENSITY vs FREQUENCY

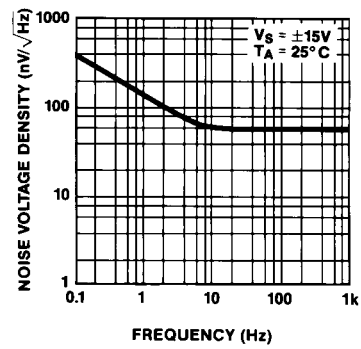

CURRENT NOISE DENSITY vs FREQUENCY

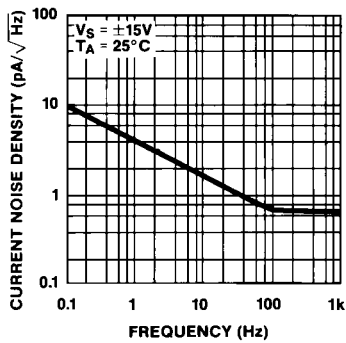

SMALL-SIGNAL TRANSIENT RESPONSE

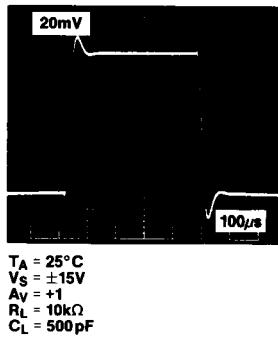

LARGE-SIGNAL TRANSIENT RESPONSE

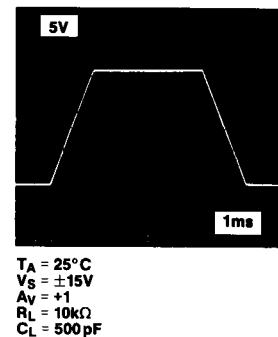

OP90

Precision Low Voltage Micropower Operational Amplifier

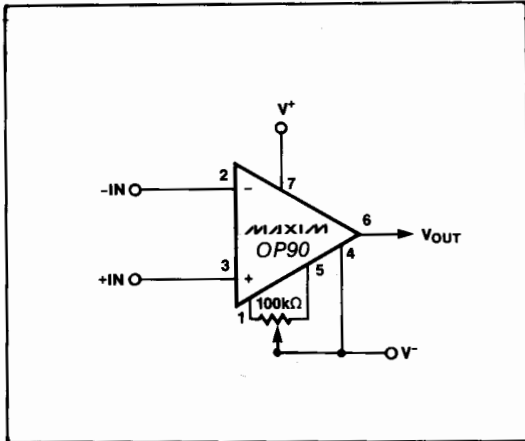

Figure 1. Offset Nulling Circuit

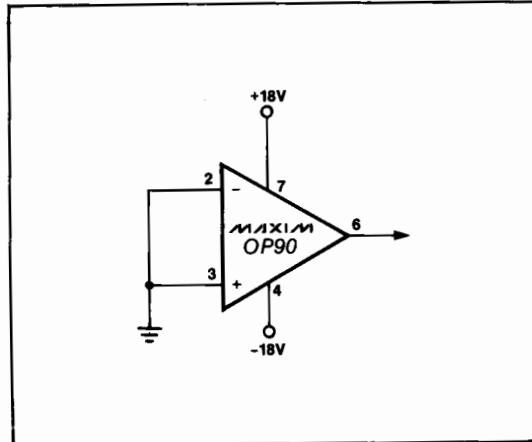
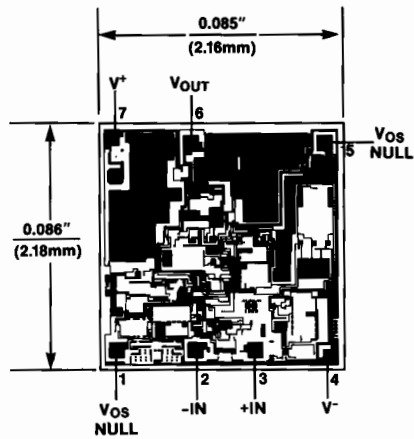

Figure 2. Burn-In Circuit

Chip Topography



Maxim cannot assume responsibility for use of any circuitry other than circuitry entirely embodied in a Maxim product. No circuit patent licenses are implied. Maxim reserves the right to change the circuitry and specifications without notice at any time.

8 Maxim Integrated Products, 120 San Gabriel Drive, Sunnyvale, CA 94086 (408) 737-7600