

2-INPUT SINGLE VIDEO SWITCH

■ GENERAL DESCRIPTION

The NJM2233B is 2-input signal video switch selecting one of two video or audio signals. Its operating voltage is 4.75 to 13V and bandwidth is 10MHz. Crosstalk is 70dB (at 4.43MHz). It is applied to both NTSC and PAL VTR.

■ FEATURES

- Operating Voltage (+4.75V~+13V)
- 2 Input-1 Output
- Crosstalk 70dB (at 4.43MHz)
- Package Outline DIP8, DMP8, SIP8, SSOP8
- Bipolar Technology

■ APPLICATION

- VCR Video Camera AV-TV Video Disc Player Audio

■ BLOCK DIAGRAM

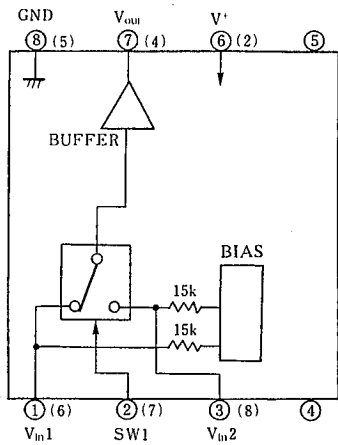

○ DIP-8, DMP-8 (4, 5pin NC)  
 ( ) SIP-8 (1, 3pin NC)

■ PACKAGE OUTLINE

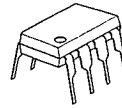

NJM2233BD



NJM2233BM



NJM2233BV

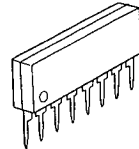

NJM2233BL

■ PIN CONFIGURATION

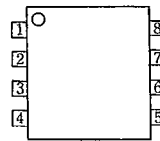

NJM2233BD  
 NJM2233BM  
 NJM2233BV

PIN FUNCTION

1.  $V_{in1}$
2. SW1
3.  $V_{in2}$
4. N.C.
5. N.C.
6.  $V^+$
7.  $V_{out}$
8. GND

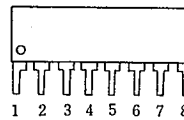

NJM2233BL

PIN FUNCTION

1. N.C.
2.  $V^+$
3. N.C.
4.  $V_{out}$
5. GND
6.  $V_{in1}$
7. SW1
8.  $V_{in2}$

5

## ■ ABSOLUTE MAXIMUM RATINGS

(Ta=25°C)

PARAMETER	SYMBOL	RATINGS	UNIT
Supply Voltage	V*	15	V
Power Dissipation	Pd	(DIP8) 500	mW
		(DMP8) 300	mW
		(SIP8) 800	mW
		(SSOP8) 250	mW
Operating Temperature Range	Topr	-20~+75	°C
Storage Temperature Range	Tstg	-40~+125	°C

## ■ ELECTRICAL CHARACTERISTICS

(V\*=5V, Ta=25°C)

PARAMETER	SYMBOL	TEST CONDITION	MIN.	TYP.	MAX.	UNIT
Operating Voltage	V*		4.75	—	13.0	V
Operating Current	ICC	S1=S2=S3=1	—	8.5	11.0	mA
Frequency Characteristic (1)	Gf1	Vi=2.5Vpp Vo(20Hz)/Vo (100kHz)	—	0	±1.0	dB
Frequency Characteristic (2)	Gf2	Vi=2.0Vpp Vo(10MHz)/Vo(100kHz)	—	0	±1.0	dB
Voltage Gain	Gv	Vi=2.5Vpp, 100kHz, Vo/Vi	-0.5	0	—	dB
Total Harmonic Distortion	THD	Vi=2.5Vpp, 1kHz	—	0.01	—	%
Differential Gain	DG	Vi=2Vpp standard staircase signal	—	0	—	%
Differential Phase	DP	Vi=2Vpp standard staircase signal	—	0	—	deg
Output Offset Voltage	Voff	S1=S2=1, S3=1→2, Vo voltage change	—	0	±15	mV
Crosstalk	CT	(S1=S3=1, S2=2) and (S1=S3=2, S2=1) Vi=2.0Vpp, 4.43MHz, Vo/Vi	—	-70	—	dB
Switch Change Voltage	VCH	Garanteed voltage of all switch on	2.4	—	—	V
	VCL	Garanteed voltage of all switch off	—	—	0.8	V
Input Impedance	Ri		—	15	—	kΩ
Output impedance	RO		—	10	—	Ω

## ■ CONTROL SIGNAL - OUTPUT SIGNAL

SW 1	OUTPUT SIGNAL
L	Vix 1
H	Vix 2

## ■ TEST CIRCUIT

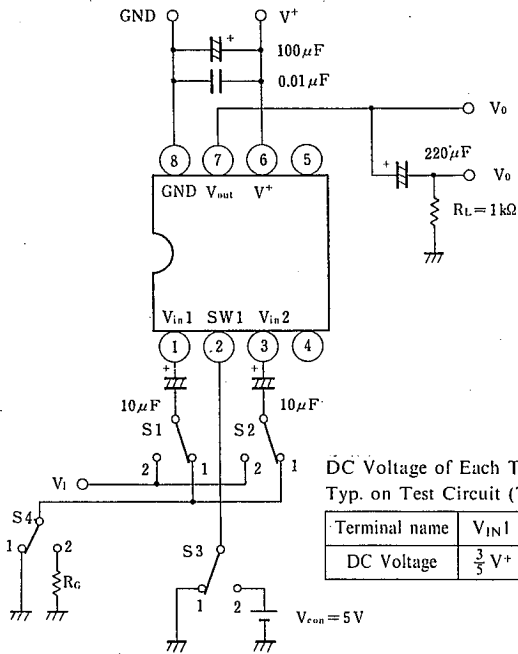

5

## ■ APPLICATION

Oscillation Prevention on light loading conditions  
Recommended under circuit

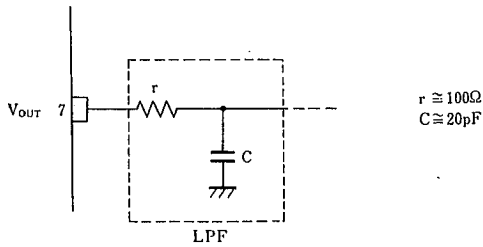

■ TYPICAL CHARACTERISTICS

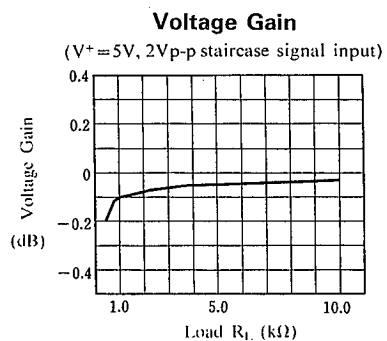
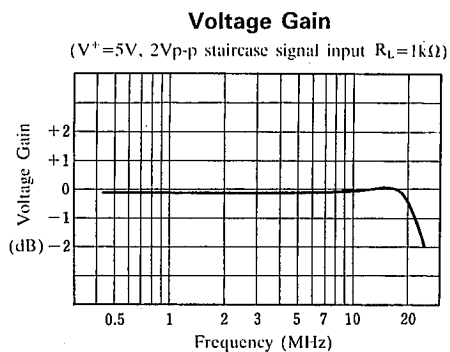
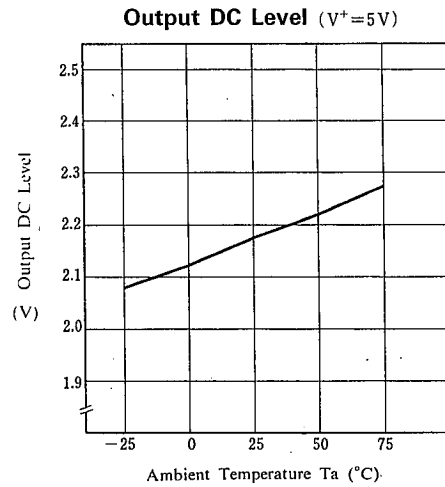
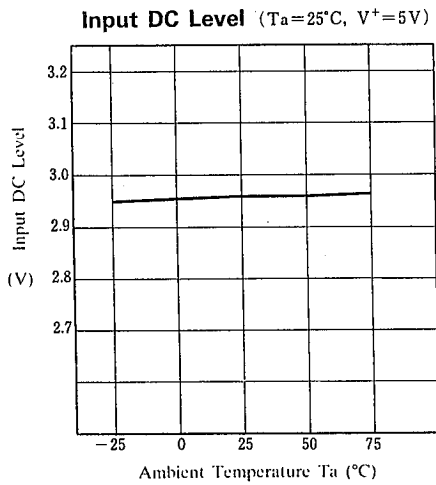
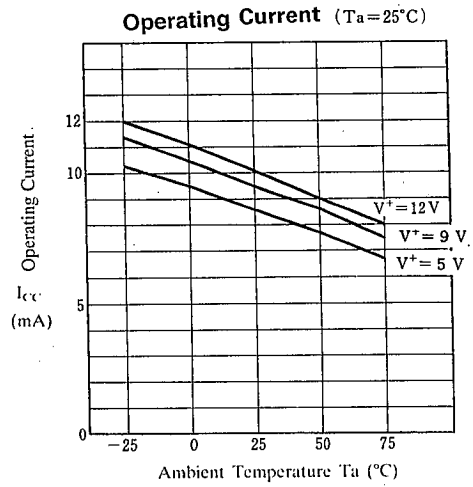
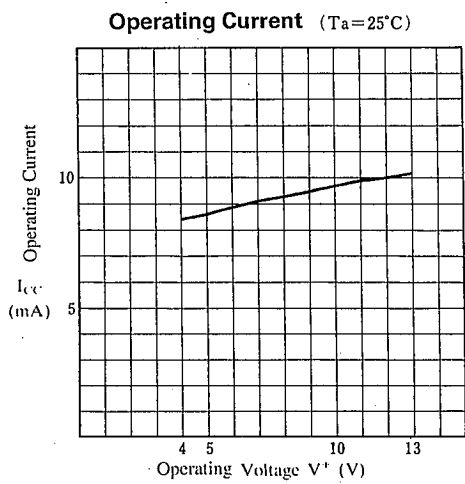

## TYPICAL CHARACTERISTICS

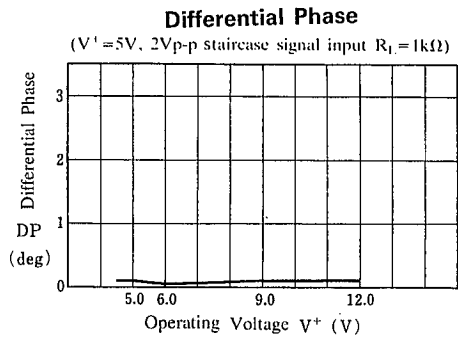
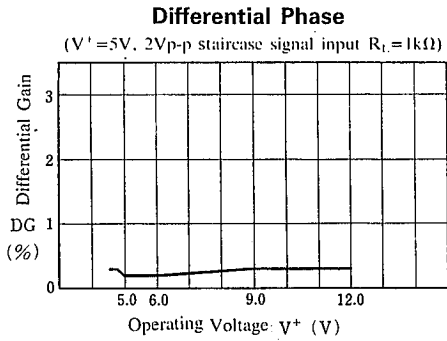
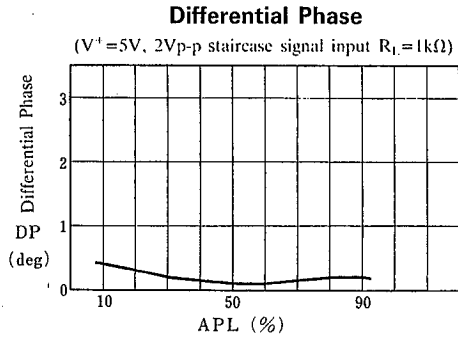
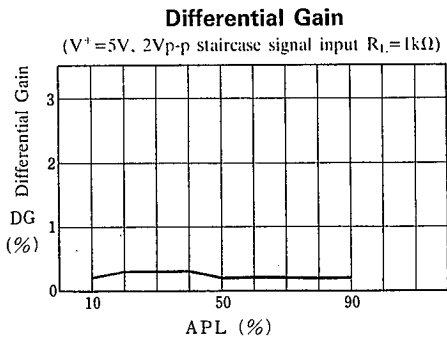
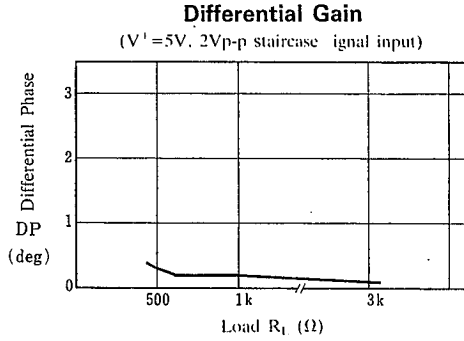
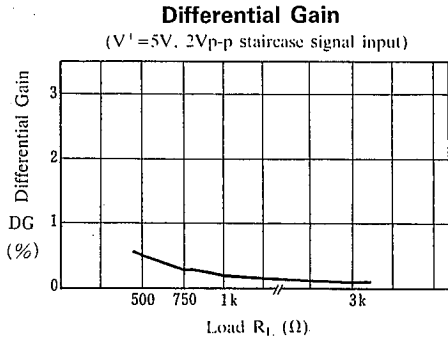

5

■ TYPICAL CHARACTERISTICS

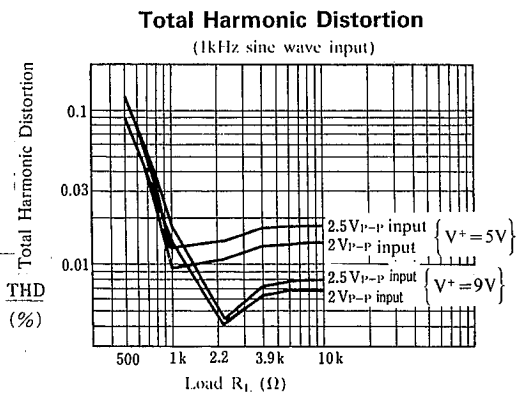
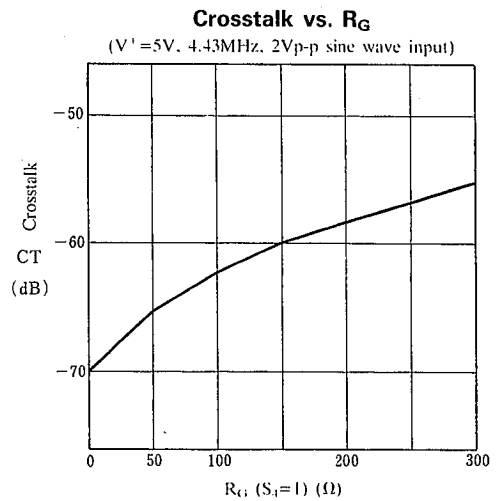
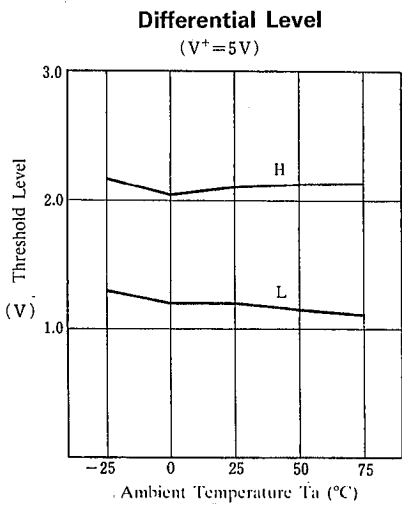
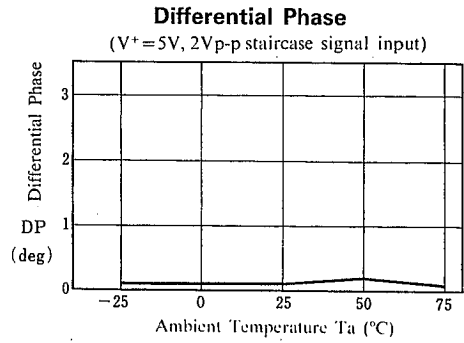
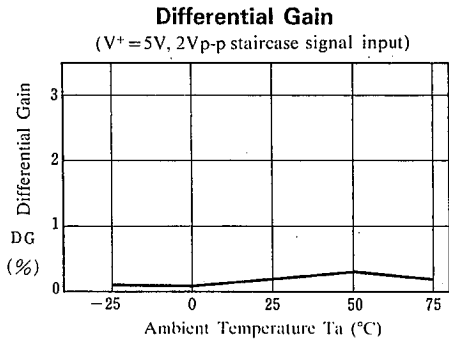

## ■ EQUIVALENT CIRCUIT

PIN NO.	SYMBOL	INSIDE EQUIVALENT CIRCUIT	PIN NO.	SYMBOL	INSIDE EQUIVALENT CIRCUIT
1	$V_{IN1}$		5	NC	_____
2	SW 1		6	$V^+$	_____
3	$V_{IN2}$		7	$V_{OUT}$	
4	NC	_____	8	GND	_____

5

## MEMO

[CAUTION]

The specifications on this databook are only given for information, without any guarantee as regards either mistakes or omissions. The application circuits in this databook are described only to show representative usages of the product and not intended for the guarantee or permission of any right including the industrial rights.