

AUDIO FILTER AMPLIFIER

■ GENERAL DESCRIPTION

The NJM2133 is a dual audio filter amplifier for digital audio. It includes two-channel voltage follower, capacitors, and resistors for Low Pass Filter. It also includes standby function which applies to low consumption power design.

It is suitable for CD, CD-ROM, DVD, and any other digital audio equipments.

■ PACKAGE OUTLINE

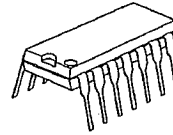

NJM2133D

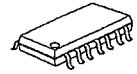

NJM2133M



NJM2133V

■ FEATURES

- Single Supply
- Operating Voltage (V⁺=4.5~5.5V)
- Internal voltage follower (Two channels)
- Internal C and R for LPF
- Standby Function
- Mute Function
- High S/N Ratio (86dB typ.)
- Bipolar Technology
- Package Outline DIP14, DMP14, SSOP14

■ PIN CONFIGURATION

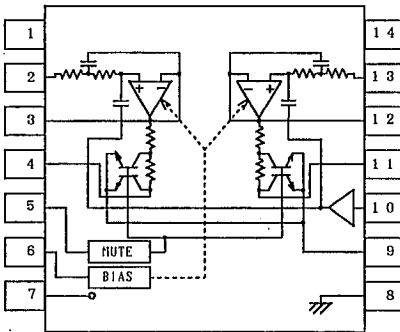

NJM2133D
NJM2133M
NJM2133V

PIN FUNCTION

- 1: NC
- 2: IN1
- 3: OUT1
- 4: MUTE1
- 5: MUTE
- 6: STANDBY
- 7: V⁺
- 8: GND
- 9: REF2
- 10: REF1
- 11: MUTE 2
- 12: OUT2
- 13: IN2
- 14: NC

■ ABSOLUTE MAXIMUM RATINGS

(Ta=25°C)

PARAMETER	SYMBOL	RATINGS	UNIT
Supply Voltage	V ⁺	12	V
Power Dissipation	P _D	(DIP8) 700 (DMP8) 300 (SSOP8) 300	mW
Operating Temperature Range	T _{OPR}	-25~+75	°C
Storage Temperature Range	T _{STG}	-40~+125	°C

■ ELECTRICAL CHARACTERISTICS

($V^+=5V$, $f=1kHz$, $V_i=1.0V_{rms}$, $V_{ref1}=2.5V$, $V_{ref2}=2.5V$, $R_L=10k\Omega$, $T_a=25^\circ C$)

PARAMETER	SYMBOL	TEST CONDITION	MIN.	TYP.	MAX.	UNIT
Operating Current	I _{oc1}		—	4.0	6.0	mA
Standby Operating Current	I _{oc2}	6pin=GND	—	1	—	mA
Voltage Gain1	G _{v1}		-1.0	0	1.0	dB
Voltage gain2	Δ G _{v2}	f=20kHz, Difference from G _{v1}	-0.5	0	0.5	dB
Voltage Gain3	G _{v3}	f=80kHz	—	-3	—	dB
Channel Balance	Δ G _{v1}	at G _{v1}	-0.5	0	0.5	dB
Total Harmonic Distortion	THD	V _o =0.2V _{rms}	—	0.015	0.05	%
S/N Ratio	S/N	BW=20~20kHz, R _g =0 Ω V _i =1.0V _{rms} reference	80	86	—	dB
Channel Separation	CS	Measuring CH: no signal, BW=20~20kHz Other CH: V _i =1.0V _{rms}	74	80	—	dB
Mute Attenuation	ATT	V _i =1.0V _{rms} , 5pin=V ⁺ , 6pin=GND	70	90	—	dB
Output Offset Voltage Drift	V _{off}	at Mute ON/OFF	-10	0	10	mV
Mute Voltage	V _{mute}	5pin, at Mute	3.5	—	—	V
Standby Voltage	V _{stb}	6pin, at Standby	—	—	1.0	V

5

■ APPLICATION CIRCUIT

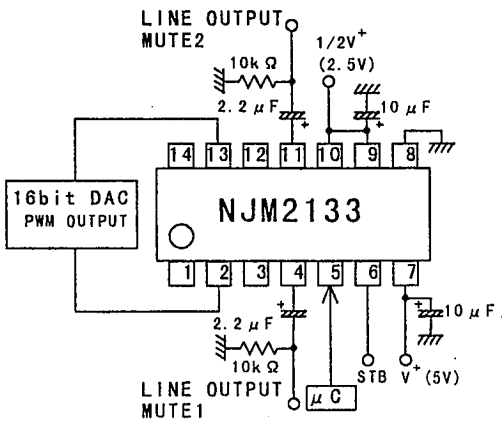

■ POWER ON TIMING CHART

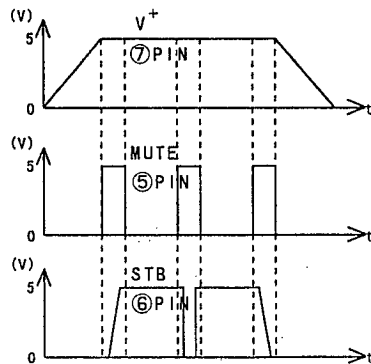

TYPICAL CHARACTERISTICS

Operating Current vs. Operating Voltage
($T_a=25^\circ\text{C}$)

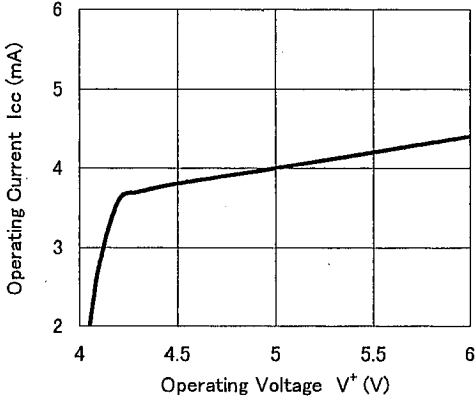

Operating Current vs. Temperature
($V^+=5\text{V}$)

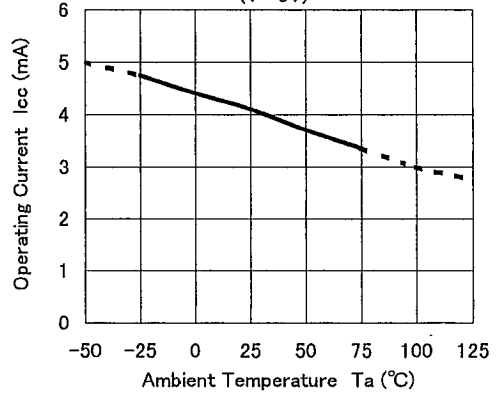

Voltage Gain vs. Frequency
($T_a=25^\circ\text{C}$)

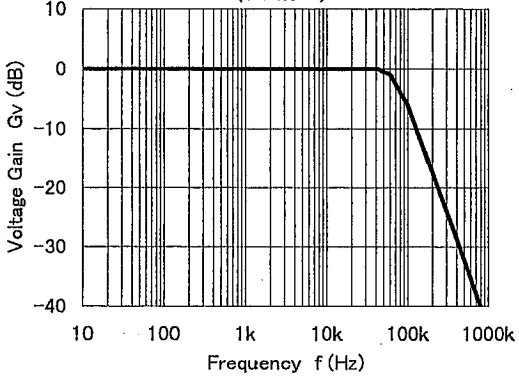

Voltage Gain1 vs. Temperature
($f=100\text{kHz}$)

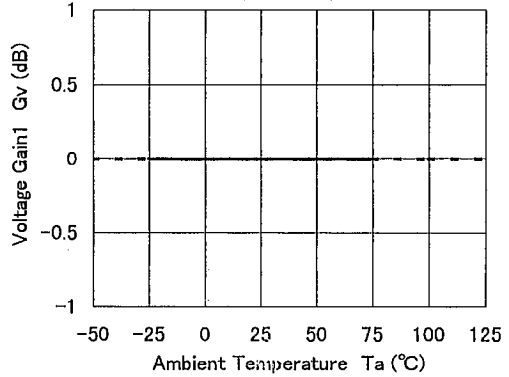

Voltage Gain2 vs. Temperature
($f=1\text{kHz}$)

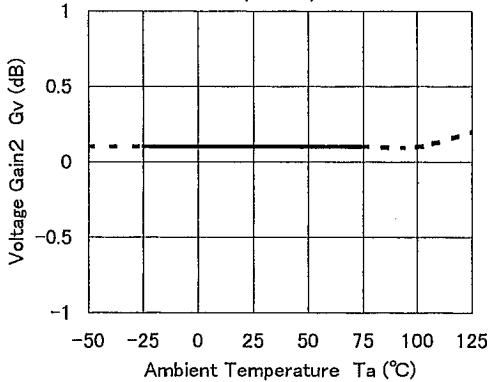

Voltage Gain3 vs. Temperature
($f=1\text{kHz}$)

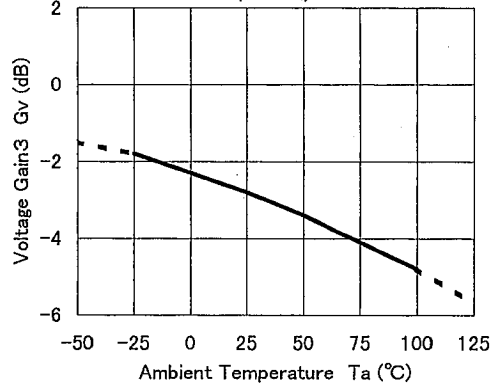

5

■ TYPICAL CHARACTERISTICS

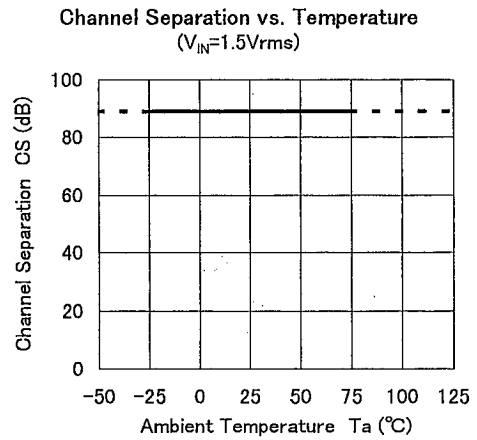
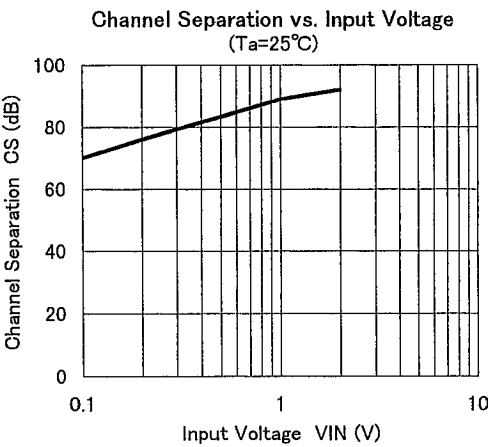
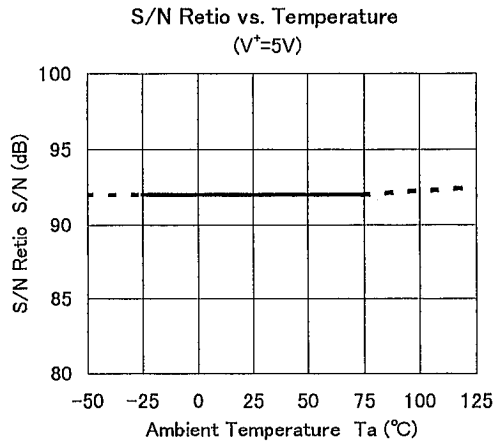
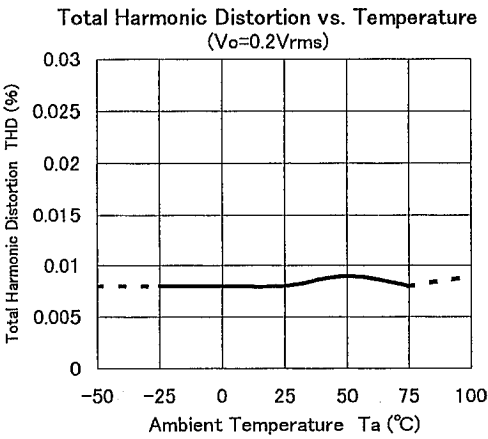
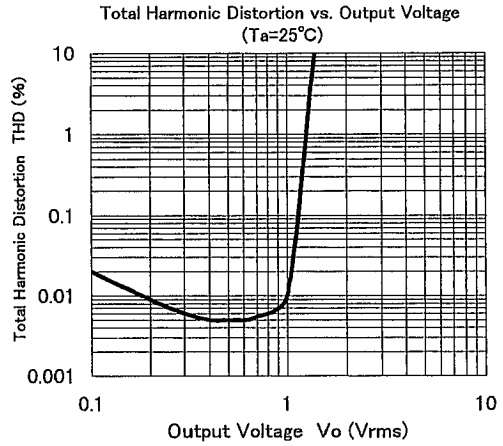
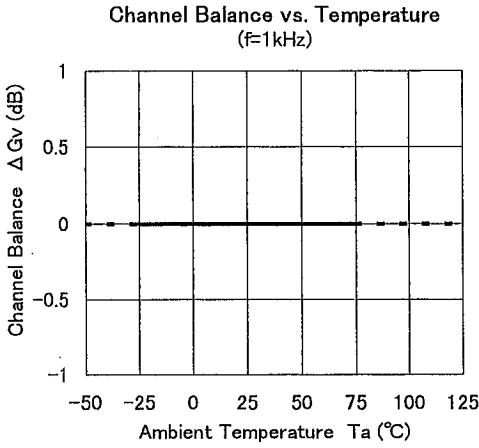

5

TYPICAL CHARACTERISTICS

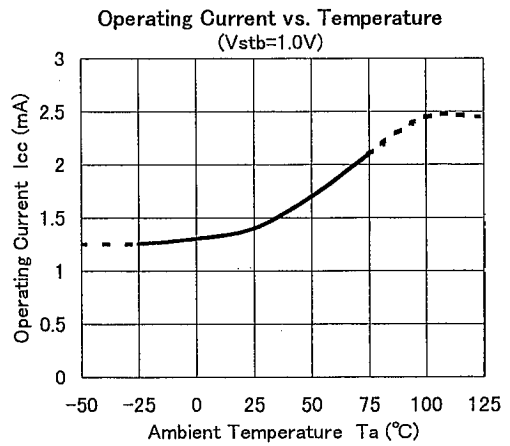
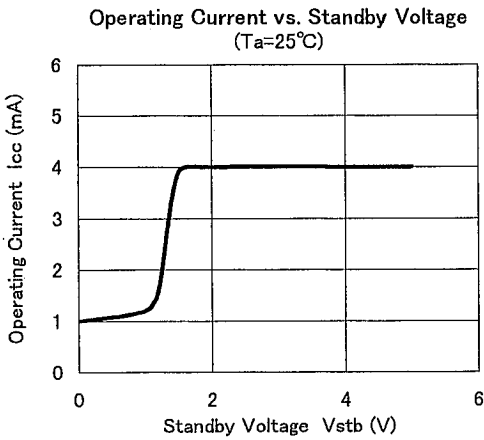
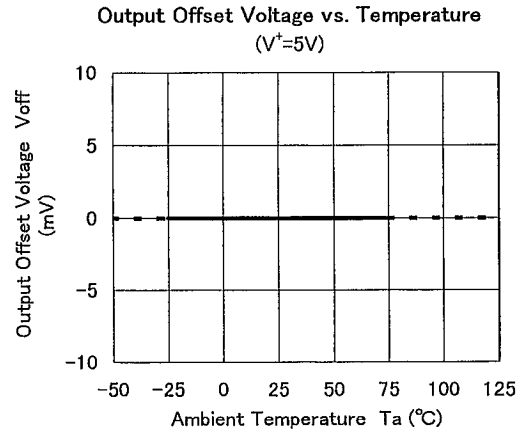
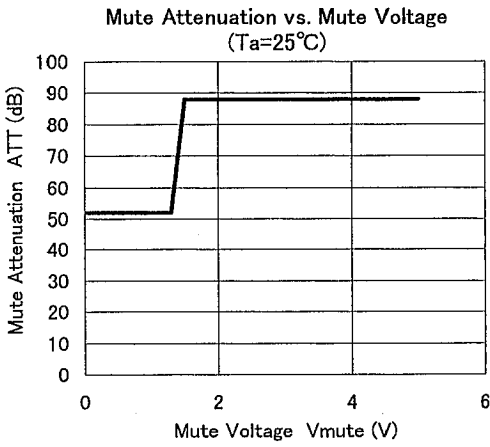
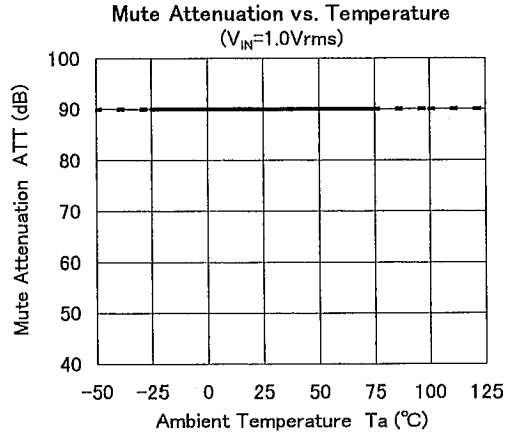
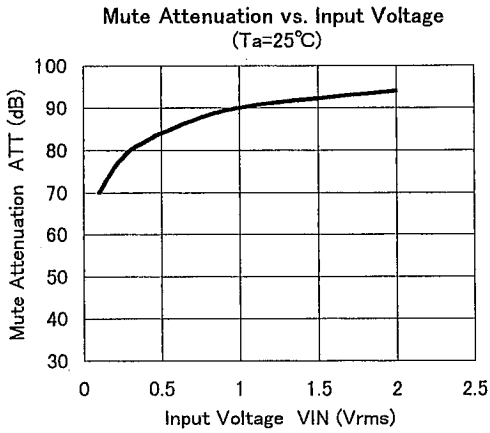

5

MEMO

[CAUTION]

The specifications on this databook are only given for information, without any guarantee as regards either mistakes or omissions. The application circuits in this databook are described only to show representative usages of the product and not intended for the guarantee or permission of any right including the industrial rights.