

SYSTEM RESET IC

■ GENERAL DESCRIPTION

The NJM2102 Possesses two functions. One is to detect a voltage which decays from the desired voltage and generate a warning signal. And also, the NJM2102 holds the warning signal for a certain term after the specified voltage is obtained or recovered. The other one (Watch Dog Timer) is to identify missing clocks of microprocessors. Therefore, it should be said that the NJM2102 is ideal to protect any microprocessors from the fales operations induced by undesired condition.

■ PACKAGE OUTLINE

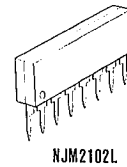
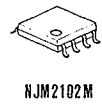
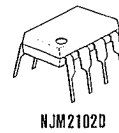

■ FEATURES

- Internal Watch Dog Timer
- Precise Detection of Supply Voltage Down (4.2V ± 2.5%)
- Package Outline DIP8, DMP8, SIP8
- Bipolar Technology

■ PIN CONFIGURATION

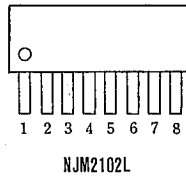
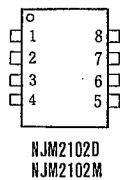

PIN FUNCTION

1. CT
2. RESET
3. CK
4. GND
5. V⁺
6. V_{REF}
7. V_S
8. RESET

■ BLOCK DIAGRAM

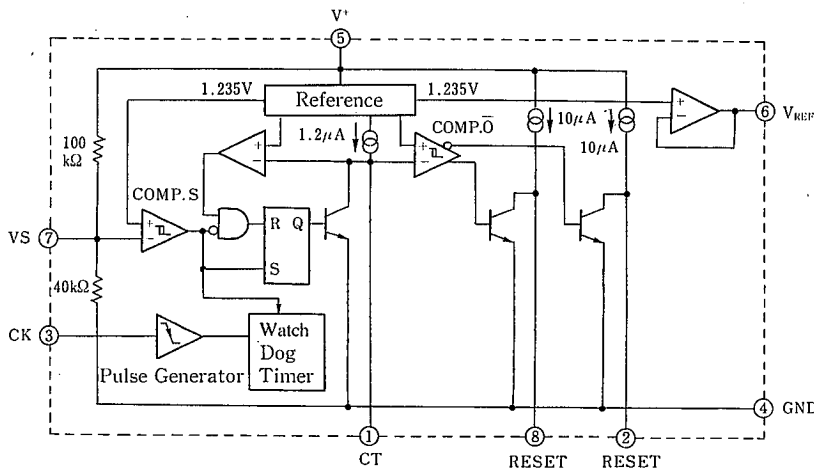

6

■ ABSOLUTE MAXIMUM RATINGS

(Ta=25°C)



PARAMETER	SYMBOL	RATINGS	UNIT
Supply Voltage	V ⁺ _I	13.5	V
Input Voltage	V _S	V ⁺ +0.3(<20)	V
Input Voltage	V _{CK}	20	V
Power Dissipation	P _D	(DIP8) 500	mW
		(SIP8) 600	mW
		(DMP8) 300	mW
Operating Temperature Range	T _{opr}	-40~+85	°C
Storage Temperature Range	T _{stg}	-40~+125	°C

■ ELECTRICAL CHARACTERISTICS

(V⁺=5V, Ta=25°C)

PARAMETER	SYMBOL	CONDITION	MIN.	TYP.	MAX.	UNIT
Operating Current	I _{cc}	Full Function	—	0.65	1.00	mA
Threshold Voltage 1	V _{SL}	Falling Down Input	4.10	4.20	4.30	V
Threshold Voltage 2	V _{SH}	Rising Up Input	4.20	4.30	4.40	V
Hysteresis Width	V _{HYS}	V _{SL} -V _{SH}	50	100	150	mV
Reference Voltage	V _{RFF}		1.217	1.235	1.253	V
Operating Voltage Regulation	ΔV _{REF1}	V _{CC} =3.5V~18V	-10	+3	+10	mV
Load Regulation	ΔV _{REF2}	I _{OUT} =-200μA~+5μA	-5	—	+5	mV
CK Input Threshold Voltage	V _{TH}		0.70	1.24	1.90	V
CK Input Current 1	I _{IH}	V _{CK} =5.0V	—	0	1.0	μA
CK Input Current 2	I _{IL}	V _{CK} =0.0V	-1.0	-0.1	—	μA
C _T Charge Current 1	I _{CTC1}	(Note 1)	20	50	110	μA
C _T Charge Current 2	I _{CTC2}	V _{CK} =0.0V	0.6	1.4	3.0	μA
Capacitor Discharge Current 1	I _{CTD1}	(Note 1)	6	9	13	μA
Capacitor Discharge Current 2	I _{CTD2}	V _{CK} =0.0V	100	600	—	μA
Output Voltage (High) 1	V _{OH1}	V _S =Open, I _{RESET} =-5μA	4.5	4.9	—	V
Output Voltage (High) 2	V _{OH2}	V _S =0V, I _{RESET} =-5μA	4.5	4.9	—	V
Output Voltage (Low) 1	V _{OL1}	V _S =0V, I _{RESET} =3mA	—	0.2	0.4	V
Output Voltage (Low) 2	V _{OL2}	V _S =0V, I _{RESET} =10mA	—	0.3	0.5	V
Output Voltage (Low) 3	V _{OL3}	V _S =Open, I _{RESET} =3mA	—	0.2	0.4	V
Output Voltage (Low) 4	V _{OL4}	V _S =Open, I _{RESET} =10mA	—	0.3	0.5	V
Output Sink Current 1	I _{OL1}	V _S =0V, V _{RESET} =1.0V	20	70	—	mA
Output Sink Current 2	I _{OL2}	V _S =Open, V _{RESET} =1.0V	20	70	—	mA
Minimum Operating Voltage 1	V _{CC1}	V _{RESET} =0.4V, I _{RESET} =0.2mA	—	0.8	1.2	V
Minimum Operating Voltage 2	V _{CC2}	V _{RESET} =V ⁺ -0.1V, R _L =1MΩ	—	0.8	1.2	V

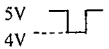
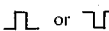
AC CHARACTERISTICS

PARAMETER	SYMBOL	CONDITION	MIN.	TYP.	MAX.	UNIT
V ⁺ Input Pulse Width	T _{PI}	V _{CC} 5V 4V  (Note 2)	—	10	—	μS
CK Input Pulse Width	T _{CKW}	CK  or  (Note 2)	—	1.8	—	mS
CK Input Period	T _{CK}	(Note 2)	—	12	—	mS
Watch Dog Timer	T _{WD}	C _T =0.1μF	—	10	—	mS
Warning Threshold Time						
Watch Dog Timer Reset Pulse Width	T _{WR}	C _T =0.1μF	—	2	—	mS
Reset Signal Hold Time	T _{PR}	C _T =0.1μF	—	100	—	mS
Propagation Delay (RESET Terminal)	T _{PD1}	R _L =2.2kΩ, C _L =100pF	—	2	—	μS
(RESET Terminal)	T _{PD2}	R _L =2.2kΩ, C _L =100pF	—	3	—	μS
Output Rise Time	t _r	R _L =2.2kΩ, C _L =100pF	—	1.0	—	μS
Output Fall Time	t _f	R _L =2.2kΩ, C _L =100pF	—	0.1	—	μS

(Note1) : The specified pulses (Refer to AC Characteristics) are applied to CK-pin.

(Note2) : This characteristics is guaranteed within the design.

■ TIMING CHART

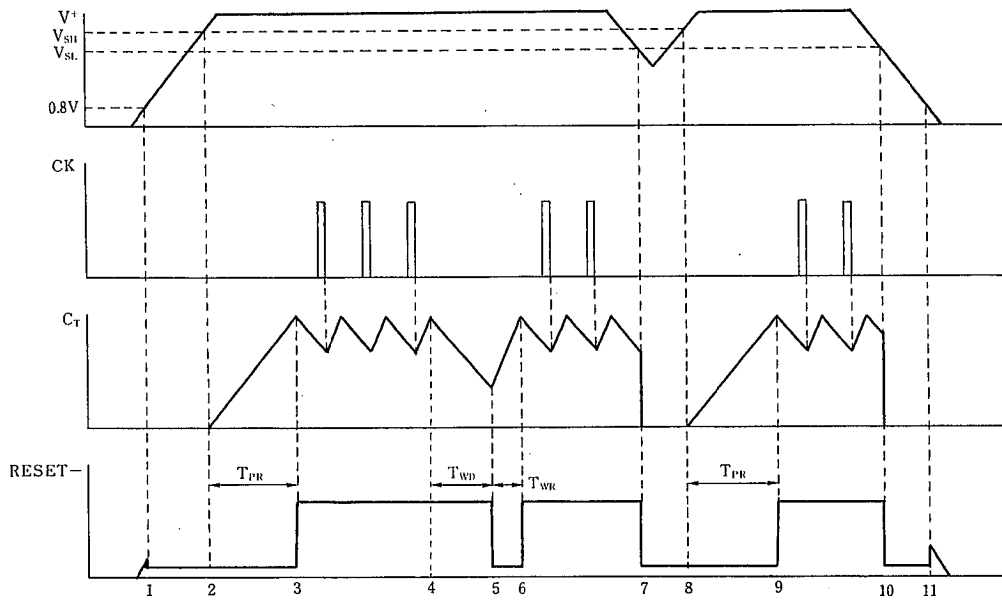

■ TERMINAL FUNCTION

PIN NO.	SYMBOL	FUNCTION	INSIDE EQUIVALENT CIRCUIT
1	C_T	Pin Connection to Capacitor, Set the reset holding time	
2	RESET	Reset Output	
3	CK	Crock Input	

6

■ TERMINAL FUNCTION

PIN NO.	SYMBOL	FUNCTION	INSIDE EQUIVALENT CIRCUIT
4	GND	Ground	
5	V ⁺	Operating Voltage	
6	V _{REF}	Ref Amp Output	
7	V _S	Comparator S Input	
8	RESET	Reset Output Internal pull up resistor	

6

■ TYPICAL CHARACTERISTICS
Operating Current vs. Operating Voltage

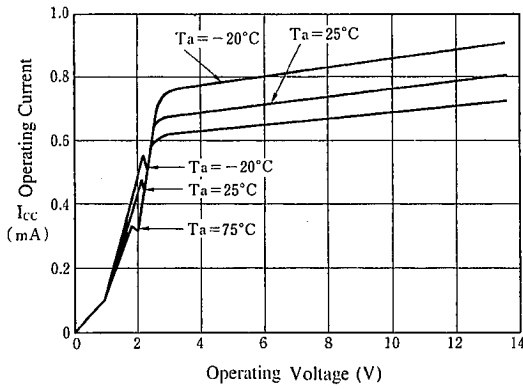

Output Voltage vs. Operating Voltage
(RESET PIN)

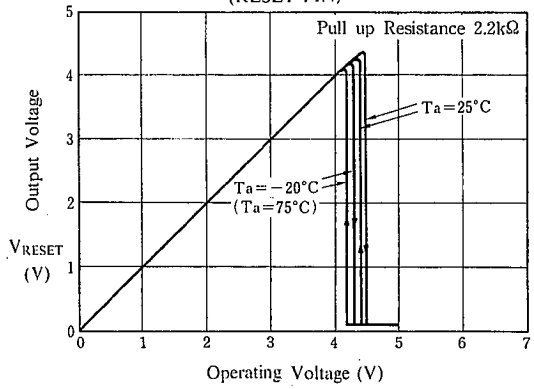

Output Voltage vs. Operating Voltage
(RESET PIN)

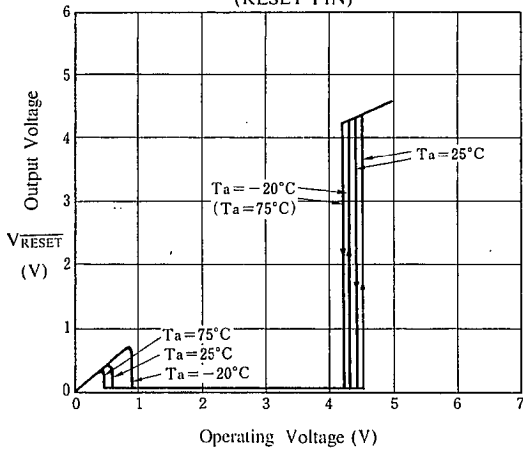

Detect Voltage vs. Ambient Temperature

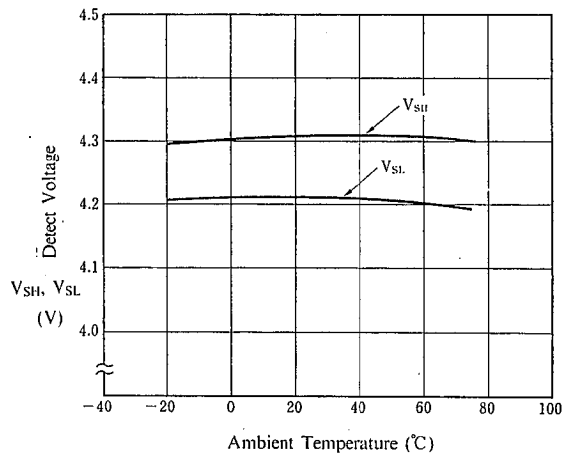

Saturation Voltage vs. Output Sink Current
(RESET PIN)

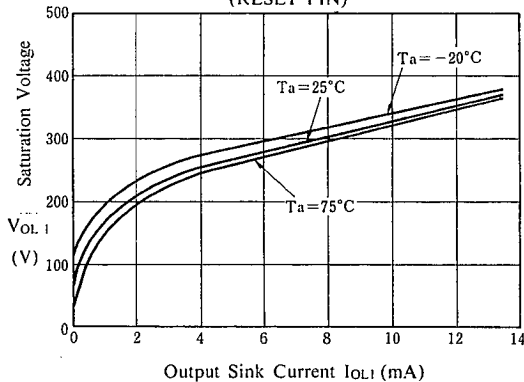

Saturation Voltage vs. Output Sink Current
(RESET PIN)

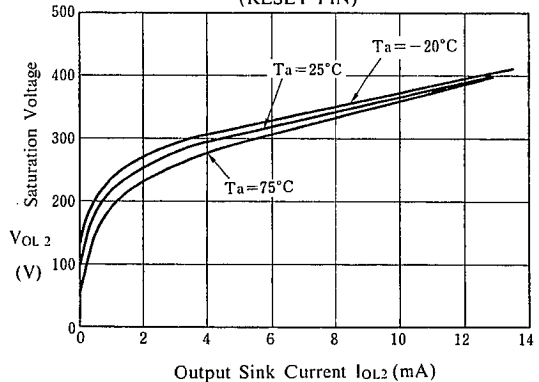

TYPICAL CHARACTERISTICS

High Level Output Voltage vs. High Level Output Current (RESET PIN)

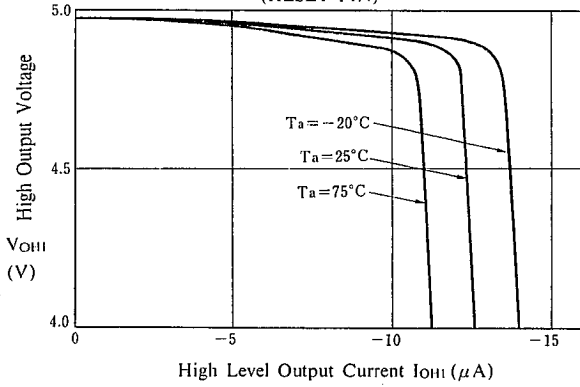

Reference Voltage vs. Reference Current

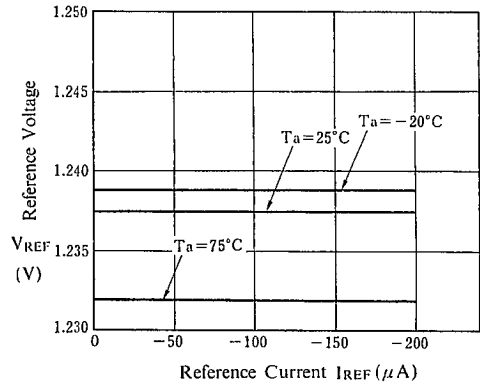

High Output Voltage vs. High Level Output Current (RESET PIN)

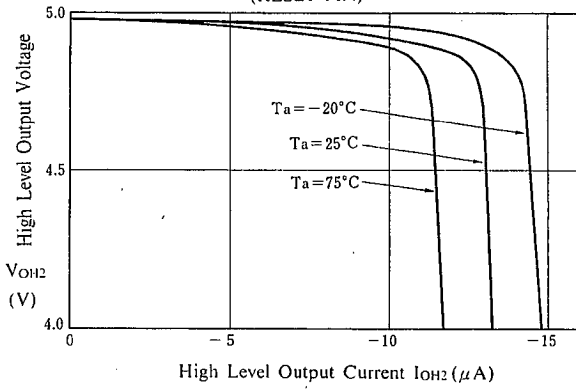

Reference Voltage vs. Ambient Temperature

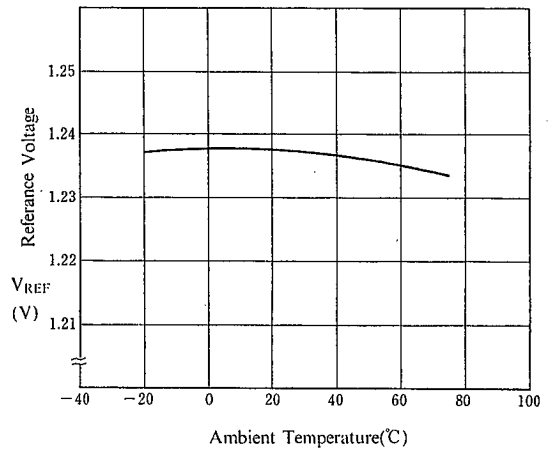

Reference Voltage vs. Operating Voltage

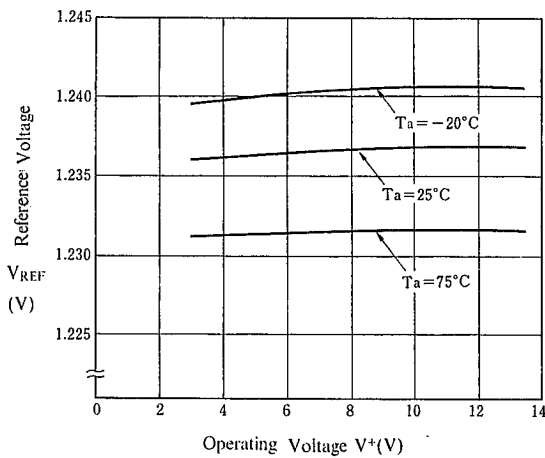

■ TYPICAL CHARACTERISTICS

Reset Hold Time at Transient

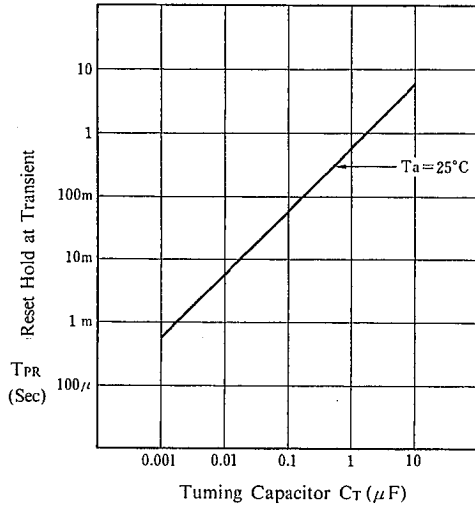

Reset Time

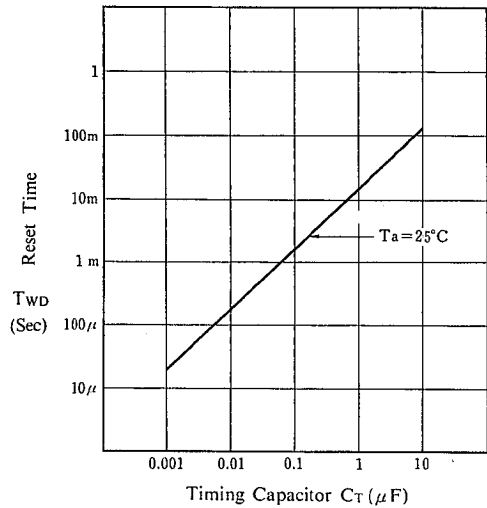

Watch Dog Timer observation time

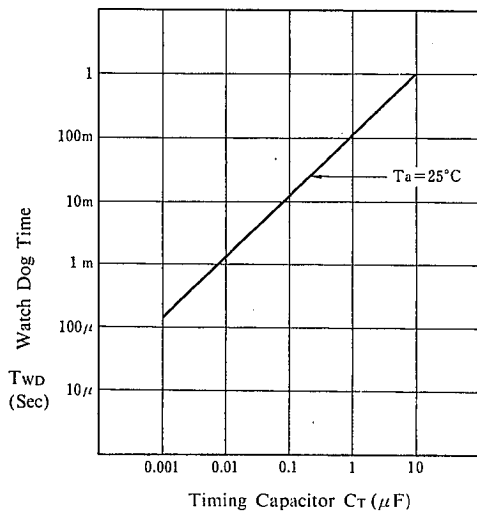

Minimum Input Pulse Width vs. C_T

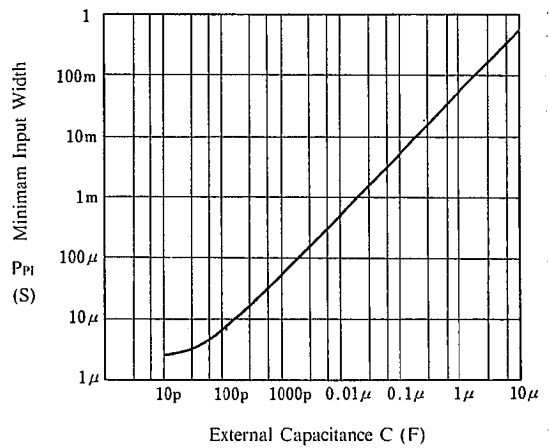

6

■ APPLICATION CIRCUIT

1. 5V Supply Voltage Supervisory and Watch-dog-timer

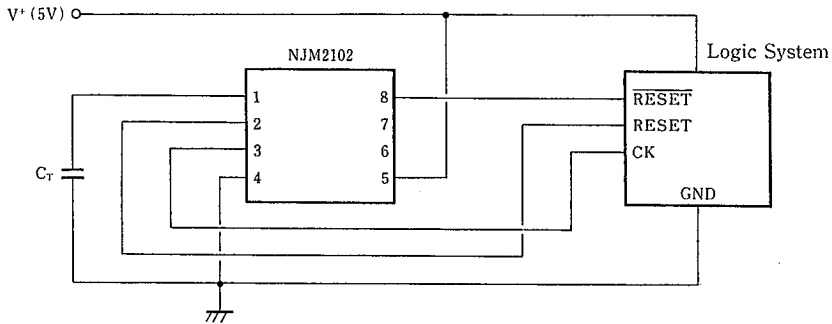

- Voltage Supply is detected through V_s . Detected Voltage is V_{SH} , V_{SL} .

2. 5V Supply Voltage Supervisory (Externally fine tuning type)

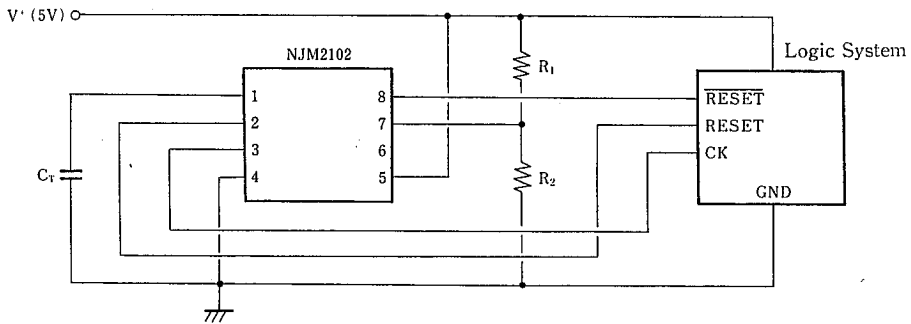

- V_s detecting Voltage can be externally adjusted.
- Detecting Voltage can be decided by divider resistor of IC inside.
Detecting Voltage can be set by external R_1 , R_2 .
The external resistor R_1 , R_2 are required to be set in value less than 1/10 in comparing to dividing resistor of IC inside.
Please refer to following Table.

R_1 (k Ω)	R_2 (k Ω)	Detecting Voltage: V_{SH} (V)	Detecting Voltage: V_{SU} (V)
10	3.9	4.34	4.44
9.1	3.9	4.08	4.18

3. Compulsory Resetting attached (Reset Hold attached)

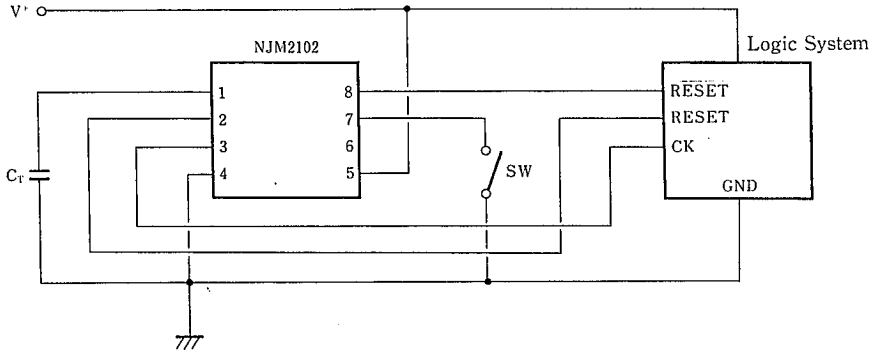

- *Pin 7 to be grounded when SW. ON. RESET(8pin) become Low:
RESET(pin2) become HIGH.!

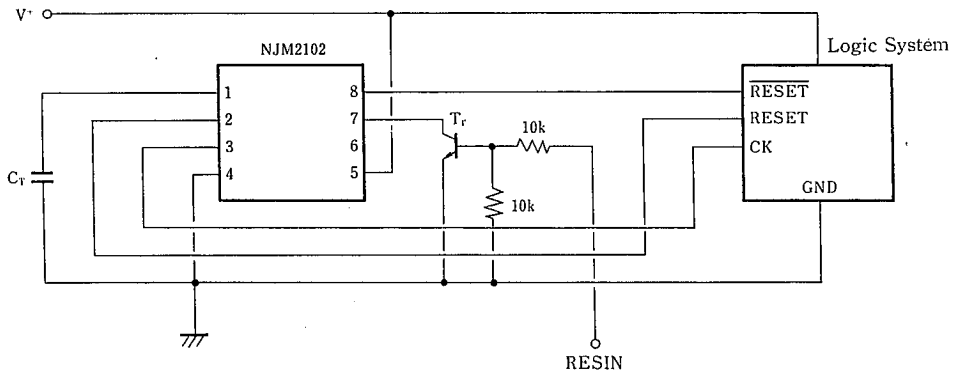

- By putting signal in the RESET pin, and Tr switch ON $\overline{\text{RESET}}$ pin become LOW and RESET pin High.

MEMO

[CAUTION]

The specifications on this databook are only given for information, without any guarantee as regards either mistakes or omissions. The application circuits in this databook are described only to show representative usages of the product and not intended for the guarantee or permission of any right including the industrial rights.