

Cascadable Silicon Bipolar MMIC Amplifier

Technical Data

MSA-0670

Features

- **Cascadable 50 Ω Gain Block**
- **Low Operating Voltage:**
3.5 V Typical V_d
- **3 dB Bandwidth:**
DC to 1.0 GHz
- **High Gain:**
19.5 dB Typical at 0.5 GHz
- **Low Noise Figure:**
2.8 dB Typical at 0.5 GHz
- **Hermetic Gold-ceramic
Microstrip Package**

Description

The MSA-0670 is a high performance silicon bipolar Monolithic Microwave Integrated Circuit (MMIC) housed in a hermetic,

high reliability package. This MMIC is designed for use as a general purpose 50 Ω gain block. Typical applications include narrow and broad band IF and RF amplifiers in industrial and military applications.

The MSA-series is fabricated using HP's 10 GHz f_T , 25 GHz f_{MAX} , silicon bipolar MMIC process which uses nitride self-alignment, ion implantation, and gold metallization to achieve excellent performance, uniformity and reliability. The use of an external bias resistor for temperature and current stability also allows bias flexibility.

70 mil Package

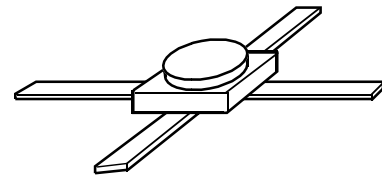

Typical Biasing Configuration

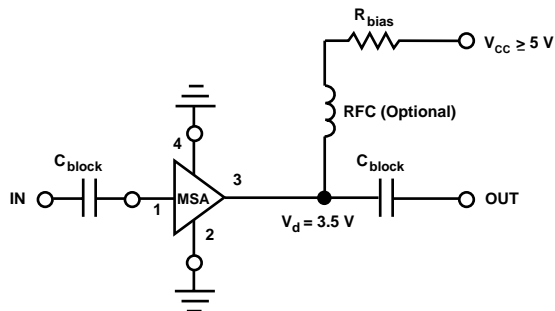

MSA-0670 Absolute Maximum Ratings

Parameter	Absolute Maximum ^[1]
Device Current	50 mA
Power Dissipation ^[2,3]	200 mW
RF Input Power	+13 dBm
Junction Temperature	200°C
Storage Temperature	-65 to 200°C

Thermal Resistance^[2,4]:

$$\theta_{jc} = 130^{\circ}\text{C/W}$$

Notes:

1. Permanent damage may occur if any of these limits are exceeded.
2. $T_{\text{CASE}} = 25^{\circ}\text{C}$.
3. Derate at $7.7 \text{ mW/}^{\circ}\text{C}$ for $T_{\text{C}} > 174^{\circ}\text{C}$.
4. The small spot size of this technique results in a higher, though more accurate determination of θ_{jc} than do alternate methods. See MEASUREMENTS section "Thermal Resistance" for more information.

Electrical Specifications^[1], $T_{\text{A}} = 25^{\circ}\text{C}$

Symbol	Parameters and Test Conditions: $I_{\text{d}} = 16 \text{ mA}$, $Z_{\text{o}} = 50 \Omega$	Units	Min.	Typ.	Max.
G_{P}	Power Gain ($ S_{21} ^2$) $f = 0.1 \text{ GHz}$	dB	19.0	20.5	22.0
ΔG_{P}	Gain Flatness $f = 0.1 \text{ to } 0.6 \text{ GHz}$	dB		± 0.7	± 1.0
$f_{3 \text{ dB}}$	3 dB Bandwidth	GHz		1.0	
VSWR	Input VSWR $f = 0.1 \text{ to } 1.5 \text{ GHz}$			1.9:1	
	Output VSWR $f = 0.1 \text{ to } 1.5 \text{ GHz}$			1.8:1	
NF	50 Ω Noise Figure $f = 0.5 \text{ GHz}$	dB		2.8	4.0
$P_{1 \text{ dB}}$	Output Power at 1 dB Gain Compression $f = 0.5 \text{ GHz}$	dBm		2.0	
IP_3	Third Order Intercept Point $f = 0.5 \text{ GHz}$	dBm		14.5	
t_{D}	Group Delay $f = 0.5 \text{ GHz}$	psec		200	
V_{d}	Device Voltage	V	3.1	3.5	3.9
dV/dT	Device Voltage Temperature Coefficient	mV/ $^{\circ}\text{C}$		-8.0	

Note:

1. The recommended operating current range for this device is 12 to 30 mA. Typical performance as a function of current is on the following page.

MSA-0670 Typical Scattering Parameters ($Z_0 = 50 \Omega$, $T_A = 25^\circ\text{C}$, $I_d = 16 \text{ mA}$)

Freq. GHz	S ₁₁		S ₂₁			S ₁₂			S ₂₂		k
	Mag	Ang	dB	Mag	Ang	dB	Mag	Ang	Mag	Ang	
0.1	.05	-147	20.5	10.62	172	-23.3	.068	4	.05	-69	1.05
0.2	.07	-134	20.4	10.41	164	-23.0	.070	8	.09	-92	1.04
0.3	.09	-126	20.1	10.16	156	-22.6	.074	12	.13	-104	1.02
0.4	.11	-123	19.9	9.85	148	-22.4	.076	14	.16	-113	1.00
0.5	.13	-123	19.6	9.50	141	-22.0	.079	26	.20	-121	0.99
0.6	.15	-123	19.2	9.09	135	-21.3	.082	18	.22	-128	0.97
0.8	.19	-126	17.4	8.28	122	-20.7	.093	22	.25	-141	0.94
1.0	.24	-129	16.5	7.46	110	-19.8	.103	22	.27	-154	0.92
1.5	.31	-141	15.2	5.76	87	-18.2	.124	23	.27	-176	0.91
2.0	.38	-157	13.0	4.47	68	-17.2	.138	19	.24	166	0.94
2.5	.42	-167	11.1	3.59	57	-16.7	.146	20	.21	158	1.01
3.0	.46	178	9.5	2.97	45	-16.4	.152	16	.17	156	1.07
3.5	.48	173	7.9	2.49	33	-16.2	.155	11	.14	163	1.15
4.0	.48	164	6.6	2.13	22	-16.1	.156	9	.11	-175	1.27
4.5	.48	155	5.5	1.87	13	-15.9	.161	5	.11	-154	1.35
5.0	.48	143	4.5	1.67	3	-15.8	.163	3	.14	-141	1.46

Note:

1. A model for this device is available in the DEVICE MODELS section.

Typical Performance, $T_A = 25^\circ\text{C}$

(unless otherwise noted)

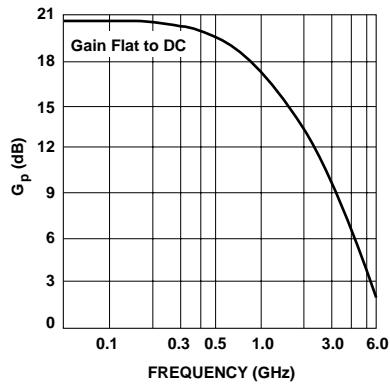

Figure 1. Typical Power Gain vs. Frequency, $T_A = 25^\circ\text{C}$, $I_d = 16 \text{ mA}$.

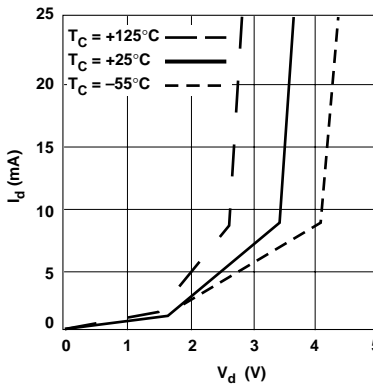

Figure 2. Device Current vs. Voltage.

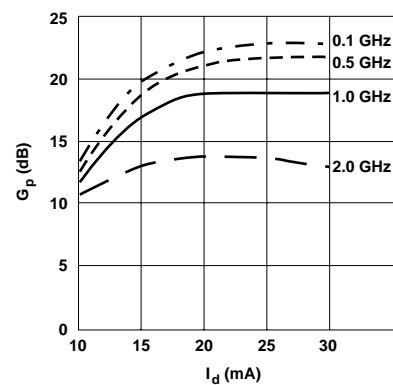

Figure 3. Power Gain vs. Current.

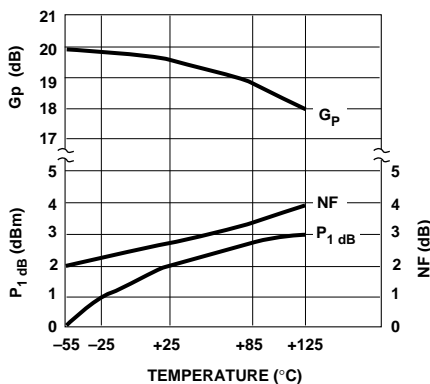

Figure 4. Output Power at 1 dB Gain Compression, NF and Power Gain vs. Case Temperature, $f = 0.5 \text{ GHz}$, $I_d = 16 \text{ mA}$.

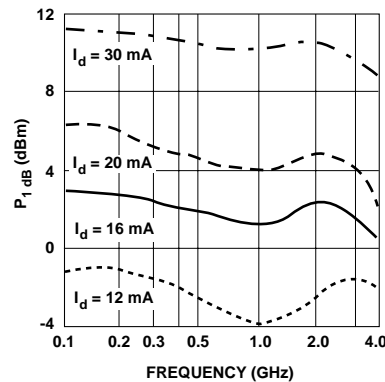

Figure 5. Output Power at 1 dB Gain Compression vs. Frequency.

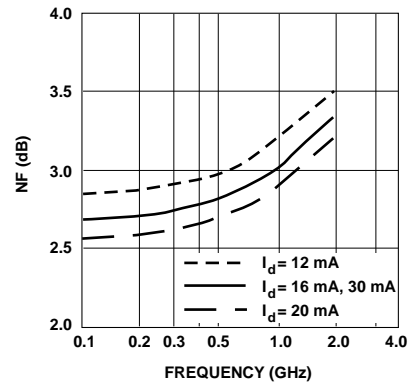

Figure 6. Noise Figure vs. Frequency.

70 mil Package Dimensions

