



L88MS00T Series

4 to 12 V, 0.5 A Low Dropout Voltage Regulator with On/Off Function

Overview

The L88MS00T Series has an on-chip on/off function to maximize equipment power saving effectiveness. Because it can operate with a low input-output voltage difference, it contributes to smaller and more efficient set power supplies, optimum for audio-visual and office automation equipment.

Functions

- Output voltage L88MS04T: 4 V L88MS05T: 5 V
L88MS06T: 6 V L88MS08T: 8 V
L88MS09T: 9 V L88MS12T: 12 V
- On/off control of output voltage by strobe pin (active low)
- 500 mA output current

Features

- Low minimum input-output voltage differential (0.4 V typ) enables to save energy and miniaturize transformer size.
- Quiescent current is low with output off (L88MS05T/ $I_{Q\ OFF}$ = 40 μ A typ, except I_{STB}).
- Set size can be miniaturized with compact TP-5H power package.
- Surface mounting on board permits allowable power dissipation to be raised.
- Enhanced mount flexibility with range of formed products.
- On-chip protective circuitry (fold back short circuit, thermal over load).
- External noise suppression pin provided.

Package Dimensions

unit : mm

3103-TP-5H

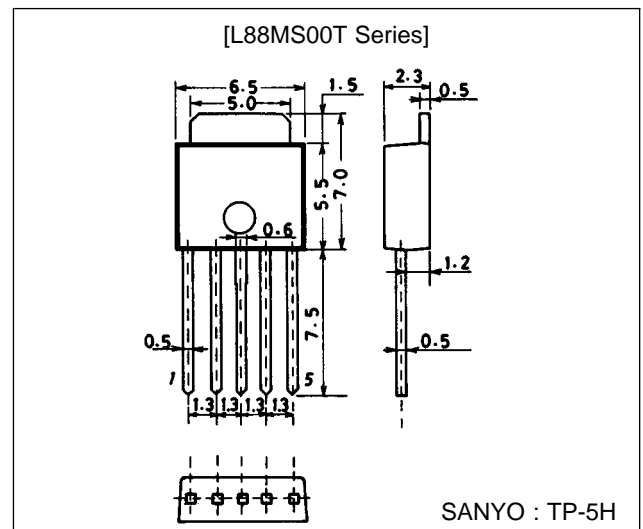

Pin Assignment

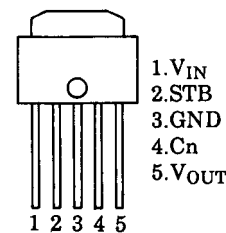

Top view

Specifications

Maximum Ratings at $T_a = 25^\circ\text{C}$ (common to L88MS00T series)

Parameter	Symbol	Conditions	Ratings	Unit
Input voltage	$V_{IN\ max}$		18	V
Strobe pin input voltage	$V_{ST\ max}$		$V_{IN\ max}$	V
Allowable power dissipation	$P_d\ max$	$T_a \leq 25^\circ\text{C}$, no heat sink	1	W
		$T_c = 25^\circ\text{C}$, with infinite heat sink	6.25	W
Thermal resistance (junction-atmosphere)	θ_{j-a}		125	$^\circ\text{C/W}$
Thermal resistance (junction-to-case)	θ_{j-c}		20	$^\circ\text{C/W}$
Operating temperature	T_{opr}		-20 to +85	$^\circ\text{C}$
Storage temperature	T_{stg}		-55 to +150	$^\circ\text{C}$

L88MS00T Series

[L88MS04T]

Operating Conditions at $T_a = 25\text{ }^\circ\text{C}$

Parameter	Symbol	Conditions	Ratings	Unit
Input voltage	V_{IN}		4.7 to 17	V
Output current	I_{OUT}		0 to 500	mA
Output on control voltage	V_{STL}		-0.3 to +0.8	V
Output off control voltage	V_{STH}		2.0 to V_{IN}	V

Operating Characteristics at $T_j = 25\text{ }^\circ\text{C}$, $V_{IN} = 7\text{ V}$, $I_O = 500\text{ mA}$, $C_{OUT} = 100\text{ }\mu\text{F}$, C_{IN} , $C_n = 1\text{ }\mu\text{F}$, see specified Test Circuit.

Parameter	Symbol	Conditions	min	typ	max	Unit
[Output on, $V_{ST} = \text{"L"}$]						
Output voltage	V_{OUT}		3.88	4.0	4.12	V
Dropout voltage	V_{DROP1}			0.4	0.6	V
	V_{DROP2}	$I_O = 150\text{ mA}$		0.2	0.3	V
Line regulation	ΔV_{OLN}	$4.7\text{ V} \leq V_{IN} \leq 17\text{ V}$		10	50	mV
Load regulation	ΔV_{OLD}	$5\text{ mA} \leq I_{OUT} \leq 500\text{ mA}$		24	80	mV
Peak output current	I_{OP}		600	900		mA
Output short-circuit current	I_{OSC}			100	300	mA
Quiescent current	I_{Q1}	$I_{OUT} = 0$		1.9	5.0	mA
	I_{Q2}			24	50	mA
Output noise voltage	V_{NO}	$10\text{ Hz} \leq f \leq 100\text{ kHz}$		30		μVrms
Temperature coefficient of output voltage	$\Delta V_{OUT}/\Delta T_j$	$T_j = 25\text{ to }125\text{ }^\circ\text{C}$		± 0.4		$\text{mV}/^\circ\text{C}$
Ripple rejection	Rrej	$f = 120\text{ Hz}$, $5\text{ V} \leq V_{IN} \leq 17\text{ V}$		72		dB
Output on control voltage	V_{STL}				0.8	V
[Output off, $V_{ST} = \text{"H"}$]						
Low output voltage	$V_{O\text{ OFF}}$	$V_{ST} = 5\text{ V}$		20	200	mV
Static current	$I_{Q\text{ OFF}}$	$V_{ST} = 5\text{ V}$, Except I_{STB}		35	70	μA
Output off control voltage	V_{STH}		2.0		V_{IN}	V

[L88MS05T]

Operating Conditions at $T_a = 25\text{ }^\circ\text{C}$

Parameter	Symbol	Conditions	Ratings	Unit
Input voltage	V_{IN}		5.8 to 17	V
Output current	I_{OUT}		0 to 500	mA
Output on control voltage	V_{STL}		-0.3 to +0.8	V
Output off control voltage	V_{STH}		2.0 to V_{IN}	V

L88MS00T Series

Operating Characteristics at $T_j = 25\text{ }^\circ\text{C}$, $V_{IN} = 8\text{ V}$, $I_O = 500\text{ mA}$, $C_{OUT} = 100\text{ }\mu\text{F}$, C_{IN} , $C_n = 1\text{ }\mu\text{F}$, see specified Test Circuit.

Parameter	Symbol	Conditions	min	typ	max	Unit
[Output on, $V_{ST} = \text{"L"}$]						
Output voltage	V_{OUT}		4.85	5.0	5.15	V
Dropout voltage	V_{DROP1}			0.4	0.6	V
	V_{DROP2}	$I_O = 150\text{ mA}$		0.2	0.3	V
Line regulation	ΔV_{OLN}	$5.8\text{ V} \leq V_{IN} \leq 17\text{ V}$		10	50	mV
Load regulation	ΔV_{OLD}	$5\text{ mA} \leq I_{OUT} \leq 500\text{ mA}$		30	100	mV
Peak output current	I_{OP}		600	900		mA
Output short-circuit current	I_{OSC}			100	300	mA
Quiescent current	I_{Q1}	$I_{OUT} = 0$		2.0	5.0	mA
	I_{Q2}			24	50	mA
Output noise voltage	V_{NO}	$10\text{ Hz} \leq f \leq 100\text{ kHz}$		40		μVrms
Temperature coefficient of output voltage	$\Delta V_{OUT}/\Delta T_j$	$T_j = 25\text{ to }125\text{ }^\circ\text{C}$		± 0.5		mV/ $^\circ\text{C}$
Ripple rejection	Rrej	$f = 120\text{ Hz}$, $6\text{ V} \leq V_{IN} \leq 17\text{ V}$		74		dB
Output on control voltage	V_{STL}				0.8	V
[Output off, $V_{ST} = \text{"H"}$]						
Low output voltage	$V_{O\ OFF}$	$V_{ST} = 5\text{ V}$		20	200	mV
Static current	$I_{Q\ OFF}$	$V_{ST} = 5\text{ V}$, Except I_{STB}		40	80	μA
Output off control voltage	V_{STH}		2.0		V_{IN}	V

[L88MS06T]

Operating Conditions at $T_a = 25\text{ }^\circ\text{C}$

Parameter	Symbol	Conditions	Ratings	Unit
Input voltage	V_{IN}		6.8 to 17	V
Output current	I_{OUT}		0 to 500	mA
Output on control voltage	V_{STL}		-0.3 to +0.8	V
Output off control voltage	V_{STH}		2.0 to V_{IN}	V

Operating Characteristics at $T_j = 25\text{ }^\circ\text{C}$, $V_{IN} = 9\text{ V}$, $I_O = 500\text{ mA}$, $C_{OUT} = 100\text{ }\mu\text{F}$, C_{IN} , $C_n = 1\text{ }\mu\text{F}$, see specified Test Circuit.

Parameter	Symbol	Conditions	min	typ	max	Unit
[Output on, $V_{ST} = \text{"L"}$]						
Output voltage	V_{OUT}		5.82	6.0	6.18	V
Dropout voltage	V_{DROP1}			0.4	0.6	V
	V_{DROP2}	$I_O = 150\text{ mA}$		0.2	0.3	V
Line regulation	ΔV_{OLN}	$6.8\text{ V} \leq V_{IN} \leq 17\text{ V}$		10	50	mV
Load regulation	ΔV_{OLD}	$5\text{ mA} \leq I_{OUT} \leq 500\text{ mA}$		36	120	mV
Peak output current	I_{OP}		600	900		mA
Output short-circuit current	I_{OSC}			100	300	mA
Quiescent current	I_{Q1}	$I_{OUT} = 0$		2.1	5.0	mA
	I_{Q2}			24	50	mA
Output noise voltage	V_{NO}	$10\text{ Hz} \leq f \leq 100\text{ kHz}$		40		μVrms
Temperature coefficient of output voltage	$\Delta V_{OUT}/\Delta T_j$	$T_j = 25\text{ to }125\text{ }^\circ\text{C}$		± 0.6		mV/ $^\circ\text{C}$
Ripple rejection	Rrej	$f = 120\text{ Hz}$, $7\text{ V} \leq V_{IN} \leq 17\text{ V}$		76		dB
Output on control voltage	V_{STL}				0.8	V
[Output off, $V_{ST} = \text{"H"}$]						
Low output voltage	$V_{O\ OFF}$	$V_{ST} = 5\text{ V}$		20	200	mV
Static current	$I_{Q\ OFF}$	$V_{ST} = 5\text{ V}$, Except I_{STB}		60	120	μA
Output off control voltage	V_{STH}		2.0		V_{IN}	V

L88MS00T Series

[L88MS08T]

Operating Conditions at $T_a = 25\text{ }^\circ\text{C}$

Parameter	Symbol	Conditions	Ratings	Unit
Input voltage	V_{IN}		8.8 to 17	V
Output current	I_{OUT}		0 to 500	mA
Output on control voltage	V_{STL}		-0.3 to +0.8	V
Output off control voltage	V_{STH}		2.0 to V_{IN}	V

Operating Characteristics at $T_j = 25\text{ }^\circ\text{C}$, $V_{IN} = 11\text{ V}$, $I_O = 500\text{ mA}$, $C_{OUT} = 100\text{ }\mu\text{F}$, C_{IN} , $C_n = 1\text{ }\mu\text{F}$, see specified Test Circuit.

Parameter	Symbol	Conditions	min	typ	max	Unit
[Output on, $V_{ST} = \text{"L"}$]						
Output voltage	V_{OUT}		7.76	8.0	8.24	V
Dropout voltage	V_{DROP1}			0.4	0.6	V
	V_{DROP2}	$I_O = 150\text{ mA}$		0.2	0.3	V
Line regulation	ΔV_{OLN}	$8.8\text{ V} \leq V_{IN} \leq 17\text{ V}$		10	50	mV
Load regulation	ΔV_{OLD}	$5\text{ mA} \leq I_{OUT} \leq 500\text{ mA}$		48	160	mV
Peak output current	I_{OP}		600	900		mA
Output short-circuit current	I_{OSC}			100	300	mA
Quiescent current	I_{Q1}	$I_{OUT} = 0$		2.2	5.0	mA
	I_{Q2}			24	50	mA
Output noise voltage	V_{NO}	$10\text{ Hz} \leq f \leq 100\text{ kHz}$		40		μVrms
Temperature coefficient of output voltage	$\Delta V_{OUT}/\Delta T_j$	$T_j = 25\text{ to }125\text{ }^\circ\text{C}$		± 0.8		$\text{mV}/^\circ\text{C}$
Ripple rejection	Rrej	$f = 120\text{ Hz}$, $9\text{ V} \leq V_{IN} \leq 17\text{ V}$		76		dB
Output on control voltage	V_{STL}				0.8	V
[Output off, $V_{ST} = \text{"H"}$]						
Low output voltage	$V_{O\ OFF}$	$V_{ST} = 5\text{ V}$		20	200	mV
Static current	$I_{Q\ OFF}$	$V_{ST} = 5\text{ V}$, Except I_{STB}		150	300	μA
Output off control voltage	V_{STH}		2.0		V_{IN}	V

[L88MS09T]

Operating Conditions at $T_a = 25\text{ }^\circ\text{C}$

Parameter	Symbol	Conditions	Ratings	Unit
Input voltage	V_{IN}		9.9 to 17	V
Output current	I_{OUT}		0 to 500	mA
Output on control voltage	V_{STL}		-0.3 to +0.8	V
Output off control voltage	V_{STH}		2.0 to V_{IN}	V

L88MS00T Series

Operating Characteristics at $T_j = 25\text{ }^\circ\text{C}$, $V_{IN} = 12\text{ V}$, $I_O = 500\text{ mA}$, $C_{OUT} = 100\text{ }\mu\text{F}$, C_{IN} , $C_n = 1\text{ }\mu\text{F}$, see specified Test Circuit.

Parameter	Symbol	Conditions	min	typ	max	Unit
[Output on, $V_{ST} = \text{"L"}$]						
Output voltage	V_{OUT}		8.73	9.0	9.27	V
Dropout voltage	V_{DROPI}			0.4	0.6	V
	V_{DROPII}	$I_O = 150\text{ mA}$		0.2	0.3	V
Line regulation	ΔV_{OLN}	$9.9\text{ V} \leq V_{IN} \leq 17\text{ V}$		10	50	mV
Load regulation	ΔV_{OLD}	$5\text{ mA} \leq I_{OUT} \leq 500\text{ mA}$		54	180	mV
Peak output current	I_{OP}		600	900		mA
Output short-circuit current	I_{OSC}			100	300	mA
Quiescent current	I_{Q1}	$I_{OUT} = 0$		2.3	5.0	mA
	I_{Q2}			24	50	mA
Output noise voltage	V_{NO}	$10\text{ Hz} \leq f \leq 100\text{ kHz}$		40		μVrms
Temperature coefficient of output voltage	$\Delta V_{OUT}/\Delta T_j$	$T_j = 25\text{ to }125\text{ }^\circ\text{C}$		± 0.9		mV/ $^\circ\text{C}$
Ripple rejection	Rrej	$f = 120\text{ Hz}$, $10\text{ V} \leq V_{IN} \leq 17\text{ V}$		76		dB
Output on control voltage	V_{STL}				0.8	V
[Output off, $V_{ST} = \text{"H"}$]						
Low output voltage	$V_{O\text{ OFF}}$	$V_{ST} = 5\text{ V}$		20	200	mV
Static current	$I_{Q\text{ OFF}}$	$V_{ST} = 5\text{ V}$, Except I_{STB}		200	400	μA
Output off control voltage	V_{STH}		2.0		V_{IN}	V

[L88MS12T]

Operating Conditions at $T_a = 25\text{ }^\circ\text{C}$

Parameter	Symbol	Conditions	Ratings	Unit
Input voltage	V_{IN}		13 to 17	V
Output current	I_{OUT}		0 to 500	mA
Output on control voltage	V_{STL}		-0.3 to +0.8	V
Output off control voltage	V_{STH}		2.0 to V_{IN}	V

Operating Characteristics at $T_j = 25\text{ }^\circ\text{C}$, $V_{IN} = 15\text{ V}$, $I_O = 500\text{ mA}$, $C_{OUT} = 100\text{ }\mu\text{F}$, C_{IN} , $C_n = 1\text{ }\mu\text{F}$, see specified Test Circuit.

Parameter	Symbol	Conditions	min	typ	max	Unit
[Output on, $V_{ST} = \text{"L"}$]						
Output voltage	V_{OUT}		11.64	12.0	12.36	V
Dropout voltage	V_{DROPI}			0.4	0.6	V
	V_{DROPII}	$I_O = 150\text{ mA}$		0.2	0.3	V
Line regulation	ΔV_{OLN}	$13\text{ V} \leq V_{IN} \leq 17\text{ V}$		10	50	mV
Load regulation	ΔV_{OLD}	$5\text{ mA} \leq I_{OUT} \leq 500\text{ mA}$		70	240	mV
Peak output current	I_{OP}		600	900		mA
Output short-circuit current	I_{OSC}			100	300	mA
Quiescent current	I_{Q1}	$I_{OUT} = 0$		2.6	5.0	mA
	I_{Q2}			24	50	mA
Output noise voltage	V_{NO}	$10\text{ Hz} \leq f \leq 100\text{ kHz}$		40		μVrms
Temperature coefficient of output voltage	$\Delta V_{OUT}/\Delta T_j$	$T_j = 25\text{ to }125\text{ }^\circ\text{C}$		± 1.2		mV/ $^\circ\text{C}$
Ripple rejection	Rrej	$f = 120\text{ Hz}$, $13\text{ V} \leq V_{IN} \leq 17\text{ V}$		76		dB
Output on control voltage	V_{STL}				0.8	V
[Output off, $V_{ST} = \text{"H"}$]						
Low output voltage	$V_{O\text{ OFF}}$	$V_{ST} = 5\text{ V}$		20	200	mV
Static current	$V_{Q\text{ OFF}}$	$V_{ST} = 5\text{ V}$, Except I_{STB}		500	1000	μA
Output off control voltage	V_{STH}		2.0		V_{IN}	V

L88MS00T Series

Equivalent Circuit Block Diagram

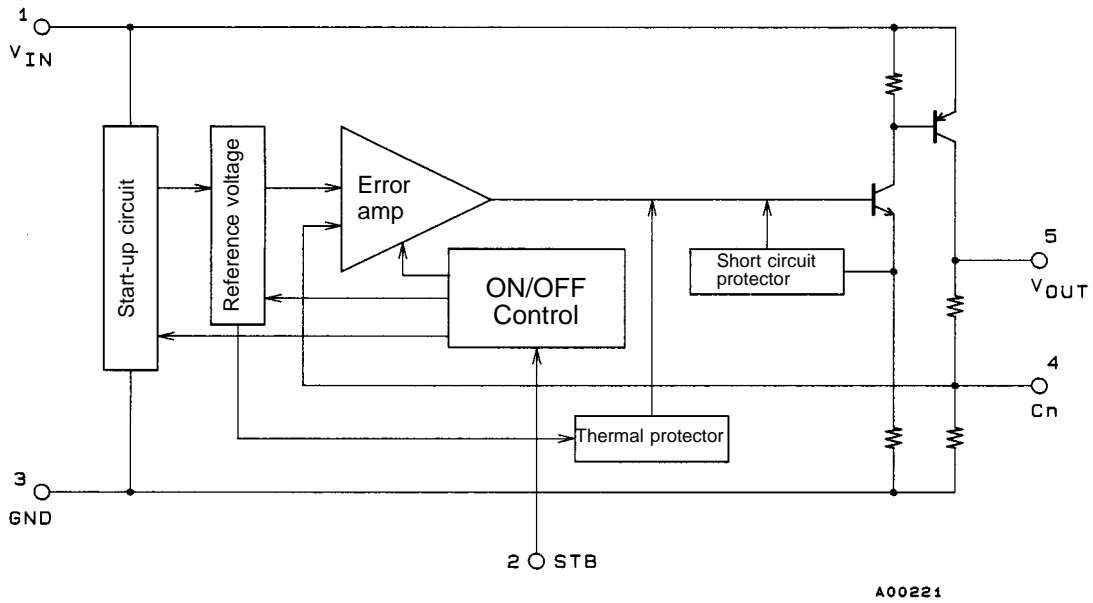

Test Circuit (Common to L88MS00T Series)

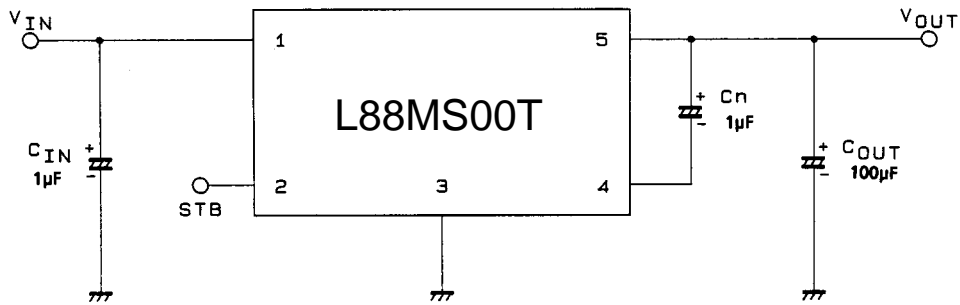

- Notes:
1. Because the output capacitor C_{OUT} is set at over $100\ \mu\text{F}$ to prevent oscillation at low temperatures, a capacitor that exhibits little change in capacity with temperature variations should be used (such as a tantalum capacitor).
 2. Adding capacitor C_n enables external noise suppression and ripple rejection to be improved. However, attention should be given to system stability (phase margin).
 3. To ensure operational stability, C_{IN} , C_{OUT} , and C_n should be placed as close to the IC as possible.
 4. When the strobe (STB) pin is open, output is turned on by internal bias. When the strobe function is not used, the STB pin should be connected to GND to complete strobe operation.
 5. When V_{IN} is minus (-) and GND is plus (+) (reversed connection), excessive current flow will occur.

L88MS00T Series

Function Table

V _{STB}	V _{OUT}
L	H
H	L

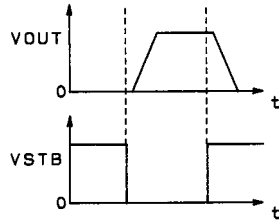

A00223

On/off Control Input Equivalent Circuit

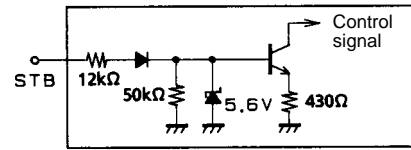

A00233

Sample Application Circuit

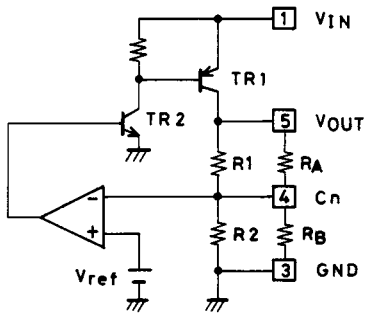

Adjustment of output voltage V_{OUT}

- (1) Reducing V_{OUT}
V_{OUT} can be lowered by externally connecting a resistor R_A between the C_n and V_{OUT} pins.
- (2) Increasing V_{OUT}
V_{OUT} can be raised by externally connecting a resistor R_B between the C_n and GND pins.

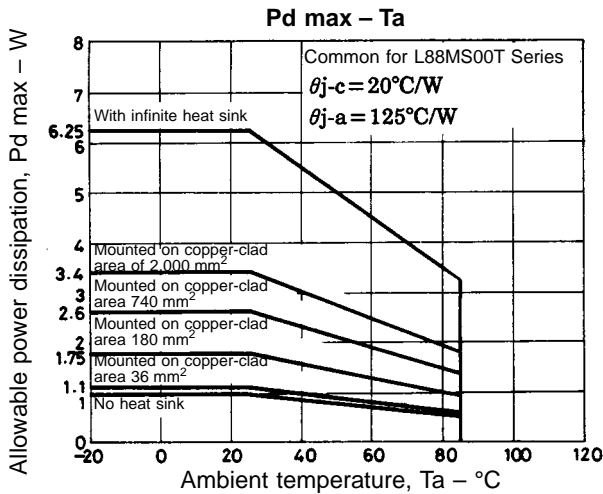

The allowable power dissipation is 1.0 W (Ta = 25°C) with no fin attached, but when mounted on a hybrid IC board or printed circuit board, high allowable power dissipation is achieved, despite the compact package. The graph below depicts the relationship between the copper-clad area and allowable power dissipation when mounted on a glass epoxy board (50 × 5.0 × 0.8 tmm³) with a copper thickness of 18 μm.

L88MS00T Series

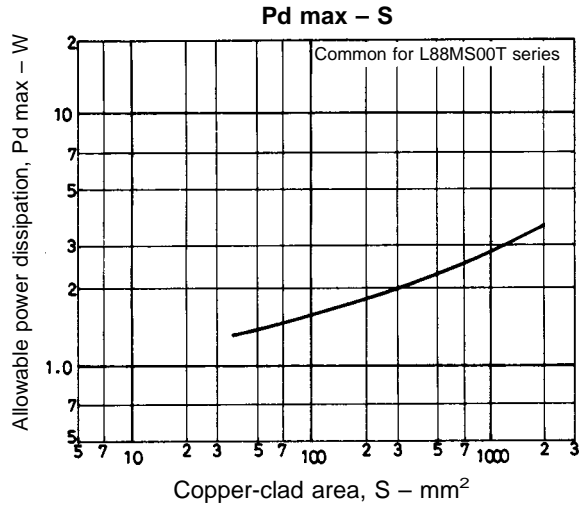

- * Pd is the value for when the solder on the surface of the IC heat sink has melted completely and the surface mount is horizontal.
- * Please be advised that the flow solder application system (full-heat method) cannot be recommended.

Lead Formings

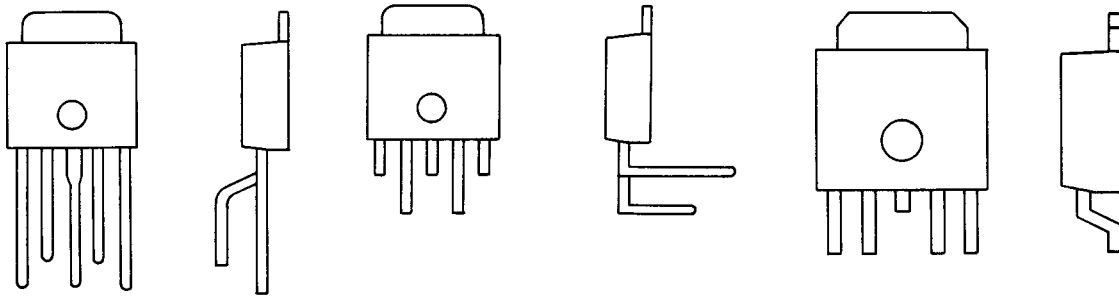

MA forming

LR forming

FA forming

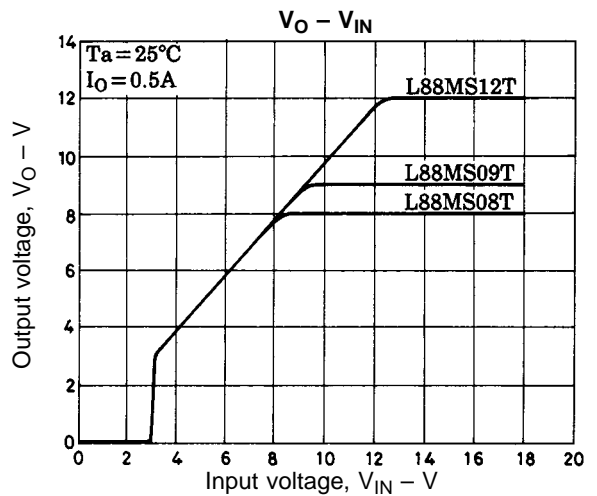
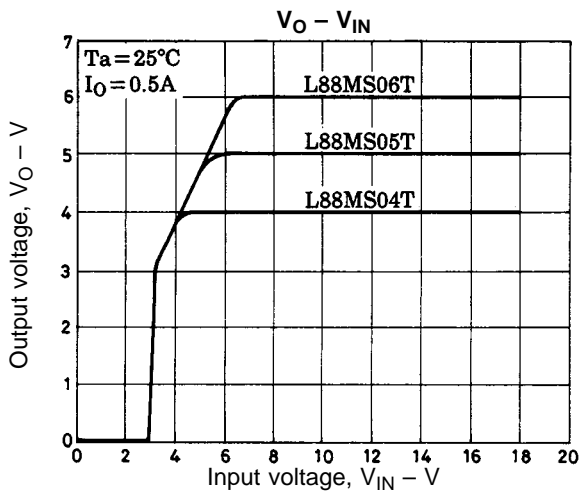

L88MS00T Series

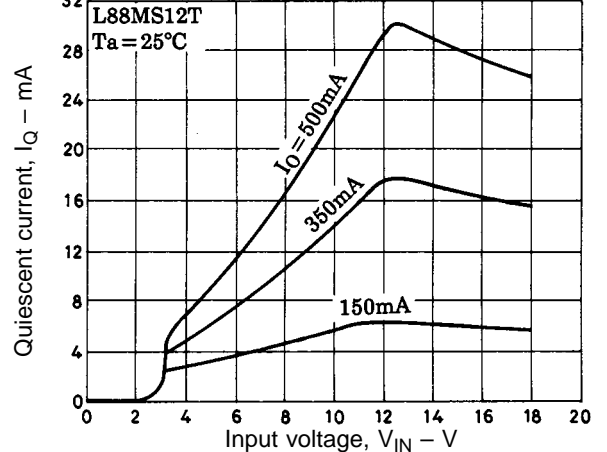
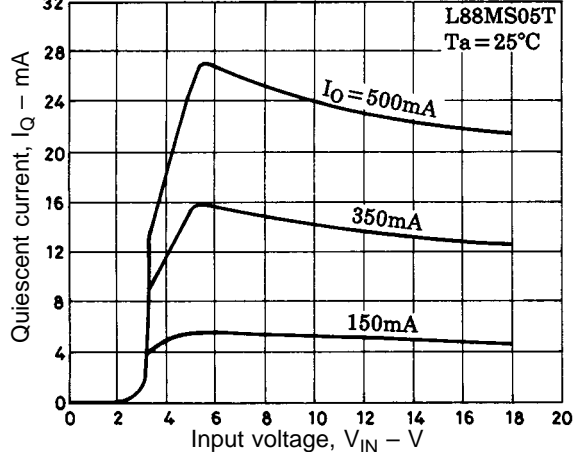
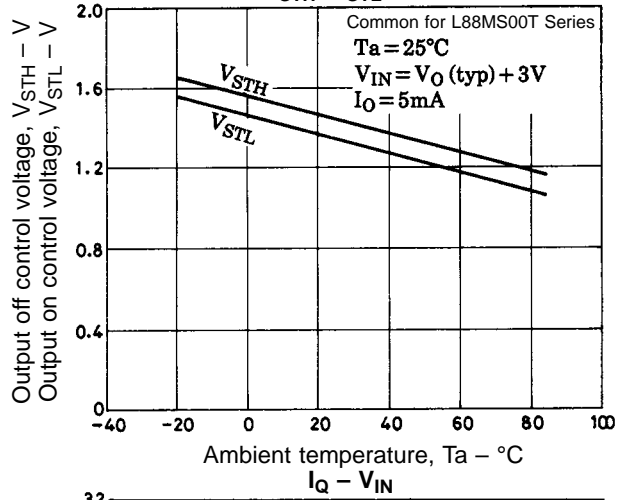
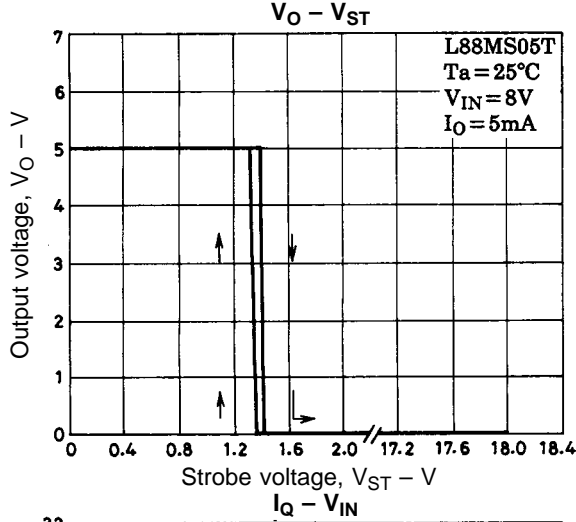
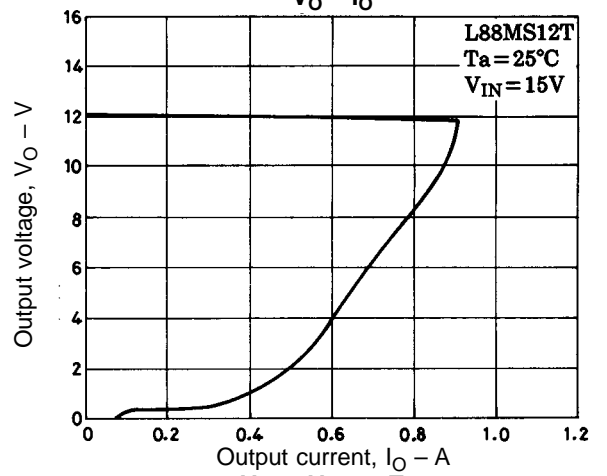
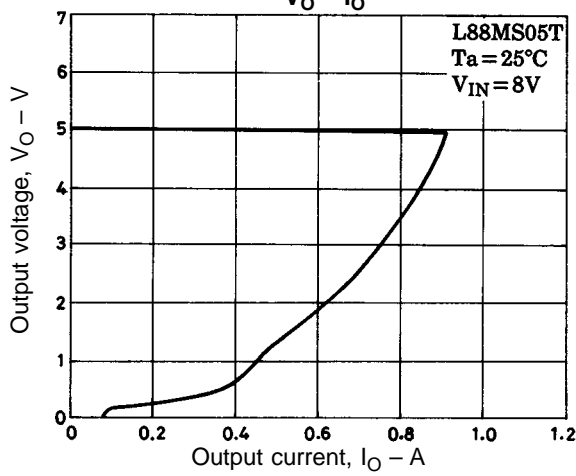
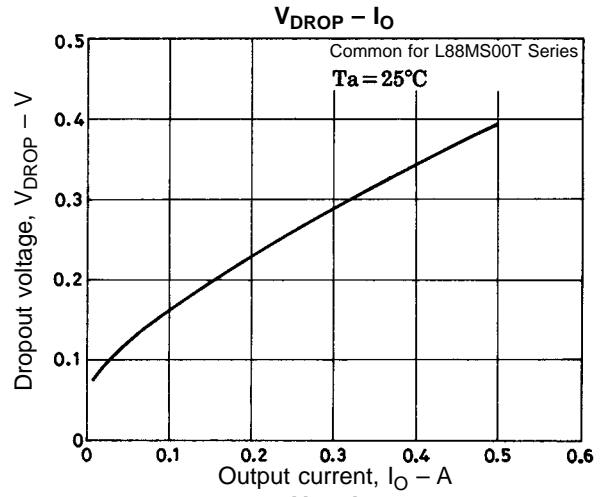
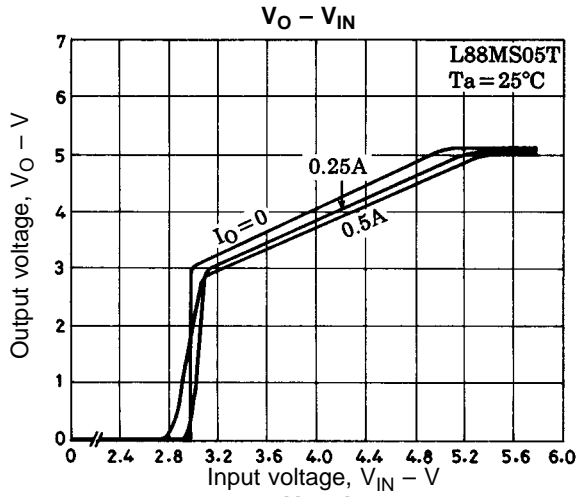

L88MS00T Series

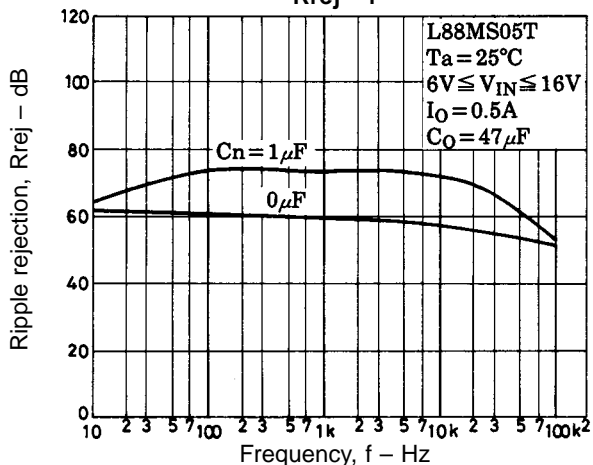
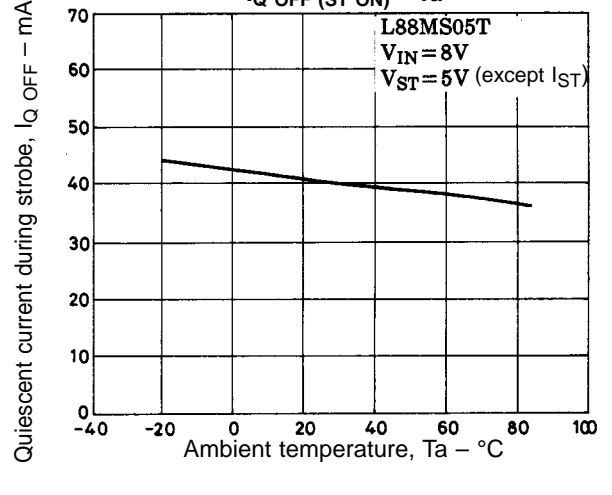
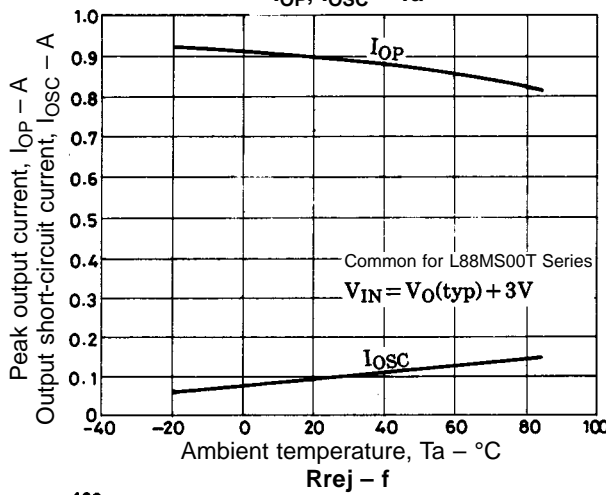
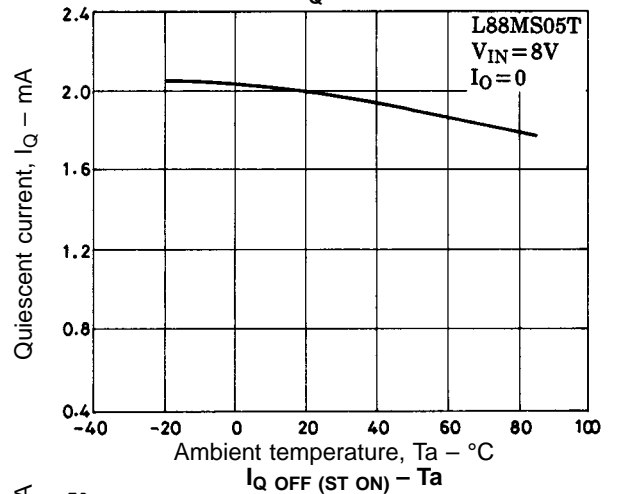
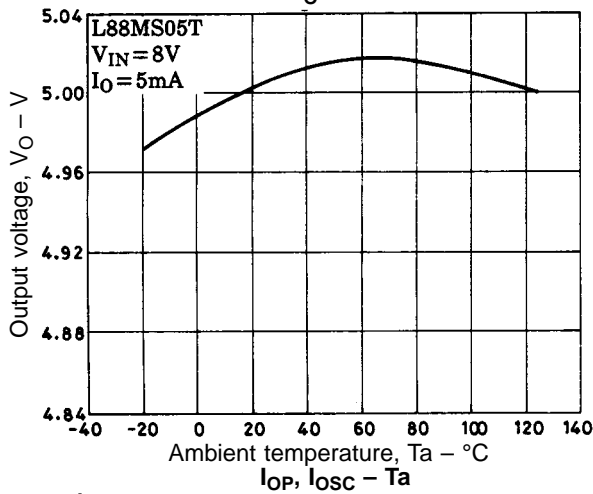
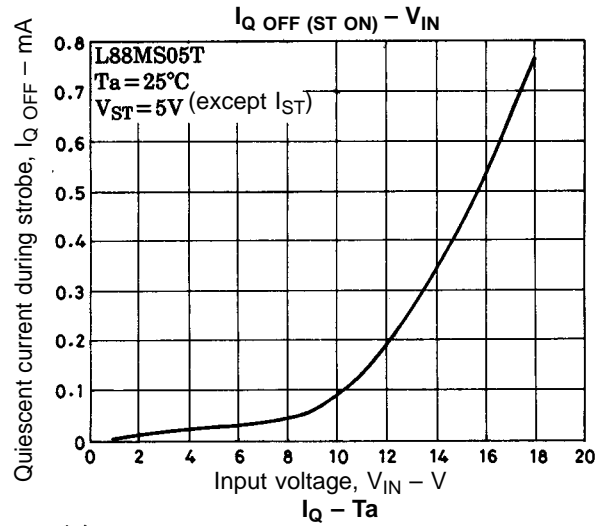
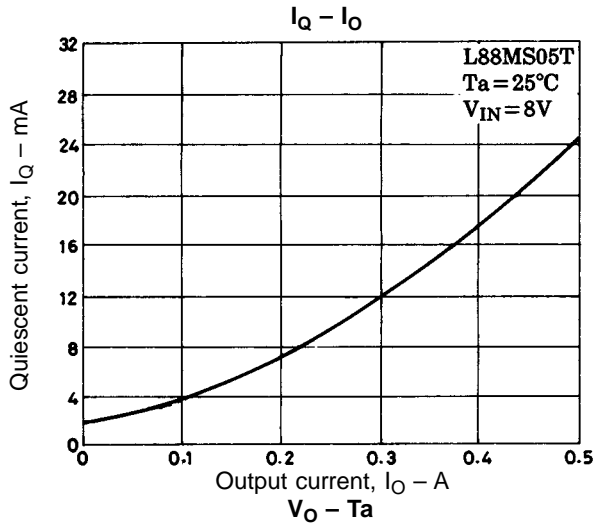

- No products described or contained herein are intended for use in surgical implants, life-support systems, aerospace equipment, nuclear power control systems, vehicles, disaster/crime-prevention equipment and the like, the failure of which may directly or indirectly cause injury, death or property loss.
- Anyone purchasing any products described or contained herein for an above-mentioned use shall:
 - ① Accept full responsibility and indemnify and defend SANYO ELECTRIC CO., LTD., its affiliates, subsidiaries and distributors and all their officers and employees, jointly and severally, against any and all claims and litigation and all damages, cost and expenses associated with such use:
 - ② Not impose any responsibility for any fault or negligence which may be cited in any such claim or litigation on SANYO ELECTRIC CO., LTD., its affiliates, subsidiaries and distributors or any of their officers and employees jointly or severally.
- Information (including circuit diagrams and circuit parameters) herein is for example only; it is not guaranteed for volume production. SANYO believes information herein is accurate and reliable, but no guarantees are made or implied regarding its use or any infringements of intellectual property rights or other rights of third parties.

This catalog provides information as of March, 1997. Specifications and information herein are subject to change without notice.