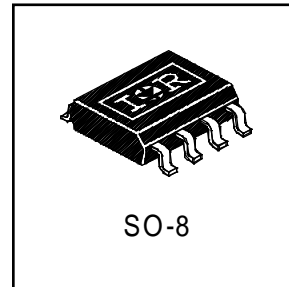
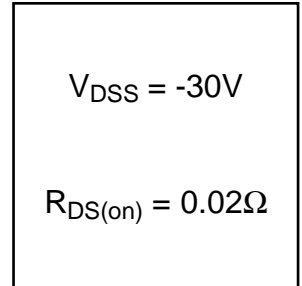
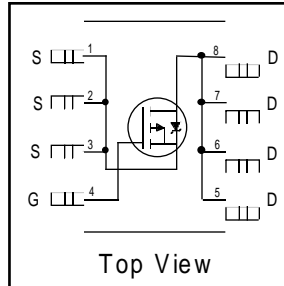


- Generation V Technology
- Ultra Low On-Resistance
- P-Channel Mosfet
- Surface Mount
- Available in Tape & Reel
- Dynamic dv/dt Rating
- Fast Switching

## Description

Fifth Generation HEXFETs from International Rectifier utilize advanced processing techniques to achieve extremely low on-resistance per silicon area. This benefit, combined with the fast switching speed and ruggedized device design that HEXFET Power MOSFETs are well known for, provides the designer with an extremely efficient and reliable device for use in a wide variety of applications.

The SO-8 has been modified through a customized leadframe for enhanced thermal characteristics and multiple-die capability making it ideal in a variety of power applications. With these improvements, multiple devices can be used in an application with dramatically reduced board space. The package is designed for vapor phase, infra red, or wave soldering techniques. Power dissipation of greater than 0.8W is possible in a typical PCB mount application.



## Absolute Maximum Ratings

|                          | Parameter                                 | Max.         | Units |
|--------------------------|---|--------------|-------|
| $I_D @ T_A = 25^\circ C$ | Continuous Drain Current, $V_{GS} @ -10V$ | -10          | A     |
| $I_D @ T_A = 70^\circ C$ | Continuous Drain Current, $V_{GS} @ -10V$ | -7.1         |       |
| $I_{DM}$                 | Pulsed Drain Current ①                    | -45          |       |
| $P_D @ T_A = 25^\circ C$ | Power Dissipation                         | 2.5          | W     |
|                          | Linear Derating Factor                    | 0.02         | mW/°C |
| $V_{GS}$                 | Gate-to-Source Voltage                    | $\pm 20$     | V     |
| $E_{AS}$                 | Single Pulse Avalanche Energy②            | 370          | mJ    |
| dv/dt                    | Peak Diode Recovery dv/dt ③               | -5.0         | V/ns  |
| $T_J, T_{STG}$           | Junction and Storage Temperature Range    | -55 to + 150 | °C    |

## Thermal Resistance Ratings

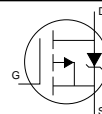
|                 | Parameter                    | Typ. | Max. | Units |
|-----------------|------------------------------|------|------|-------|
| $R_{\theta JA}$ | Maximum Junction-to-Ambient⑤ | —    | 50   | °C/W  |

## Electrical Characteristics @ $T_J = 25^\circ\text{C}$ (unless otherwise specified)

|                                 | Parameter                            | Min. | Typ.   | Max.  | Units               | Conditions  |
|---------------------------------|--------------------------------------|------|--------|-------|---------------------|---|
| $V_{(BR)DSS}$                   | Drain-to-Source Breakdown Voltage    | -30  | —      | —     | V                   | $V_{GS} = 0V, I_D = -250\mu A$                        |
| $\Delta V_{(BR)DSS}/\Delta T_J$ | Breakdown Voltage Temp. Coefficient  | —    | -0.024 | —     | V/ $^\circ\text{C}$ | Reference to $25^\circ\text{C}, I_D = -1\text{mA}$    |
| $R_{DS(on)}$                    | Static Drain-to-Source On-Resistance | —    | —      | 0.020 | $\Omega$            | $V_{GS} = -10V, I_D = -5.6A$ ④                        |
|                                 |                                      | —    | —      | 0.035 |                     | $V_{GS} = -4.5V, I_D = -2.8A$ ④                       |
| $V_{GS(th)}$                    | Gate Threshold Voltage               | -1.0 | —      | —     | V                   | $V_{DS} = V_{GS}, I_D = -250\mu A$                    |
| $g_{fs}$                        | Forward Transconductance             | 5.6  | —      | —     | S                   | $V_{DS} = -10V, I_D = -2.8A$                          |
| $I_{DSS}$                       | Drain-to-Source Leakage Current      | —    | —      | -1.0  | $\mu A$             | $V_{DS} = -24V, V_{GS} = 0V$                          |
|                                 |                                      | —    | —      | -25   |                     | $V_{DS} = -24V, V_{GS} = 0V, T_J = 125^\circ\text{C}$ |
| $I_{GSS}$                       | Gate-to-Source Forward Leakage       | —    | —      | -100  | nA                  | $V_{GS} = -20V$                                       |
|                                 | Gate-to-Source Reverse Leakage       | —    | —      | 100   |                     | $V_{GS} = 20V$  |
| $Q_g$                           | Total Gate Charge                    | —    | 61     | 92    | nC                  | $I_D = -5.6A$   |
| $Q_{gs}$                        | Gate-to-Source Charge                | —    | 8.0    | 12    |                     | $V_{DS} = -24V$                                       |
| $Q_{gd}$                        | Gate-to-Drain ("Miller") Charge      | —    | 22     | 32    |                     | $V_{GS} = -10V$ , See Fig. 6 and 9 ④                  |
| $t_{d(on)}$                     | Turn-On Delay Time                   | —    | 18     | —     | ns                  | $V_{DD} = -15V$                                       |
| $t_r$                           | Rise Time                            | —    | 49     | —     |                     | $I_D = -5.6A$   |
| $t_{d(off)}$                    | Turn-Off Delay Time                  | —    | 59     | —     |                     | $R_G = 6.2\Omega$                                     |
| $t_f$                           | Fall Time                            | —    | 60     | —     |                     | $R_D = 2.7\Omega$ , See Fig. 10 ④                     |
| $C_{iss}$                       | Input Capacitance                    | —    | 1700   | —     | pF                  | $V_{GS} = 0V$   |
| $C_{oss}$                       | Output Capacitance                   | —    | 890    | —     |                     | $V_{DS} = -25V$                                       |
| $C_{rss}$                       | Reverse Transfer Capacitance         | —    | 410    | —     |                     | $f = 1.0\text{MHz}$ , See Fig. 5                      |

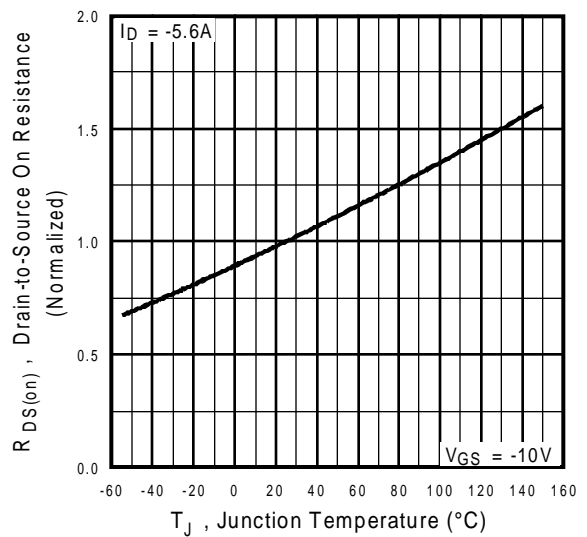
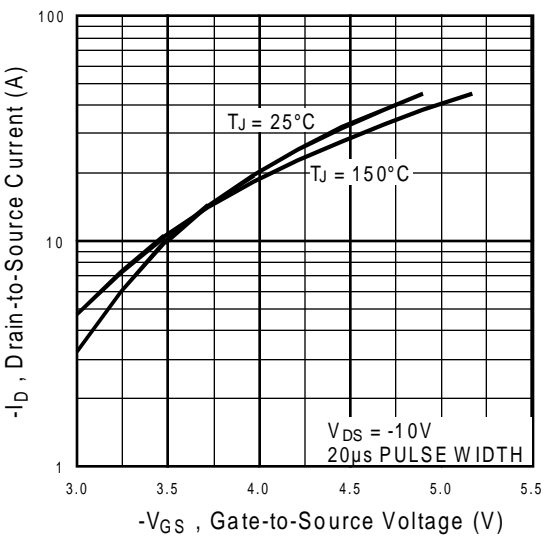
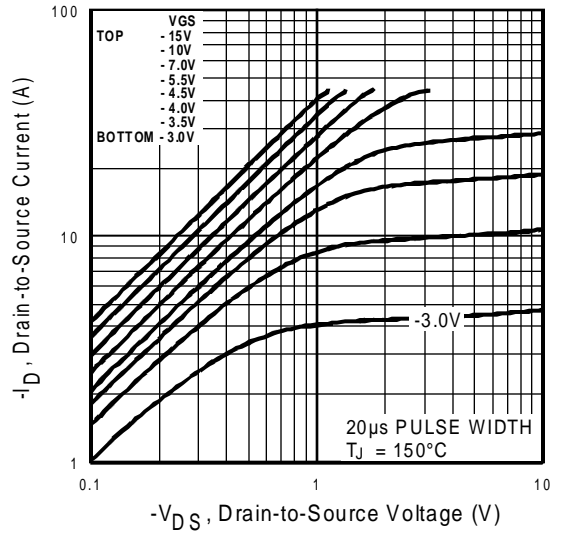
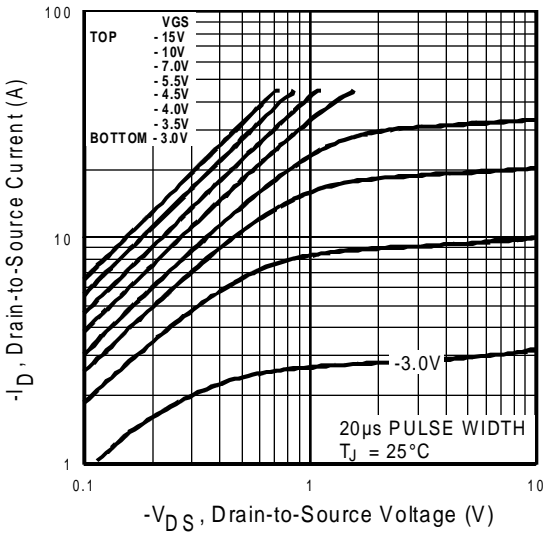
## Source-Drain Ratings and Characteristics

|          | Parameter                                 | Min. | Typ. | Max. | Units | Conditions  |
|----------|---|------|------|------|-------|---|
| $I_S$    | Continuous Source Current<br>(Body Diode) | —    | —    | -3.1 | A     | MOSFET symbol<br>showing the<br>integral reverse<br>p-n junction diode. |
| $I_{SM}$ | Pulsed Source Current<br>(Body Diode) ①   | —    | —    | -45  |       |   |
| $V_{SD}$ | Diode Forward Voltage                     | —    | —    | -1.0 | V     | $T_J = 25^\circ\text{C}, I_S = -5.6A, V_{GS} = 0V$ ③                    |
| $t_{rr}$ | Reverse Recovery Time                     | —    | 56   | 85   | ns    | $T_J = 25^\circ\text{C}, I_F = -5.6A$                                   |
| $Q_{rr}$ | Reverse Recovery Charge                   | —    | 99   | 150  | nC    | $di/dt = 100A/\mu s$ ③  |



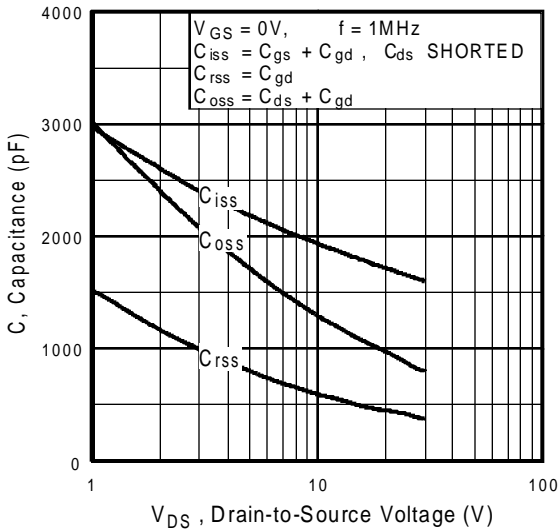
### Notes:

- ① Repetitive rating; pulse width limited by max. junction temperature. ( See fig. 11 )
- ② Starting  $T_J = 25^\circ\text{C}$ ,  $L = 25\text{mH}$   
 $R_G = 25\Omega, I_{AS} = -5.6A$ . (See Figure 12)
- ③  $I_{SD} \leq -5.6A, di/dt \leq 100A/\mu s, V_{DD} \leq V_{(BR)DSS}, T_J \leq 150^\circ\text{C}$
- ④ Pulse width  $\leq 300\mu s$ ; duty cycle  $\leq 2\%$ .
- ⑤ Surface mounted on FR-4 board,  $t \leq 10\text{sec}$ .

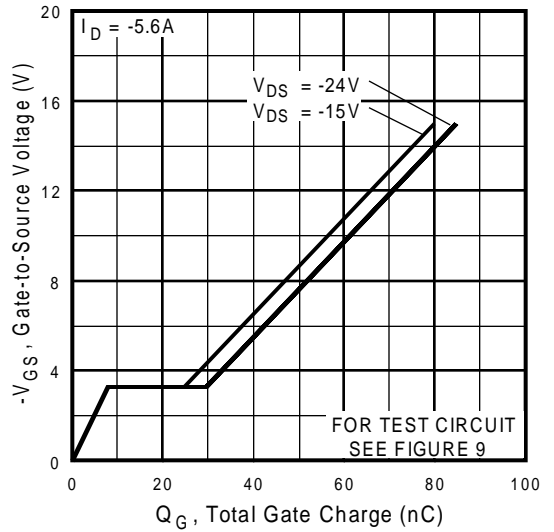


**Fig 3.** Typical Transfer Characteristics

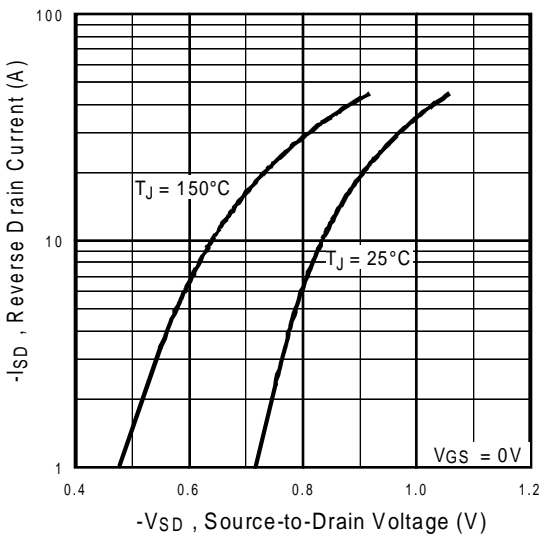
**Fig 4.** Normalized On-Resistance Vs. Temperature



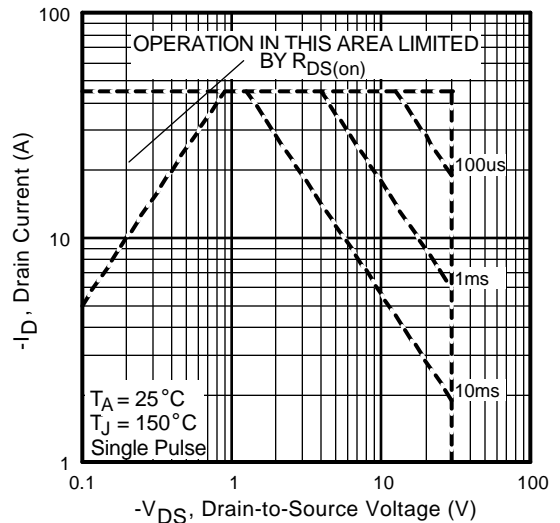
**Fig 5.** Typical Capacitance Vs. Drain-to-Source Voltage



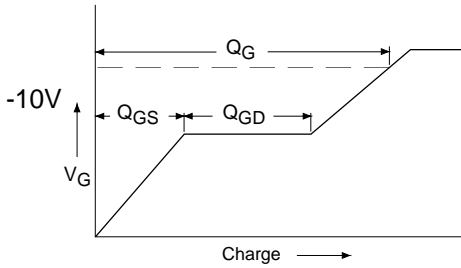
**Fig 6.** Typical Gate Charge Vs. Gate-to-Source Voltage



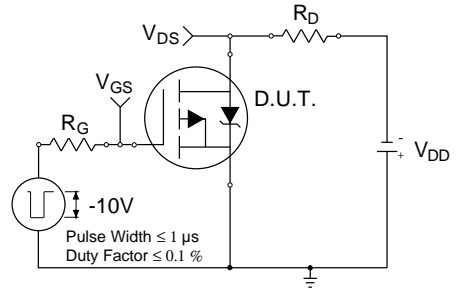
**Fig 7.** Typical Source-Drain Diode Forward Voltage



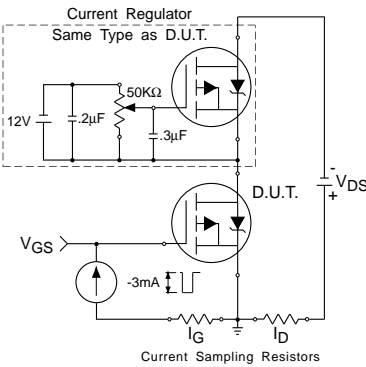
**Fig 8.** Maximum Safe Operating Area



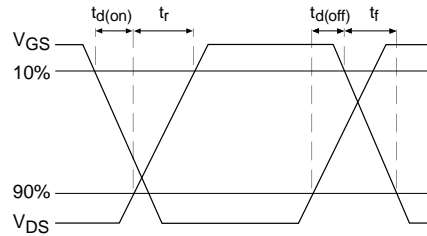
**Fig 9a.** Basic Gate Charge Waveform



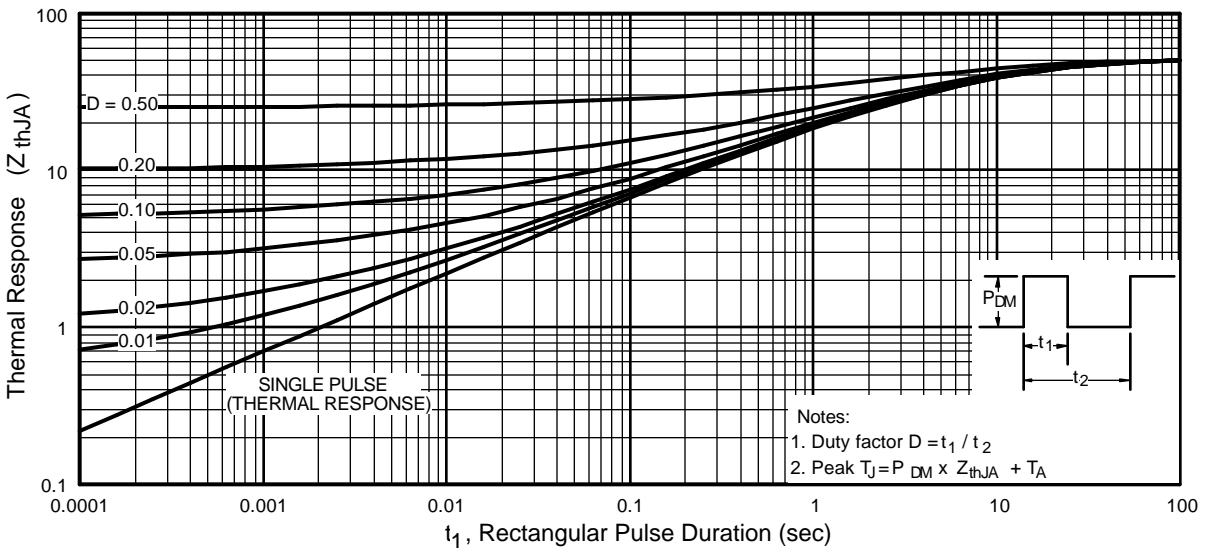
**Fig 10a.** Switching Time Test Circuit



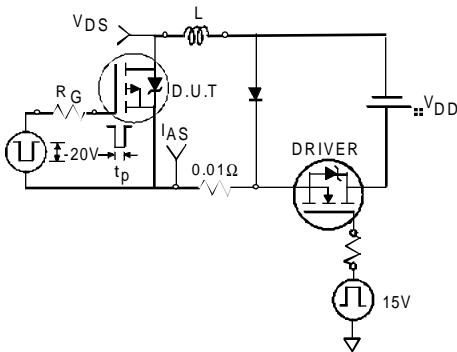
**Fig 9b.** Gate Charge Test Circuit



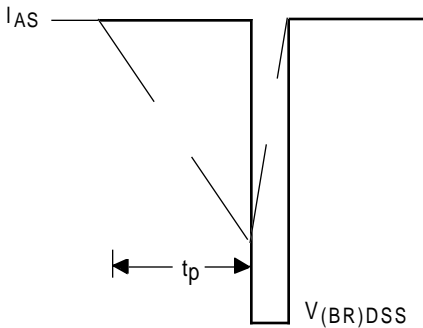
**Fig 10b.** Switching Time Waveforms



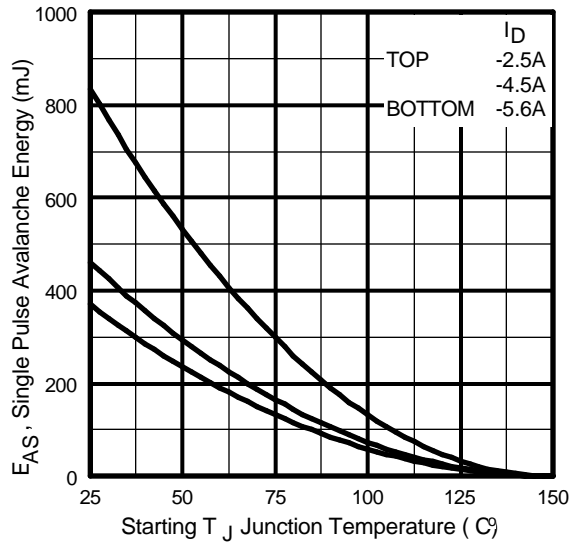
**Fig 11.** Maximum Effective Transient Thermal Impedance, Junction-to-Ambient



**Fig 12a.** Unclamped Inductive Test Circuit

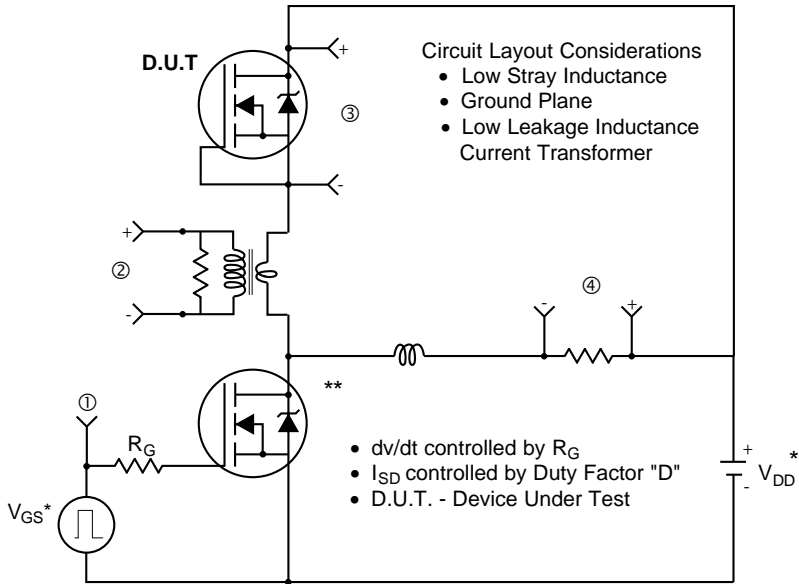


**Fig 12b.** Unclamped Inductive Waveforms



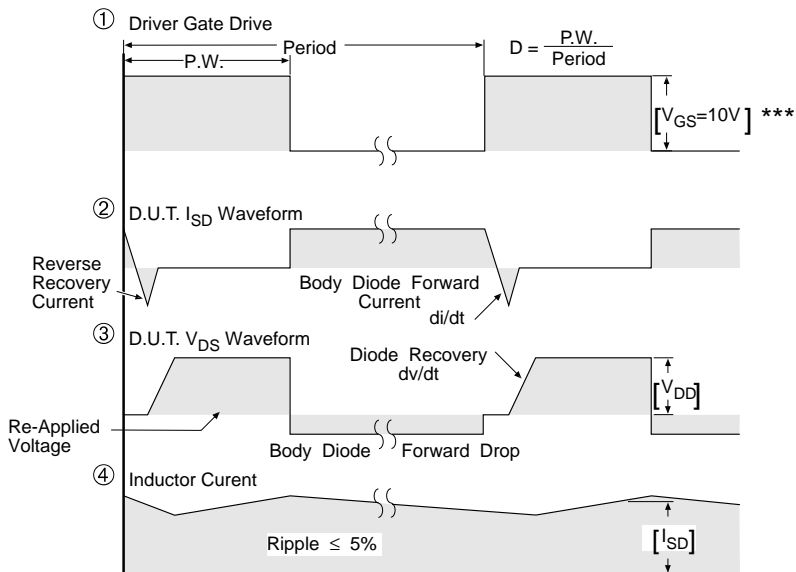
**Fig 12c.** Maximum Avalanche Energy Vs. Drain Current

### Peak Diode Recovery dv/dt Test Circuit



\* Reverse Polarity for P-Channel

\*\* Use P-Channel Driver for P-Channel Measurements



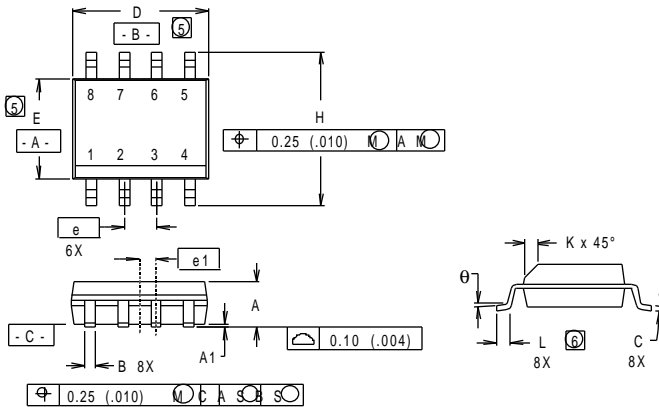
\*\*\*  $V_{GS} = 5.0V$  for Logic Level and 3V Drive Devices

**Fig 13. For P-Channel HEXFETS**

# IRF7416

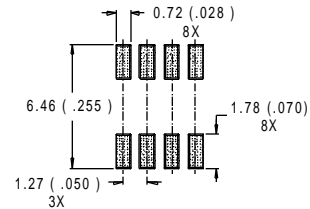
## Package Outline

### SO8 Outline



| DIM | INCHES     |       | MILLIMETERS |      |
|-----|------------|-------|-------------|------|
|     | MIN        | MAX   | MIN         | MAX  |
| A   | .0532      | .0688 | 1.35        | 1.75 |
| A1  | .0040      | .0098 | 0.10        | 0.25 |
| B   | .014       | .018  | 0.36        | 0.46 |
| C   | .0075      | .0098 | 0.19        | 0.25 |
| D   | .189       | .196  | 4.80        | 4.98 |
| E   | .150       | .157  | 3.81        | 3.99 |
| e   | .050 BASIC |       | 1.27 BASIC  |      |
| e1  | .025 BASIC |       | 0.635 BASIC |      |
| H   | .2284      | .2440 | 5.80        | 6.20 |
| K   | .011       | .019  | 0.28        | 0.48 |
| L   | 0.16       | .050  | 0.41        | 1.27 |
| θ   | 0°         | 8°    | 0°          | 8°   |

#### RECOMMENDED FOOTPRINT



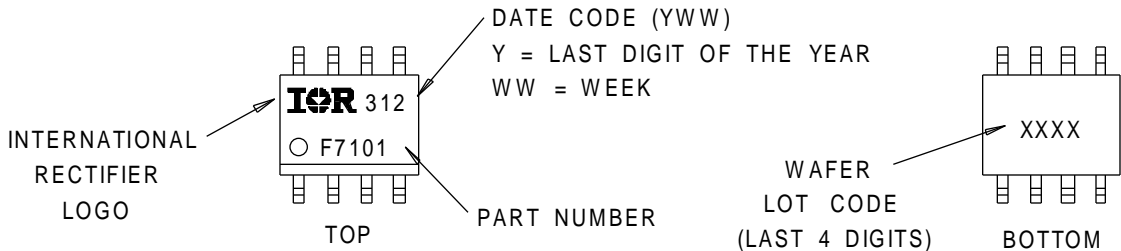
#### NOTES:

1. DIMENSIONING AND TOLERANCING PER ANSI Y14.5M-1982.
2. CONTROLLING DIMENSION : INCH.
3. DIMENSIONS ARE SHOWN IN MILLIMETERS (INCHES).
4. OUTLINE CONFORMS TO JEDEC OUTLINE MS-012AA.
- ⑤ DIMENSION DOES NOT INCLUDE MOLD PROTRUSIONS  
MOLD PROTRUSIONS NOT TO EXCEED 0.25 (.006).
- ⑥ DIMENSIONS IS THE LENGTH OF LEAD FOR SOLDERING TO A SUBSTRATE..

## Part Marking Information

### SO8

EXAMPLE : THIS IS AN IRF7101

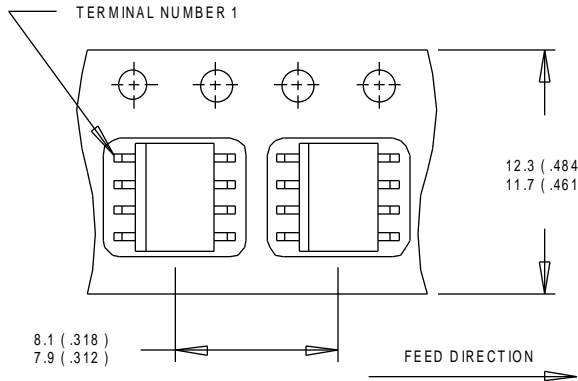




**Tape & Reel Information**

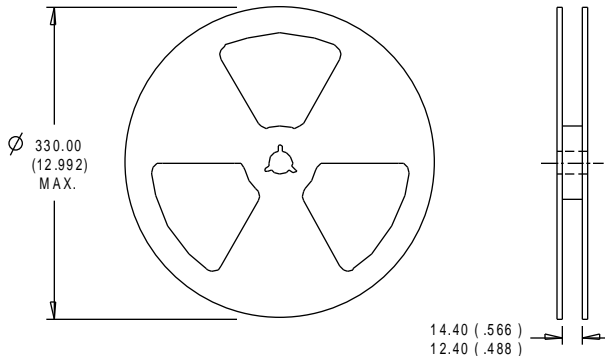
**S08**

Dimensions are shown in millimeters (inches)



**NOTES:**

1. CONTROLLING DIMENSION : MILLIMETER.
2. ALL DIMENSIONS ARE SHOWN IN MILLIMETERS(INCHES).
3. OUTLINE CONFORMS TO EIA-481 & EIA-541.



**NOTES :**

1. CONTROLLING DIMENSION : MILLIMETER.
2. OUTLINE CONFORMS TO EIA-481 & EIA-541.