

74LCX16646

Low Voltage 16-Bit Transceiver/Register with 5V Tolerant Inputs and Outputs

General Description

The LCX16646 contains sixteen non-inverting bidirectional registered bus transceivers with 3-STATE outputs, providing multiplexed transmission of data directly from the input bus or from the internal storage registers. Each byte has separate control inputs which can be shorted together for full 16-bit operation. The DIR inputs determine the direction of data flow through the device. The CPAB and CPBA inputs load data into the registers on the LOW-to-HIGH transition (see Functional Description).

The LCX16646 is designed for low voltage (2.5V or 3.3V) V_{CC} applications with capability of interfacing to a 5V signal environment.

The LCX16646 is fabricated with an advanced CMOS technology to achieve high speed operation while maintaining CMOS low power dissipation.

Features

- 5V tolerant inputs and outputs
- 2.3V–3.6V V_{CC} specifications provided
- 5.2 ns t_{PD} max ($V_{CC} = 3.3V$), 20 μA I_{CC} max
- Power down high impedance inputs and outputs
- Supports live insertion/withdrawal (Note 1)
- ± 24 mA Output Drive ($V_{CC} = 3.0V$)
- Implements patented noise/EMI reduction circuitry
- Latch-up performance exceeds 500 mA
- ESD performance:
 - Human Body Model > 2000V
 - Machine Model > 200V

Note 1: To ensure the high-impedance state during power up or down, \overline{OE} should be tied to V_{CC} through a pull-up resistor; the minimum value or the resistor is determined by the current-sourcing capability of the driver.

Ordering Code:

Order Number	Package Number	Package Description
74LCX16646MEA	MS56A	56-Lead Shrink Small Outline Package (SSOP), JEDEC MO-118, 0.300" Wide
74LCX16646MTD	MTD56	56-Lead Thin Shrink Small Outline Package (TSSOP), JEDEC MO-153, 6.1mm Wide

Devices also available in Tape and Reel. Specify by appending suffix letter "X" to the ordering code.

Logic Symbol

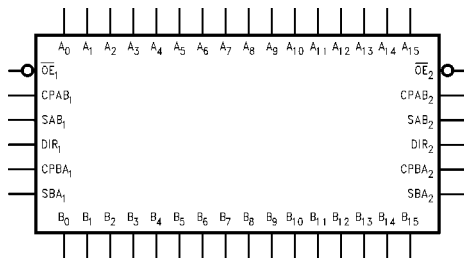

Pin Descriptions

Pin Names	Description
A_n	Side A Inputs or 3-STATE Outputs
B_n	Side B Inputs or 3-STATE Outputs
\overline{OE}_n	Output Enable Inputs
$CPAB_n, CPBA_n$	Clock Pulse Inputs
SAB_n, SBA_n	Select Inputs
DIR_n	Direction Control Inputs

Connection Diagram

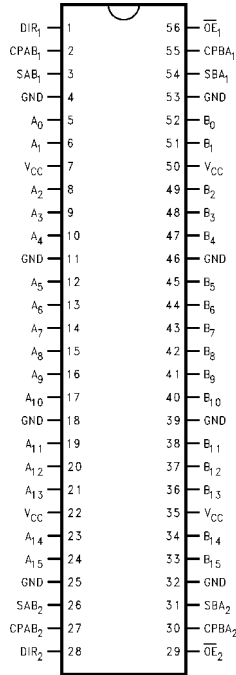

Truth Table

(Note 2)

Inputs						Data I/O		Output Operation Mode
\overline{OE}_1	DIR ₁	CPAB ₁	CPBA ₁	SAB ₁	SBA ₁	A ₀₋₇	B ₀₋₇	
H	X	H or L	H or L	X	X			Isolation
H	X	↗	X	X	X	Input	Input	Clock A _n Data into A Register Clock B _n Data Into B Register
H	X	X	↗	X	X			
L	H	X	X	L	X			A _n to B _n —Real Time (Transparent Mode)
L	H	↗	X	L	X	Input	Output	Clock A _n Data to A Register
L	H	H or L	X	H	X			A Register to B _n (Stored Mode)
L	H	↗	X	H	X			Clock A _n Data into A Register and Output to B _n
L	L	X	X	X	L			B _n to A _n —Real Time (Transparent Mode)
L	L	X	↗	X	L	Output	Input	Clock B _n Data into B Register
L	L	X	H or L	X	H			B Register to A _n (Stored Mode)
L	L	X	↗	X	H			Clock B _n into B Register and Output to A _n

H = HIGH Voltage Level X = Immaterial
L = LOW Voltage Level ↗ = LOW-to-HIGH Transition.

Note 2: The data output functions may be enabled or disabled by various signals at the \overline{OE} and DIR inputs. Data input functions are always enabled; i.e., data at the bus pins will be stored on every LOW-to-HIGH transition of the appropriate clock inputs. Also applies to data I/O (A and B: 8-15) and #2 control pins.

Logic Diagrams

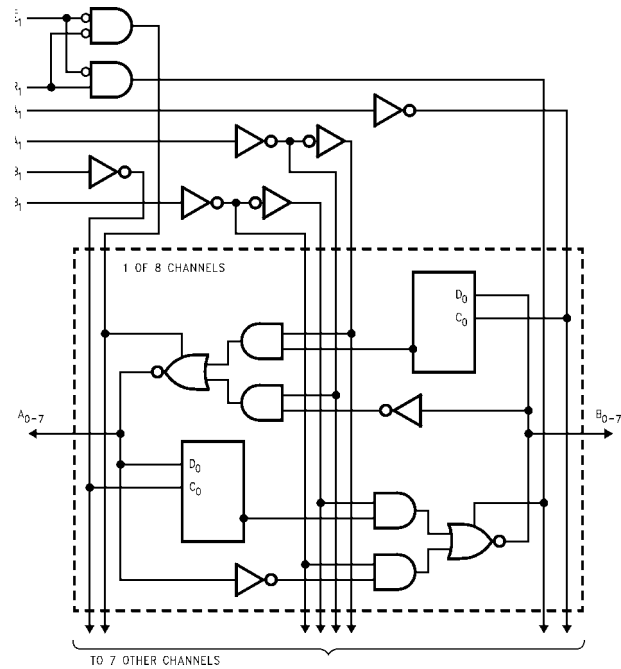
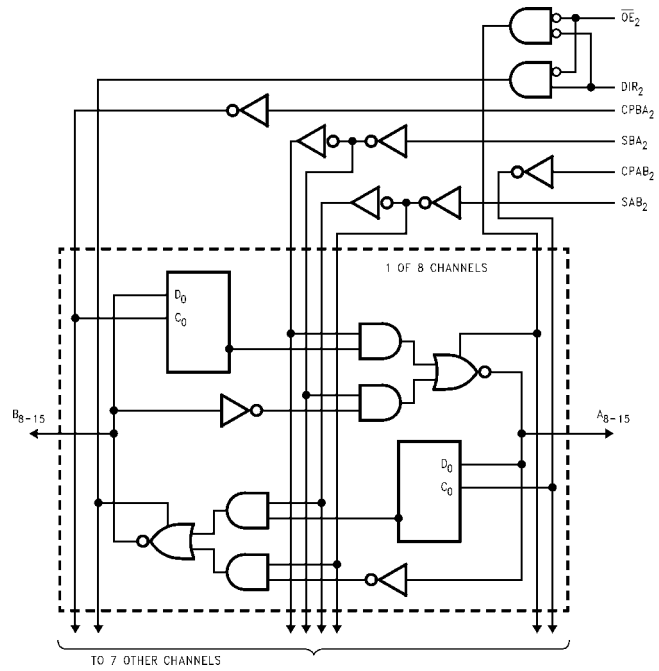

Please note that these diagrams are provided only for the understanding of logic operations and should not be used to estimate propagation delays.

Functional Description

In the transceiver mode, data present at the HIGH impedance port may be stored in either the A or B register or both. The select (SAB_n , SBA_n) controls can multiplex stored and real-time. The examples shown below demonstrate the four fundamental bus-management functions that can be performed.

The direction control (DIR_n) determines which bus will receive data when \overline{OE}_n is LOW. In the isolation mode (\overline{OE}_n HIGH), A data may be stored in one register and/or B data may be stored in the other register. When an output function is disabled, the input function is still enabled and may be used to store and transmit data. Only one of the two busses, A or B, may be driven at a time.

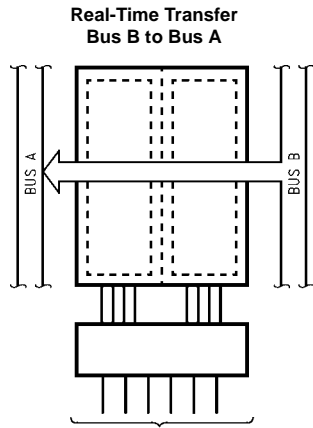

**Real-Time Transfer
Bus B to Bus A**

\overline{OE}	DIR	CPAB	CPBA	SAB	SBA
L	L	X	X	X	L

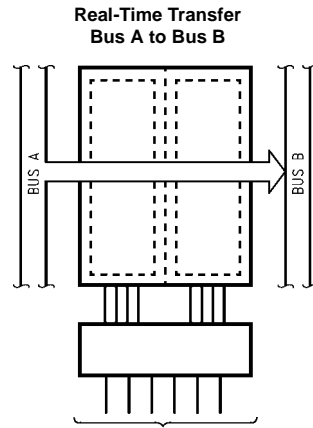

**Real-Time Transfer
Bus A to Bus B**

\overline{OE}	DIR	CPAB	CPBA	SAB	SBA
L	H	X	X	L	X

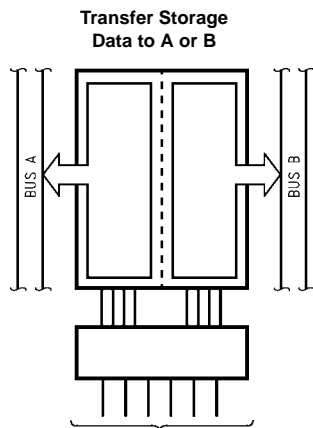

**Transfer Storage
Data to A or B**

\overline{OE}	DIR	CPAB	CPBA	SAB	SBA
L	L	X	HorL	X	H
L	H	HorL	X	H	X

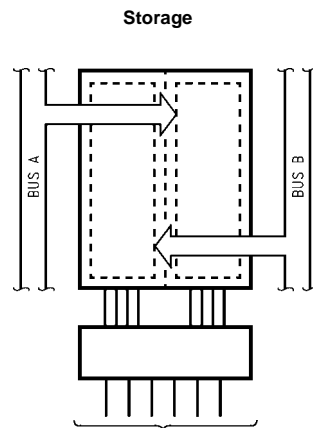

Storage

\overline{OE}	DIR	CPAB	CPBA	SAB	SBA
L	H	↗	X	L	X
L	X	X	↗	X	L
H	X	↗	X	X	X
H	X	X	↗	X	X

Absolute Maximum Ratings (Note 3)						
Symbol	Parameter	Value	Conditions	Units		
V_{CC}	Supply Voltage	-0.5 to +7.0		V		
V_I	DC Input Voltage	-0.5 to +7.0		V		
V_O	DC Output Voltage	-0.5 to +7.0 -0.5 to $V_{CC} + 0.5$	Output in 3-STATE Output in HIGH or LOW State (Note 4)	V		
I_{IK}	DC Input Diode Current	-50	$V_I < GND$	mA		
I_{OK}	DC Output Diode Current	-50 +50	$V_O < GND$ $V_O > V_{CC}$	mA		
I_O	DC Output Source/Sink Current	± 50		mA		
I_{CC}	DC Supply Current per Supply Pin	± 100		mA		
I_{GND}	DC Ground Current per Ground Pin	± 100		mA		
T_{STG}	Storage Temperature	-65 to +150		°C		
Recommended Operating Conditions (Note 5)						
Symbol	Parameter	Min	Max	Units		
V_{CC}	Supply Voltage	Operating	2.0	3.6	V	
		Data Retention	1.5	3.6		
V_I	Input Voltage	0	5.5	V		
V_O	Output Voltage	HIGH or LOW State	0	V_{CC}	V	
		3-STATE	0	5.5		
I_{OH}/I_{OL}	Output Current	$V_{CC} = 3.0V - 3.6V$		± 24	mA	
		$V_{CC} = 2.7V - 3.0V$		± 12		
		$V_{CC} = 2.3V - 2.7V$		± 8		
T_A	Free-Air Operating Temperature	-40	85	°C		
$\Delta t/\Delta V$	Input Edge Rate, $V_{IN} = 0.8V - 2.0V$, $V_{CC} = 3.0V$	0	10	ns/V		
<p>Note 3: The Absolute Maximum Ratings are those values beyond which the safety of the device cannot be guaranteed. The device should not be operated at these limits. The parametric values defined in the Electrical Characteristics tables are not guaranteed at the Absolute Maximum Ratings. The "Recommended Operating Conditions" table will define the conditions for actual device operation.</p> <p>Note 4: I_O Absolute Maximum Rating must be observed.</p> <p>Note 5: Unused inputs and I/Os must be held HIGH or LOW. They may not float.</p>						
DC Electrical Characteristics						
Symbol	Parameter	Conditions	V_{CC} (V)	$T_A = -40^\circ C \text{ to } +85^\circ C$		Units
				Min	Max	
V_{IH}	HIGH Level Input Voltage		2.3 - 2.7	1.7		V
			2.7 - 3.6	2.0		
V_{IL}	LOW Level Input Voltage		2.3 - 2.7		0.7	V
			2.7 - 3.6		0.8	
V_{OH}	HIGH Level Output Voltage	$I_{OH} = -100 \mu A$	2.3 - 3.6	$V_{CC} - 0.2$		V
		$I_{OH} = -8 \text{ mA}$	2.3	1.8		
		$I_{OH} = -12 \text{ mA}$	2.7	2.2		
		$I_{OH} = -18 \text{ mA}$	3.0	2.4		
		$I_{OH} = -24 \text{ mA}$	3.0	2.2		
V_{OL}	LOW Level Output Voltage	$I_{OL} = 100 \mu A$	2.3 - 3.6		0.2	V
		$I_{OL} = 8 \text{ mA}$	2.3		0.6	
		$I_{OL} = 12 \text{ mA}$	2.7		0.4	
		$I_{OL} = 16 \text{ mA}$	3.0		0.4	
		$I_{OL} = 24 \text{ mA}$	3.0		0.55	
I_I	Input Leakage Current	$0 \leq V_I \leq 5.5V$	2.3 - 3.6		± 5.0	μA
I_{OZ}	3-STATE I/O Leakage	$0 \leq V_O \leq 5.5V$ $V_I = V_{IH} \text{ or } V_{IL}$	2.3 - 3.6		± 5.0	μA
I_{OFF}	Power-Off Leakage Current	$V_I \text{ or } V_O = 5.5V$	0		10	μA

DC Electrical Characteristics (Continued)								
Symbol	Parameter	Conditions	V _{CC} (V)	T _A = -40°C to +85°C		Units		
				Min	Max			
I _{CC}	Quiescent Supply Current	V _I = V _{CC} or GND	2.3 – 3.6		20	μA		
		3.6V ≤ V _I , V _O ≤ 5.5V (Note 6)	2.3 – 3.6		±20			
ΔI _{CC}	Increase in I _{CC} per Input	V _{IH} = V _{CC} - 0.6V	2.3 – 3.6		500	μA		
Note 6: Outputs disabled or 3-STATE only.								
AC Electrical Characteristics								
Symbol	Parameter	T _A = -40°C to +85°C, R _L = 500Ω						Units
		V _{CC} = 3.3V ± 0.3V		V _{CC} = 2.7V		V _{CC} = 2.5V ± 0.2V		
		C _L = 50 pF		C _L = 50 pF		C _L = 30 pF		
		Min	Max	Min	Max	Min	Max	
f _{MAX}	Maximum Clock Frequency	170						ns
t _{PHL}	Propagation Delay	1.5	5.2	1.5	6.0	1.5	6.2	ns
t _{PLH}	Bus to Bus	1.5	5.2	1.5	6.0	1.5	6.2	
t _{PHL}	Propagation Delay	1.5	6.0	1.5	7.0	1.5	7.2	ns
t _{PLH}	Clock to Bus	1.5	6.0	1.5	7.0	1.5	7.2	
t _{PHL}	Propagation Delay	1.5	6.0	1.5	7.0	1.5	7.2	ns
t _{PLH}	Select to Bus	1.5	6.0	1.5	7.0	1.5	7.2	
t _{PZL}	Output Enable Time	1.5	7.5	1.5	8.5	1.5	9.8	ns
t _{PZH}	Output Disable Time	1.5	7.5	1.5	8.5	1.5	9.8	
t _{PLZ}	Output Disable Time	1.5	6.5	1.5	7.5	1.5	7.8	ns
t _{PHZ}	Output Disable Time	1.5	6.5	1.5	7.5	1.5	7.8	
t _S	Setup Time	2.5		2.5		3.0		ns
t _H	Hold Time	1.5		1.5		2.0		ns
t _W	Pulse Width	3.0		3.0		3.5		ns
t _{OSHL}	Output to Output Skew (Note 7)		1.0					ns
t _{OSLH}			1.0					
Note 7: Skew is defined as the absolute value of the difference between the actual propagation delay for any two separate outputs of the same device. The specification applies to any outputs switching in the same direction, either HIGH-to-LOW (t _{OSHL}) or LOW-to-HIGH (t _{OSLH}). Parameter guaranteed by design.								
Dynamic Switching Characteristics								
Symbol	Parameter	Conditions	V _{CC} (V)	T _A = 25°C		Units		
				Typical				
V _{OLP}	Quiet Output Dynamic Peak V _{OL}	C _L = 50 pF, V _{IH} = 3.3V, V _{IL} = 0V	3.3	0.8		V		
		C _L = 30 pF, V _{IH} = 2.5V, V _{IL} = 0V	2.5	0.6				
V _{OLV}	Quiet Output Dynamic Valley V _{OL}	C _L = 50 pF, V _{IH} = 3.3V, V _{IL} = 0V	3.3	-0.8		V		
		C _L = 30 pF, V _{IH} = 2.5V, V _{IL} = 0V	2.5	-0.6				
Capacitance								
Symbol	Parameter	Conditions	Typical	Units				
C _{IN}	Input Capacitance	V _{CC} = Open, V _I = 0V or V _{CC}	7	pF				
C _{IO}	Input/Output Capacitance	V _{CC} = 3.3V, V _I = 0V or V _{CC}	8	pF				
C _{PD}	Power Dissipation Capacitance	V _{CC} = 3.3V, V _I = 0V or V _{CC} , F = 10 MHz	20	pF				

AC LOADING and WAVEFORMS Generic for LCX Family

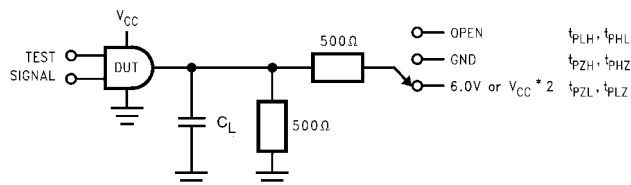
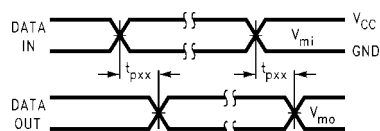
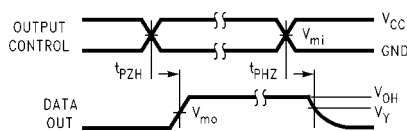

FIGURE 1. AC Test Circuit (C_L includes probe and jig capacitance)

Test	Switch
t_{PLH}, t_{PHL}	Open
t_{PZL}, t_{PLZ}	6V at $V_{CC} = 3.3 \pm 0.3V$ $V_{CC} \times 2$ at $V_{CC} = 2.5 \pm 0.2V$
t_{PZH}, t_{PHZ}	GND



Waveform for Inverting and Non-Inverting Functions



3-STATE Output High Enable and Disable Times for Logic

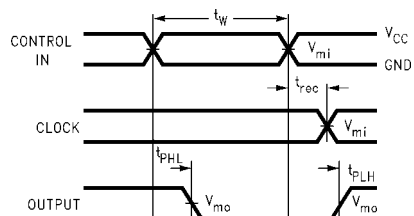

Propagation Delay, Pulse Width and t_{rec} Waveforms

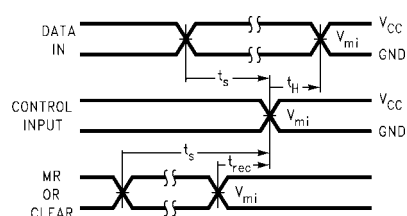

Setup Time, Hold Time and Recovery Time for Logic

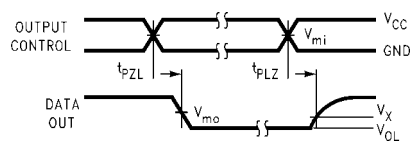

3-STATE Output Low Enable and Disable Times for Logic

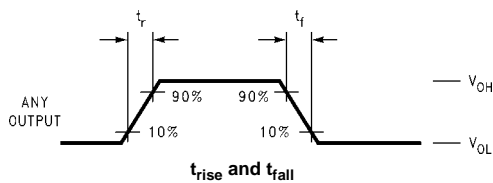
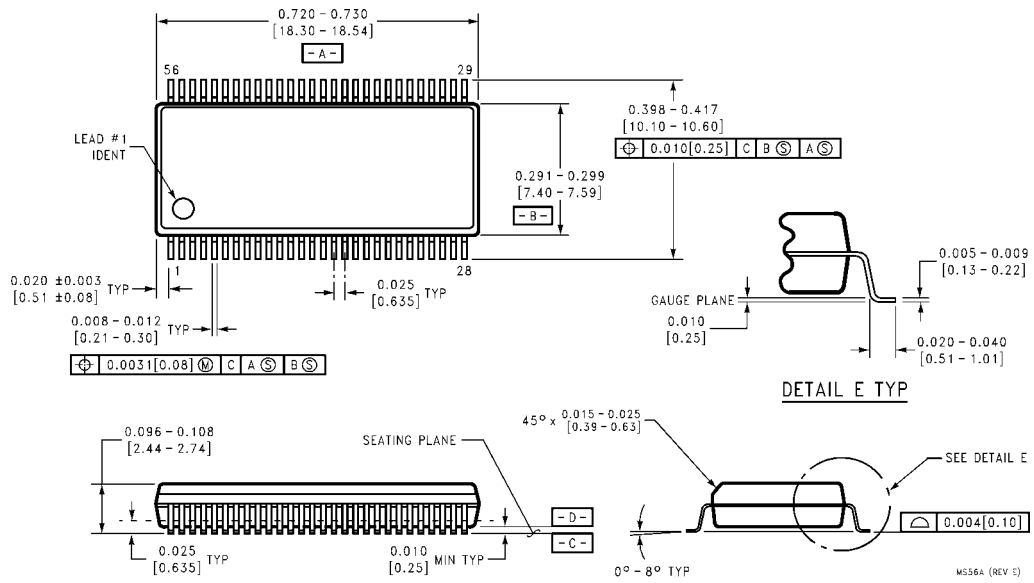

FIGURE 2. Waveforms
(Input Characteristics; $f = 1MHz, t_R = t_F = 3ns$)

Symbol	V_{CC}		
	$3.3V \pm 0.3V$	2.7V	$2.5V \pm 0.2V$
V_{mi}	1.5V	1.5V	$V_{CC}/2$
V_{mo}	1.5V	1.5V	$V_{CC}/2$
V_x	$V_{OL} + 0.3V$	$V_{OL} + 0.3V$	$V_{OL} + 0.15V$
V_y	$V_{OH} - 0.3V$	$V_{OH} - 0.3V$	$V_{OH} - 0.15V$

Physical Dimensions inches (millimeters) unless otherwise noted



**56-Lead Shrink Small Outline Package (SSOP), JEDEC MO-118, 0.300" Wide
Package Number MS56A**

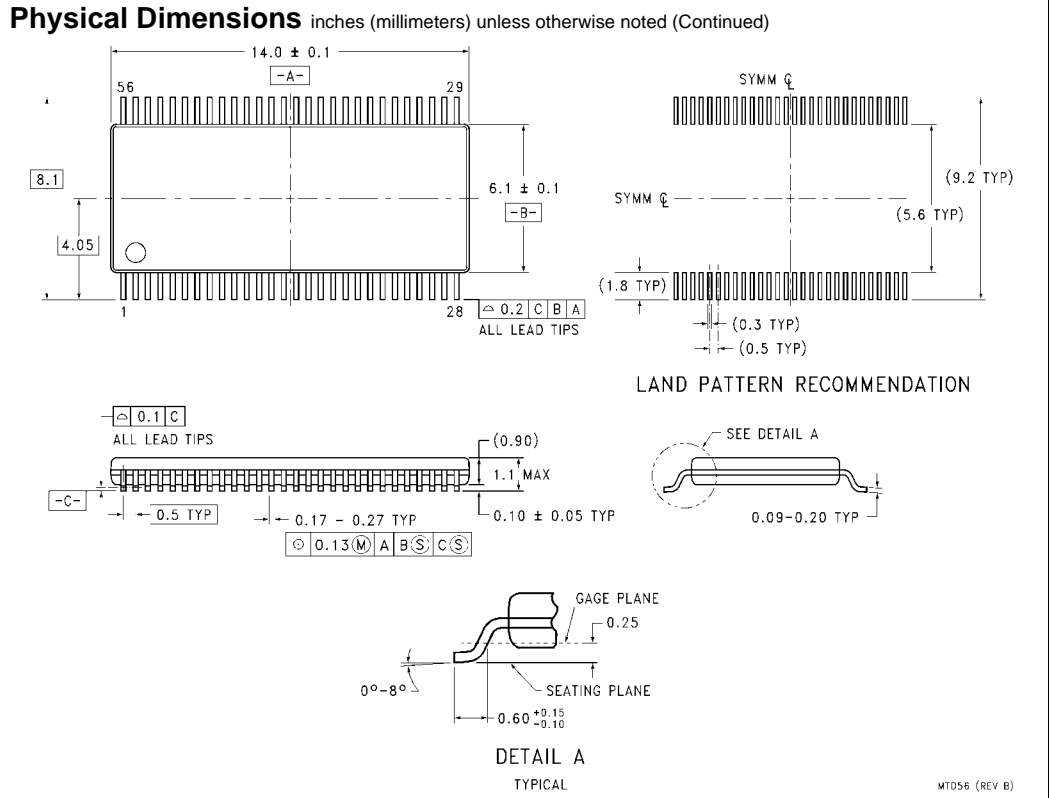

56-Lead Thin Shrink Small Outline Package (TSSOP), JEDEC MO-153, 6.1mm Wide
Package Number MTD56

LIFE SUPPORT POLICY

FAIRCHILD'S PRODUCTS ARE NOT AUTHORIZED FOR USE AS CRITICAL COMPONENTS IN LIFE SUPPORT DEVICES OR SYSTEMS WITHOUT THE EXPRESS WRITTEN APPROVAL OF THE PRESIDENT OF FAIRCHILD SEMICONDUCTOR CORPORATION. As used herein:

1. Life support devices or systems are devices or systems which, (a) are intended for surgical implant into the body, or (b) support or sustain life, and (c) whose failure to perform when properly used in accordance with instructions for use provided in the labeling, can be reasonably expected to result in a significant injury to the user.
2. A critical component in any component of a life support device or system whose failure to perform can be reasonably expected to cause the failure of the life support device or system, or to affect its safety or effectiveness.

www.fairchildsemi.com

Fairchild does not assume any responsibility for use of any circuitry described, no circuit patent licenses are implied and Fairchild reserves the right at any time without notice to change said circuitry and specifications.