



EMIF01-5250SC5

Application Specific Discretés
A.S.D.™

EMI FILTER WITH ESD PROTECTION

MAIN APPLICATIONS

Where EMI filtering in ESD sensitive equipment is required :

- Mobile phone : handsets and accessories
- RF communications

DESCRIPTION

The EMIF01-5250SC5 is a highly integrated T-filter designed to suppress EMI / RFI noise on I/O ports of mobile phones or RF communication equipment.

This filter includes ESD protection circuitry which prevents device destruction when subjected to ESD discharges.

The comprehensive layout of the EMIF01-5250SC5 filter allows design flexibility on high density boards.

FEATURES

- T-filtering functions for 2 wires.
- ESD protection of 15 kV (air discharge) per IEC1000-4-2
- Breakdown voltage : $V_{BR} = 6 \text{ V min.}$
- Low leakage current $< 1 \mu\text{A.}$

BENEFITS

- EMI / RFI noise suppression.
- Enhanced ESD protection : IEC1000-4-2 level 4
- One of the smallest protection circuits available
- High flexibility in the design of high density boards

COMPLIES WITH THE FOLLOWING STANDARDS

IEC 1000-4-2 15kV (air discharge)
8 kV (contact discharge)

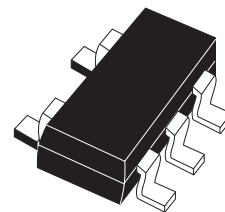

SOT23-5L (SC-59A)

FUNCTIONAL DIAGRAM

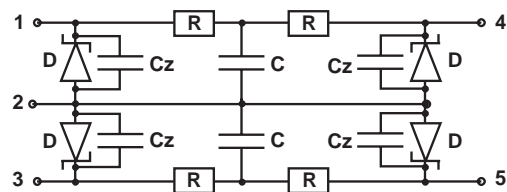

R = 52Ω tolerance $\pm 15\%$

C = 50 pF tolerance $\pm 15\%$

D = Zener diode

Cz = Capacitance of the zener diode

EMIF01-5250SC5

ABSOLUTE MAXIMUM RATINGS ($T_{amb} = 25\text{ }^{\circ}\text{C}$)

Symbol	Parameter and test conditions	Value	Unit
V_{PP}	ESD discharge IEC1000-4-2, air discharge	15	kV
	ESD discharge IEC1000-4-2, contact discharge	8	
T_j	Junction temperature	150	$^{\circ}\text{C}$
T_{op}	Operating temperature range	-30 to + 85	$^{\circ}\text{C}$
T_{stg}	Storage temperature range	-55 to +150	$^{\circ}\text{C}$
T_L	Lead temperature for soldering during 10s	260	$^{\circ}\text{C}$

ELECTRICAL CHARACTERISTICS of the ZENER DIODE ($T_{amb} = 25\text{ }^{\circ}\text{C}$)

Symbol	Parameter
V_{BR}	Breakdown voltage
I_{RM}	Leakage current
R_d	Dynamic impedance
C_z	Zener capacitance
t_{rr}	Reverse recovery time

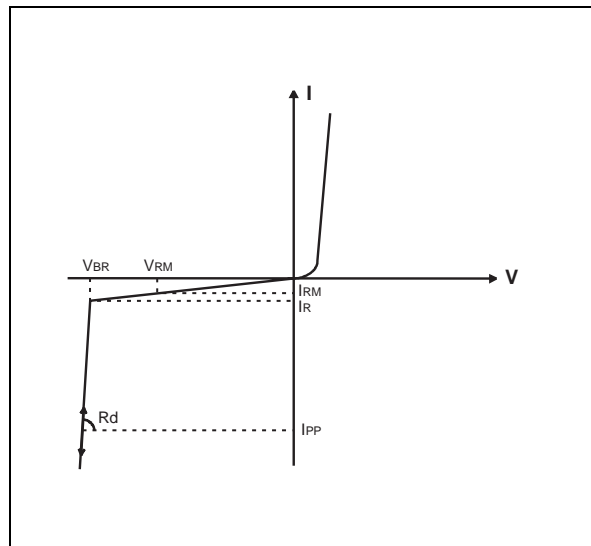

Symbol	Test conditions	Min.	Typ.	Max.	Unit
V_{BR}	$I_R = 1\text{ mA}$	6	7	8	V
I_{RM}	$V_{RM} = 3\text{ V}$			1	μA
R_d	$I_{pp} = 10\text{ A}$, $t_p = 2.5\text{ }\mu\text{s}$		0.55		Ω
C_z	0 V bias, $V_{RMS} = 30\text{ mV}$, $F = 1\text{ MHz}$		90		pF
t_{rr}	$I_F = 10\text{ mA}$, $dI_F/dt = 20\text{ A}/\mu\text{s}$, $R_L = 100\text{ }\Omega$, $T_j = 25\text{ }^{\circ}\text{C}$		40		ns

ATTENUATION BEHAVIOR

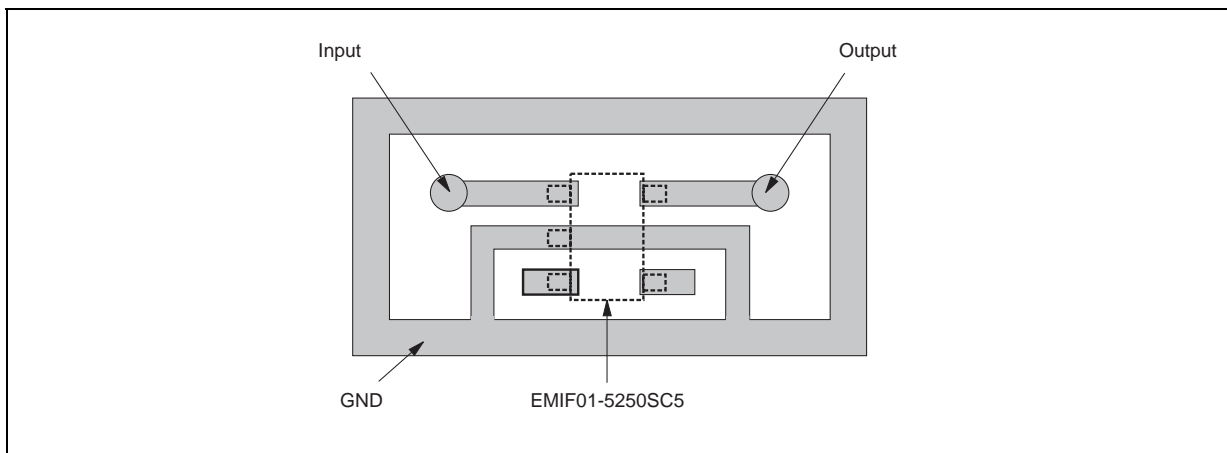
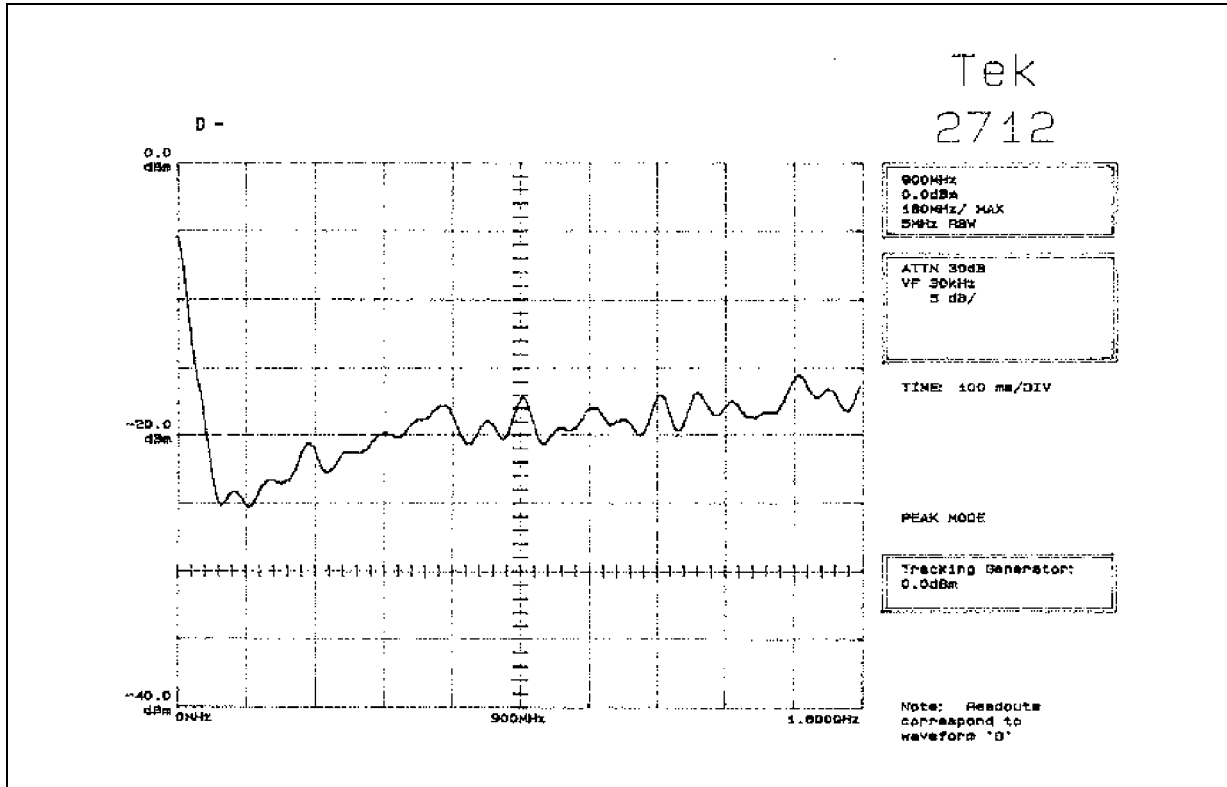

EMIF01-5250SC5

ESD BEHAVIOR

Fig 2 : ESD measurement conditions

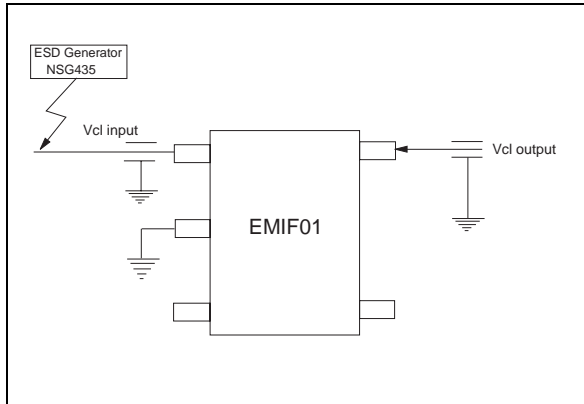

Fig 3 : ESD behavior on IEC1000-4-2 air discharge at input (typical value)

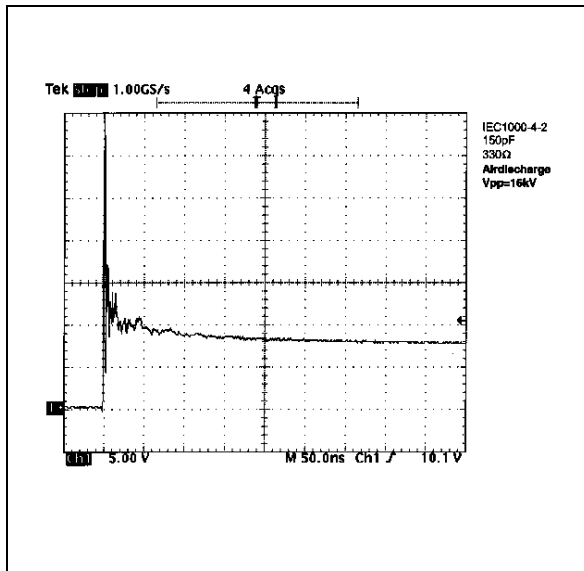
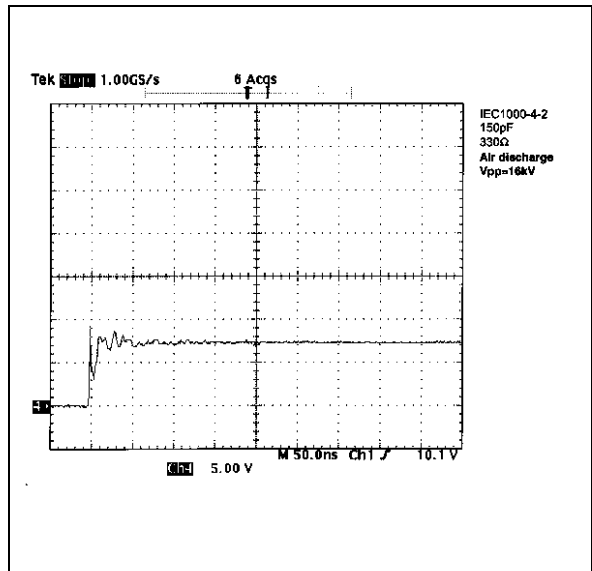
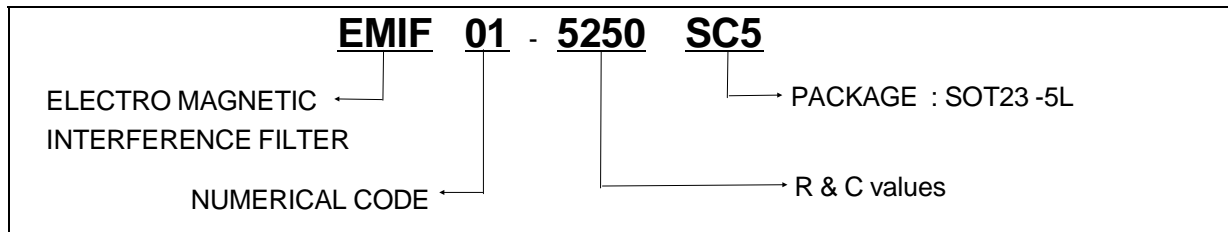

Fig 4 : ESD behavior on IEC1000-4-2 air discharge at output (typical value)



Figures 3 and 4 show the EMIF01-5250SC5 response to air and contact discharge conditions respectively at input and output pins. These figures indicate that the response is spontaneous and the output level is kept at safe operating voltages.

ORDER CODE



MARKING

Type & order code	Marking	Packaging	Base qty (pcs)
EMIF01-5250SC5	EMIF	tape & reel	3000

PACKAGE MECHANICAL DATA

REF.	DIMENSIONS					
	Millimeters			Inches		
	Min.	Typ.	Max.	Min.	Typ.	Max.
A	0.90		1.45	0.035		0.057
A1	0		0.15	0		0.006
A2	0.90		1.30	0.035		0.0512
b	0.35		0.50	0.0137		0.02
c	0.09		0.20	0.004		0.008
D	2.80		3.00	0.11		0.118
E	1.50		1.75	0.059		0.0689
e		0.95			0.0374	
H	2.60		3.00	0.102		0.118
L	0.10		0.60	0.004		0.024
M			10°			10°

RECOMMENDED FOOT PRINT

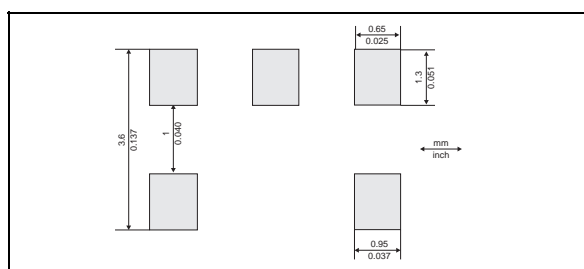

Information furnished is believed to be accurate and reliable. However, STMicroelectronics assumes no responsibility for the consequences of use of such information nor for any infringement of patents or other rights of third parties which may result from its use. No license is granted by implication or otherwise under any patent or patent rights of STMicroelectronics. Specifications mentioned in this publication are subject to change without notice. This publication supersedes and replaces all information previously supplied. STMicroelectronics products are not authorized for use as critical components in life support devices or systems without express written approval of STMicroelectronics.

The ST logo is a registered trademark of STMicroelectronics

© 1998 STMicroelectronics - Printed in Italy - All rights reserved.

STMicroelectronics GROUP OF COMPANIES

Australia - Brazil - Canada - China - France - Germany - Italy - Japan - Korea - Malaysia - Malta - Mexico - Morocco - The Netherlands - Singapore - Spain - Sweden - Switzerland - Taiwan - Thailand - United Kingdom - U.S.A.

<http://www.st.com>

