

70A, 30V, Avalanche Rated N-Channel Enhancement-Mode Power MOSFETs

December 1995

Features

- 70A, 30V
- $r_{DS(ON)} = 0.010\Omega$
- Temperature Compensating PSPICE Model
- Peak Current vs Pulse Width Curve
- UIS Rating Curve (Single Pulse)
- +175°C Operating Temperature

Description

The RFP70N03, RF1S70N03, and RF1S70N03SM N-Channel power MOSFETs are manufactured using the MegaFET process. This process, which uses feature sizes approaching those of LSI integrated circuits gives optimum utilization of silicon, resulting in outstanding performance. They were designed for use in applications such as switching regulators, switching converters, motor drivers, relay drivers and emitter switches for bipolar transistors. These transistors can be operated directly from integrated circuits.

PACKAGE AVAILABILITY

PART NUMBER	PACKAGE	BRAND
RFP70N03	TO-220AB	RFP70N03
RF1S70N03	TO-262AA	F1S70N03
RF1S70N03SM	TO-263AB	F1S70N03

NOTE: When ordering use the entire part number. Add the suffix, 9A, to obtain the TO-263AB variant in tape and reel, e.g. RF1S70N03SM9A.

Formerly developmental type TA49025.

Packages

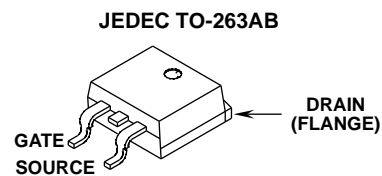
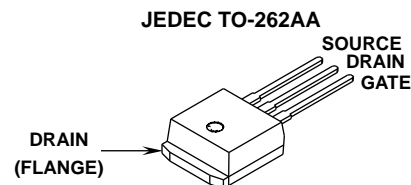
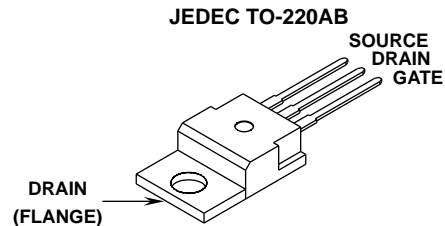

Symbol

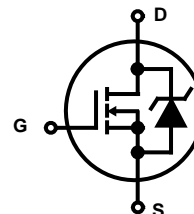

Absolute Maximum Ratings $T_C = +25^\circ\text{C}$, Unless Otherwise Specified

	RFP70N03, RF1S70N03, RF1S70N03SM	UNITS
Drain-Source Voltage	V_{DSS} 30	V
Drain-Gate Voltage	V_{DGR} 30	V
Gate-Source Voltage	V_{GS} ± 20	V
Continuous Drain Current		
RMS Continuous	I_D 70	A
Pulsed Drain Current	I_{DM} 200	A
Single Pulse Avalanche Rating	E_{AS} (Refer to UIS Curve)	
Power Dissipation		
$T_C = +25^\circ\text{C}$	P_D 150	W
Above $T_C = +25^\circ\text{C}$, Derate Linearly	P_T 1.0	W/°C
Operating and Storage Junction Temperature Range	T_J, T_{STG} -55 to +175	°C

Specifications RFP70N03, RF1S70N03, RF1S70N03SM

Electrical Specifications At Case Temperature (T_C) = +25°C, Unless Otherwise Specified

PARAMETERS	SYMBOL	TEST CONDITIONS	MIN	TYP	MAX	UNITS	
Drain-Source Breakdown Voltage	BV_{DSS}	$I_D = 250\mu A, V_{GS} = 0V$	30	-	-	V	
Gate Threshold Voltage	$V_{GS(TH)}$	$V_{GS} = V_{DS}, I_D = 250\mu A$	2	-	4	V	
Zero Gate Voltage Drain Current	I_{DSS}	$V_{DS} = 30V$ $V_{GS} = 0V$	$T_C = 25^\circ C$	-	-	1	μA
			$T_C = 150^\circ C$	-	-	50	μA
Gate-Source Leakage Current	I_{GSS}	$V_{GS} = \pm 20V$	-	-	100	nA	
On Resistance	$r_{DS(ON)}$	$I_D = 70A, V_{GS} = 10V$	-	-	0.010	Ω	
Turn-On Time	t_{ON}	$V_{DD} = 15V, I_D = 70A$ $R_L = 0.214\Omega, V_{GS} = +10V$ $R_{GS} = 2.5\Omega$	-	-	80	ns	
Turn-On Delay Time	$t_{D(ON)}$		-	20	-	ns	
Rise Time	t_R		-	20	-	ns	
Turn-Off Delay Time	$t_{D(OFF)}$		-	40	-	ns	
Fall Time	t_F		-	25	-	ns	
Turn-Off Time	t_{OFF}		-	-	125	ns	
Total Gate Charge	$Q_{G(TOT)}$		$V_{GS} = 0 \text{ to } 20V$	-	215	260	nC
Gate Charge at 10V	$Q_{G(10)}$		$V_{GS} = 0 \text{ to } 10V$				
Threshold Gate Charge	$Q_{G(TH)}$	$V_{GS} = 0 \text{ to } 2V$					
Input Capacitance	C_{ISS}	$V_{DS} = 25V, V_{GS} = 0V$ $f = 1MHz$	-	3300	-	pF	
Output Capacitance	C_{OSS}		-	1750	-	pF	
Reverse Transfer Capacitance	C_{RSS}		-	750	-	pF	
Thermal Resistance Junction to Case	$R_{\theta JC}$		-	-	1.0	$^\circ C/W$	
Thermal Resistance Diode Junction to Ambient	$R_{\theta JA}$		-	-	80	$^\circ C/W$	

Source-Drain Diode Ratings and Specifications

PARAMETERS	SYMBOL	TEST CONDITIONS	MIN	TYP	MAX	UNITS
Diode Forward Voltage	V_{SD}	$I_{SD} = 70A$	-	-	1.5	V
Reverse Recovery Time	t_{RR}	$I_{SD} = 70A, dI_{SD}/dt = 100A/\mu s$	-	-	125	ns

Typical Performance Curves

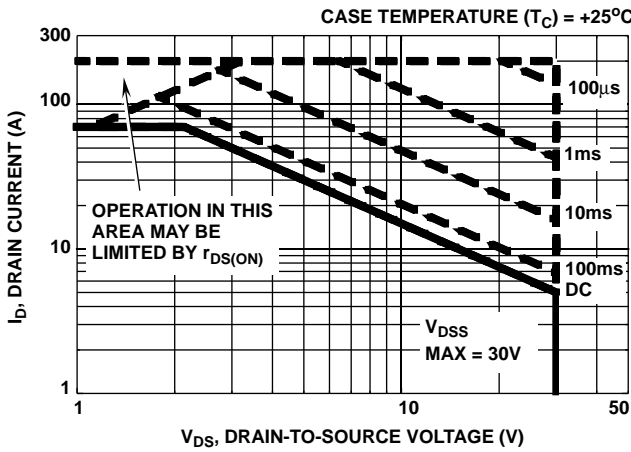

FIGURE 1. SAFE-OPERATING AREA CURVE

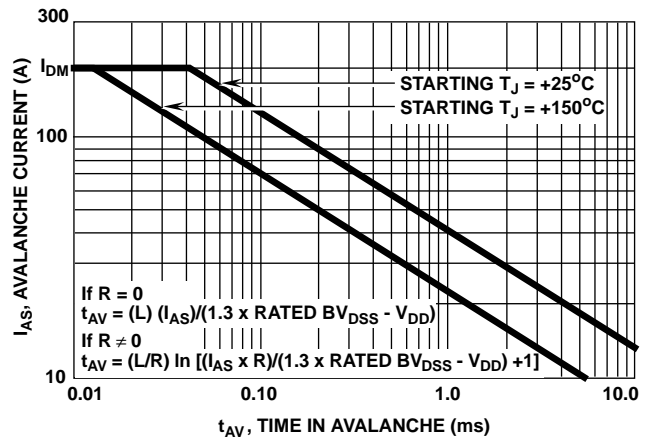

FIGURE 2. UNCLAMPED INDUCTIVE-SWITCHING

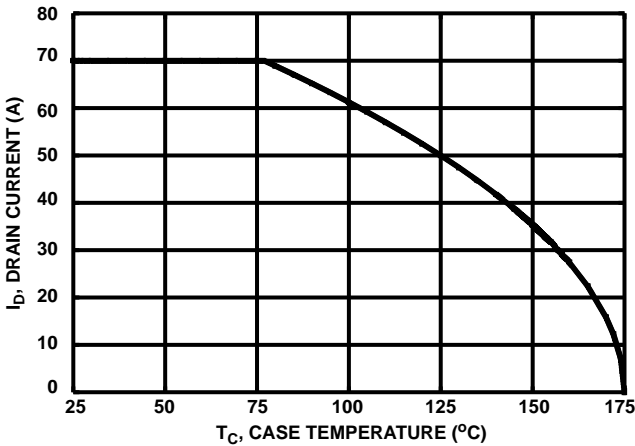

FIGURE 3. MAXIMUM CONTINUOUS DRAIN CURRENT vs TEMPERATURE

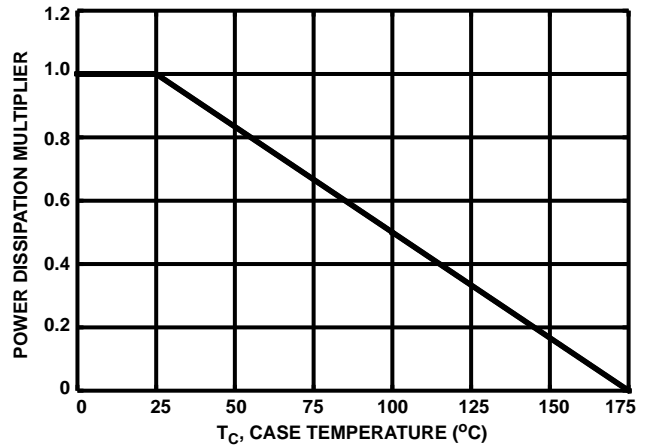

FIGURE 4. NORMALIZED POWER DISSIPATION vs TEMPERATURE DERATING CURVE

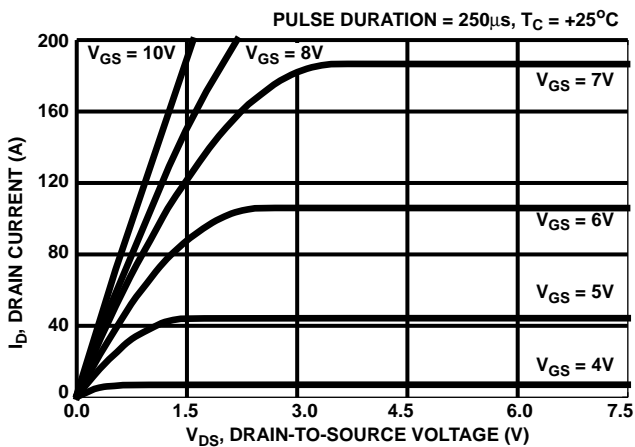

FIGURE 5. TYPICAL SATURATION CHARACTERISTICS

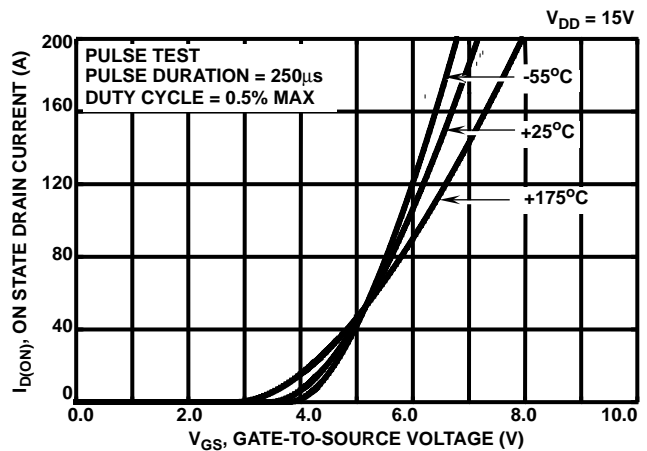

FIGURE 6. TYPICAL TRANSFER CHARACTERISTICS

Typical Performance Curves (Continued)

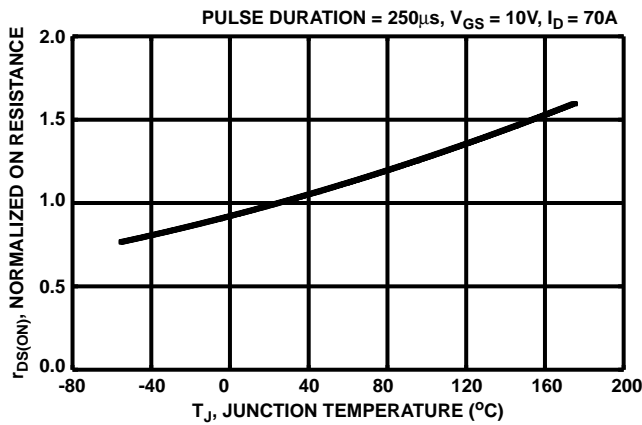

FIGURE 7. NORMALIZED $r_{DS(ON)}$ vs JUNCTION TEMPERATURE

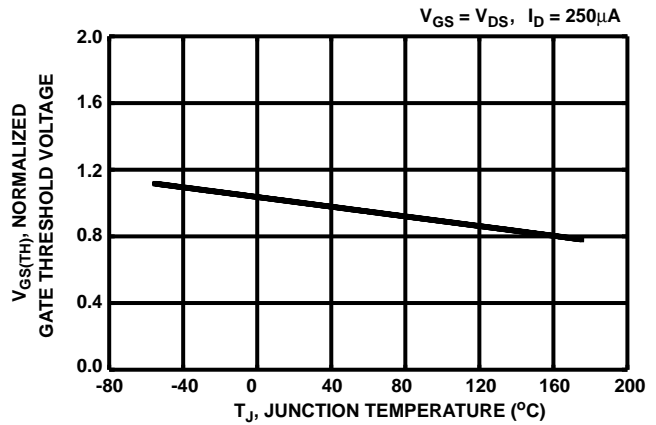

FIGURE 8. NORMALIZED GATE THRESHOLD VOLTAGE vs TEMPERATURE

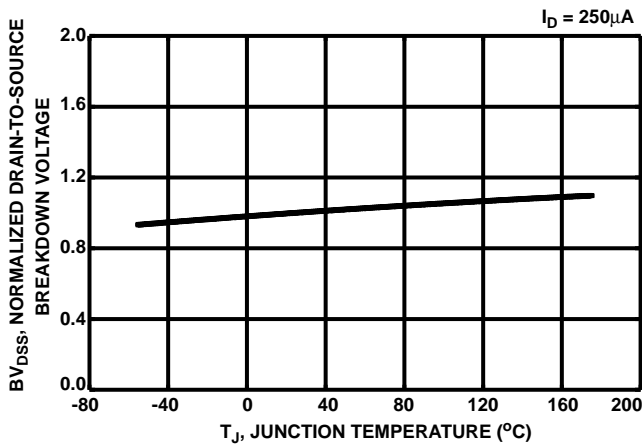

FIGURE 9. NORMALIZED DRAIN SOURCE BREAKDOWN VOLTAGE vs TEMPERATURE

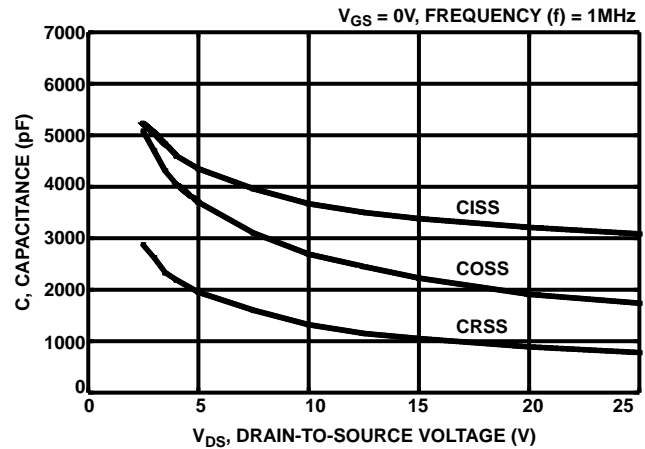

FIGURE 10. TYPICAL CAPACITANCE vs VOLTAGE

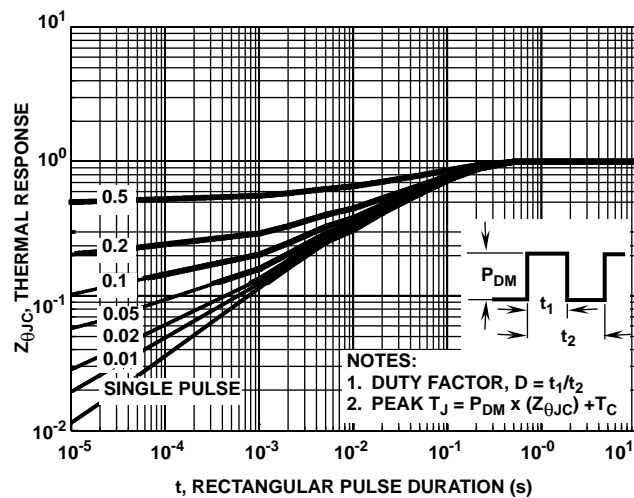

FIGURE 11. NORMALIZED MAXIMUM TRANSIENT THERMAL IMPEDANCE

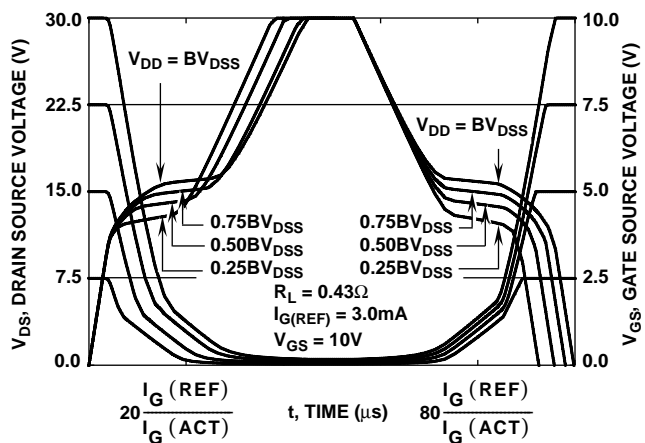

FIGURE 12. NORMALIZED SWITCHING WAVEFORMS FOR CONSTANT GATE CURRENT. REFER TO HARRIS APPLICATION NOTES AN7254 AND AN7260

Test Circuits and Waveforms

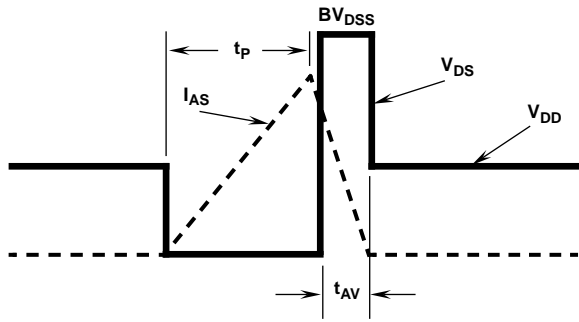

FIGURE 13. UNCLAMPED ENERGY WAVEFORMS

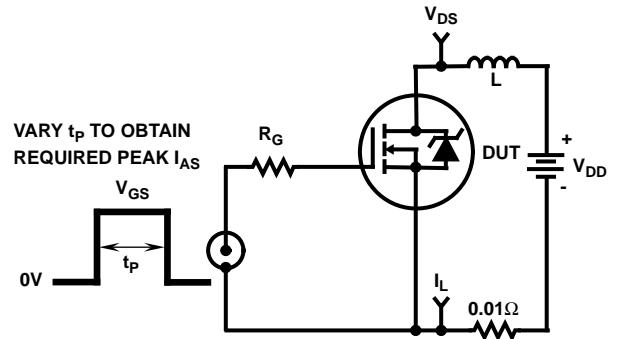

FIGURE 14. UNCLAMPED ENERGY TEST CIRCUIT

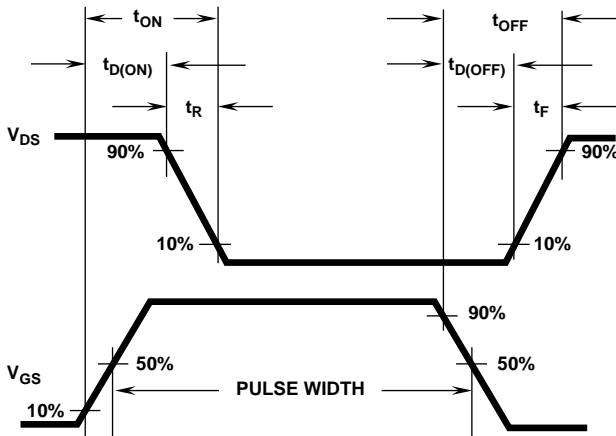

FIGURE 15. RESISTIVE SWITCHING WAVEFORMS

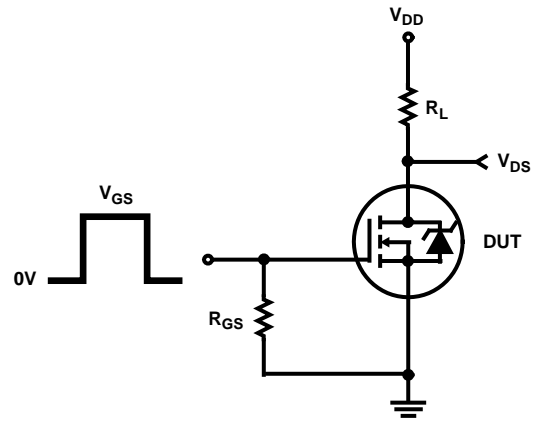

FIGURE 16. RESISTIVE SWITCHING TEST CIRCUIT

