



15 kV ESD Protected, +2.7 V to +3.6 V Serial Port Transceiver with Green Idle™

ADM3311E*

FEATURES

- Green Idle Power Saving Mode
- Full RS-232 Compliance
- Operates with 3 V Logic
- Low EMI
- Ultralow Power CMOS: 450 μ A Operation
- Low Power Shutdown: 20 nA
- 460 kbits/s Data Rate
- 0.1 μ F to 1 μ F Charge Pump Capacitors
- Single +2.7 V to +3.6 V Power Supply
- One Receiver Active in Shutdown
- ESD >15 kV
- Pin Compatible with DS14C335

APPLICATIONS

- Laptop Computers
- Notebook Computers
- Printers
- Peripherals
- Modems

GENERAL DESCRIPTION

The ADM3311E is a three driver/five receiver product designed to fully meet the EIA-232 standard while operating with a single +2.7 V to +3.6 V power supply. The device features an on-board, charge pump, dc-to-dc converter, eliminating the need for dual power supplies. This dc-to-dc converter contains a voltage tripler and voltage inverter, which internally generates positive and negative supplies from the input +3 V power supply. The dc-to-dc converter operates in Green Idle Mode, whereby the charge pump oscillator is gated on and off to maintain the output voltage at ± 7.25 V under varying load conditions. This minimizes the power consumption and makes these products ideal for battery powered portable devices.

The ADM3311E is suitable for operation in harsh electrical environments and contains ESD protection up to ± 15 kV on all I-O lines.

The ADM3311E contains three drivers and five receivers and is intended for serial port applications on notebook/laptop computers.

FUNCTIONAL BLOCK DIAGRAM

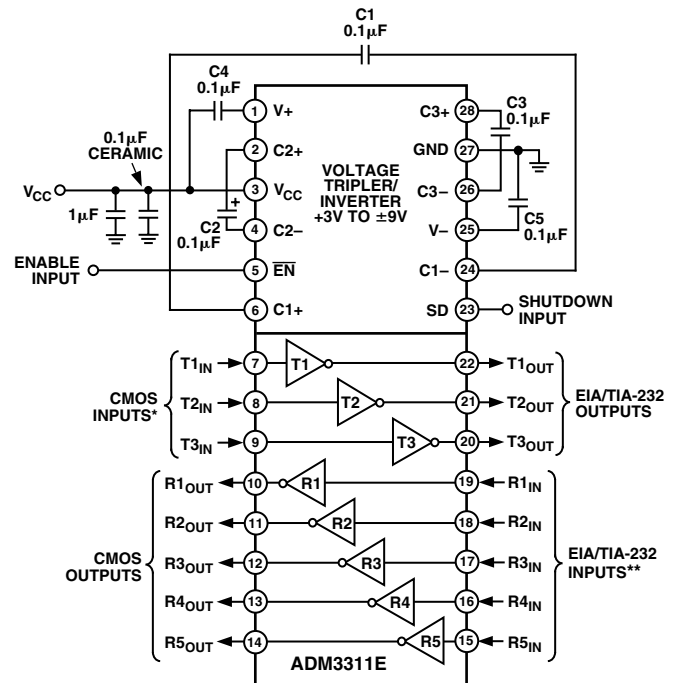

- NOTES:
* INTERNAL 400k Ω PULL-UP RESISTOR ON EACH CMOS INPUT
** INTERNAL 5k Ω PULL-DOWN RESISTOR ON EACH RS-232 INPUT

A shutdown facility is also provided that reduces the power consumption to 3 μ W. While in shutdown, one receiver remains active, thereby allowing monitoring of peripheral devices. This feature allows the device to be shut down until a peripheral device begins communication. The active receiver can alert the processor, which can then take the ADM3311E out of the shutdown mode.

The ADM3311E is fabricated using CMOS technology for minimal power consumption. It features a high level of over-voltage protection and latch-up immunity.

The ADM3311E is packaged in a 28-lead SSOP/TSSOP package.

*Protected by Patent No. 5,606,491.
Green Idle is a trademark of Analog Devices, Inc.

REV. A

Information furnished by Analog Devices is believed to be accurate and reliable. However, no responsibility is assumed by Analog Devices for its use, nor for any infringements of patents or other rights of third parties which may result from its use. No license is granted by implication or otherwise under any patent or patent rights of Analog Devices.

ADM3311E—SPECIFICATIONS ($V_{CC} = +2.7\text{ V to }+3.6\text{ V}$, $C1-C5 = 0.1\ \mu\text{F}$. All specifications T_{MIN} to T_{MAX} unless otherwise noted.)

Parameter	Min	Typ	Max	Units	Test Conditions/Comments
Operating Voltage Range	+2.7	+3.3	+3.6	V	
V_{CC} Power Supply Current		0.45	1	mA	$V_{CC} = 3.0\text{ V to }3.6\text{ V}$, $T_A = 0^\circ\text{C to }+85^\circ\text{C}$, No Load
		0.45	4.5	mA	$V_{CC} = 2.7\text{ V to }3.6\text{ V}$, $T_A = -40^\circ\text{C to }+85^\circ\text{C}$, No Load
Shutdown Supply Current		0.02	1	mA	$R_L = 3\text{ k}\Omega$ to GND on all T_{OUTS}
Input Pull-Up Current		10	25	μA	$T_{IN} = \text{GND}$
Input Leakage Current, $\overline{\text{SD}}$, $\overline{\text{EN}}$			± 1	μA	
Input Logic Threshold Low, V_{INL}			0.8	V	T_{IN} , $\overline{\text{EN}}$, $\overline{\text{SD}}$
			0.4	V	T_{IN} , $\overline{\text{EN}}$, $\overline{\text{SD}}$, $V_{CC} = 2.7\text{ V}$
Input Logic Threshold High, V_{INH}	2.0			V	T_{IN} , $\overline{\text{EN}}$, $\overline{\text{SD}}$
CMOS Output Voltage Low, V_{OL}			0.4	V	$I_{OUT} = 1.6\text{ mA}$
CMOS Output Voltage High, V_{OH}	$V_{CC} - 0.6$			V	$I_{OUT} = -200\ \mu\text{A}$
CMOS Output Leakage Current		0.05	± 5	μA	$\overline{\text{EN}} = V_{CC}$, $0\text{ V} < R_{OUT} < V_{CC}$
Charge Pump Output Voltage, $V+$		7.25		V	No Load
Charge Pump Output Voltage, $V-$		-7.25		V	No Load
EIA-232 Input Voltage Range	-25		+25	V	
EIA-232 Input Threshold Low	0.4	1.3		V	
EIA-232 Input Threshold High		2.0	2.4	V	
EIA-232 Input Hysteresis		0.14		V	
EIA-232 Input Resistance	3	5	7	k Ω	
Output Voltage Swing ($V_{CC} = 3.0\text{ V}$)	± 5.0	± 6.4		V	All Transmitter Outputs
Output Voltage Swing ($V_{CC} = 2.7\text{ V}$)		± 5.5		V	Loaded with $3\text{ k}\Omega$ to Ground
Transmitter Output Resistance	300			Ω	$V_{CC} = 0\text{ V}$, $V_{OUT} = \pm 2\text{ V}$
RS-232 Output Short Circuit Current		± 15	± 60	mA	
Maximum Data Rate		460		kbps	$R_L = 3\text{ k}\Omega$ to $7\text{ k}\Omega$, $C_L = 50\text{ pF to }1000\text{ pF}$
Receiver Propagation Delay, T_{PHL} , T_{PLH}		0.3		μs	$C_L = 150\text{ pF}$
Receiver Output Enable Time, t_{ER}		100		ns	
Receiver Output Disable Time, t_{DR}		300		ns	
Transmitter Propagation Delay, T_{PHL} , T_{PLH}		500		ns	$R_L = 3\text{ k}\Omega$, $C_L = 1000\text{ pF}$
Transition Region Slew Rate	6	18		V/ μs	$R_L = 3\text{ k}\Omega$, $C_L = 50\text{ pF to }1000\text{ pF}$, Measured from $+3\text{ V to }-3\text{ V}$ or $-3\text{ V to }+3\text{ V}$
ESD Protection (I-O Pins)		± 8		kV	IEC1000-4-2 Contact Discharge
		± 15		kV	IEC1000-4-2 Air Discharge
ESD Protection (All Other Pins)		± 3.0		kV	Human Body Model, MIL-STD-883B
EFT Protection (I-O Pins)		± 4		kV	IEC1000-4-4
EMI Immunity		10		V/m	IEC1000-4-3

Specifications subject to change without notice.

ABSOLUTE MAXIMUM RATINGS*

($T_A = +25^\circ\text{C}$ unless otherwise noted)

V_{CC}	-0.3 V to +4 V
$V+$	($V_{CC} - 0.3\text{ V}$) to +8 V
$V-$	+0.3 V to -8 V
Input Voltages	
T_{IN}	-0.3 V to +6 V
R_{IN}	$\pm 30\text{ V}$
Output Voltages	
T_{OUT}	$\pm 15\text{ V}$
R_{OUT}	-0.3 V to ($V_{CC} + 0.3\text{ V}$)
Short Circuit Duration	
T_{OUT}	Continuous
Power Dissipation	
RU-28 TSSOP (Derate 12 mW/ $^\circ\text{C}$ Above $+70^\circ\text{C}$)	900 mW
RS-28 SSOP (Derate 10 mW/ $^\circ\text{C}$ Above $+70^\circ\text{C}$)	900 mW

Operating Temperature Range

Industrial (A Version)	-40 $^\circ\text{C}$ to +85 $^\circ\text{C}$
Storage Temperature Range	-65 $^\circ\text{C}$ to +150 $^\circ\text{C}$
Lead Temperature (Soldering, 10 sec)	+300 $^\circ\text{C}$
ESD Rating (MIL-STD-883B) (I-O Pins)	$\pm 15\text{ kV}$
ESD Rating (MIL-STD-883B) (Except I-O)	$\pm 3.0\text{ kV}$
ESD Rating (IEC1000-4-2 Contact) (I-O Pins)	$\pm 8\text{ kV}$
ESD Rating (IEC1000-4-2 Air) (I-O Pins)	$\pm 15\text{ kV}$
EFT Rating (IEC1000-4-4) (I-O Pins)	$\pm 4\text{ kV}$

*This is a stress rating only and functional operation of the device at these or any other conditions above those indicated in the operation sections of this specification is not implied. Exposure to absolute maximum rating conditions for extended periods of time may affect reliability.

PIN FUNCTION DESCRIPTIONS

Mnemonic	Function
V _{CC}	Power Supply Input +2.7 V to +3.6 V. Requires capacitor of 1 μF or greater to GND.
V+	Internally generated positive supply (+7.25 V nominal) Capacitor C4 is connected between V _{CC} and V+.
V-	Internally generated negative supply (-7.25 V nominal) Capacitor C5 is connected between V- and GND.
GND	Ground Pin. Must be connected to 0 V.
C1+, C1-	External capacitor 1 is connected between these pins. A 0.1 μF capacitor is recommended, but larger capacitors up to 1 μF may be used.
C2+, C2-	External capacitor 2 is connected between these pins. A 0.1 μF capacitor is recommended, but larger capacitors up to 1 μF may be used.
C3+, C3-	External capacitor 3 is connected between these pins. A 0.1 μF capacitor is recommended, but larger capacitors up to 1 μF may be used.
T _{IN}	Transmitter (Driver) Inputs. These inputs accept TTL/CMOS levels. An internal 400 kΩ pull-up resistor to V _{CC} is connected on each input.
T _{OUT}	Transmitter (Driver) Outputs, (typically ±6.4 V).
R _{IN}	Receiver Inputs. These inputs accept RS-232 signal levels. An internal 5 kΩ pull-down resistor to GND is connected on each of these inputs.
R _{OUT}	Receiver Outputs. These are TTL/CMOS levels.
$\overline{\text{EN}}$	Receiver Enable. A high level three-states all the receiver outputs.
SD	Shutdown Control. A high level will disable the charge pump and reduce the quiescent current to 20 nA. All transmitters and receivers R1-R4 are disabled. Receiver R5 remains active in shutdown.

Table I. Truth Table

SD	$\overline{\text{EN}}$	Status	T _{OUT} 1-3	R _{OUT} 1-4	R _{OUT} 5
0	0	Normal Operation	Enabled	Enabled	Enabled
0	1	Receivers Disabled	Enabled	Disabled	Disabled
1	0	Shutdown	Disabled	Disabled	Enabled
1	1	Shutdown	Disabled	Disabled	Disabled

PIN CONFIGURATION

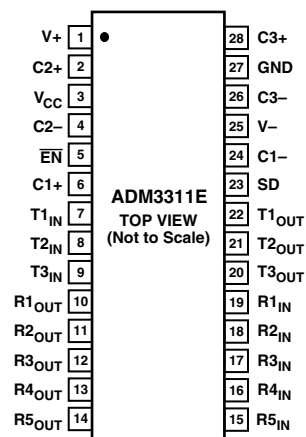

ORDERING GUIDE

Model	Temperature Range	Package Descriptions	Package Option
ADM3311EARS-Reel 2.5	-40°C to +85°C	28-Lead Shrink Small Outline (SSOP)	RS-28
ADM3311EARU-Reel 2.5	-40°C to +85°C	28-Lead Thin Shrink Small Outline (TSSOP)	RU-28

ADM3311E—Typical Performance Characteristics

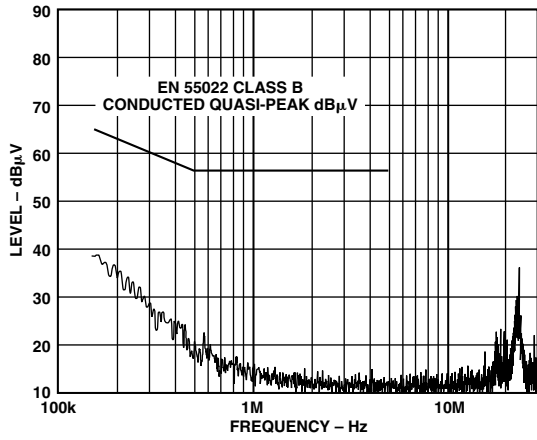

Figure 1. EMC Conducted Emissions

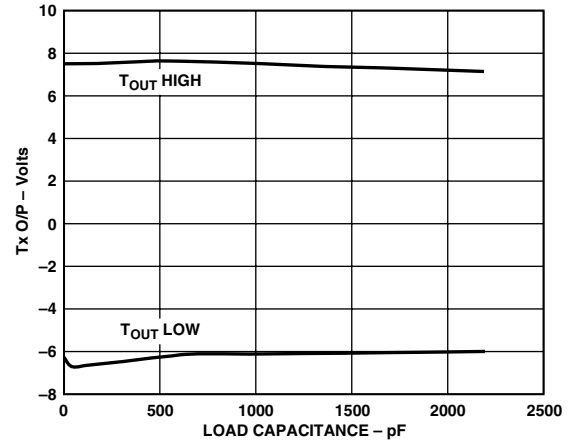

Figure 4. Transmitter Output High/Low vs. Load Capacitance

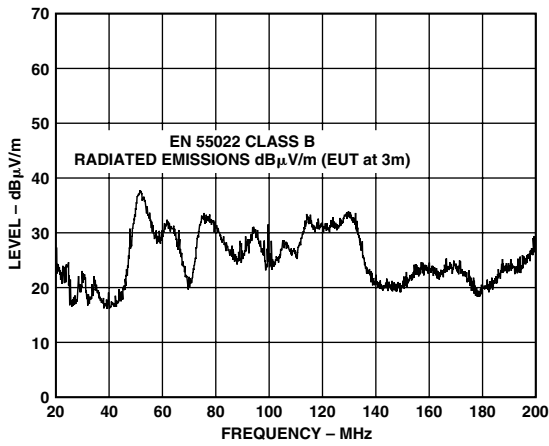

Figure 2. EMC Radiated Emissions

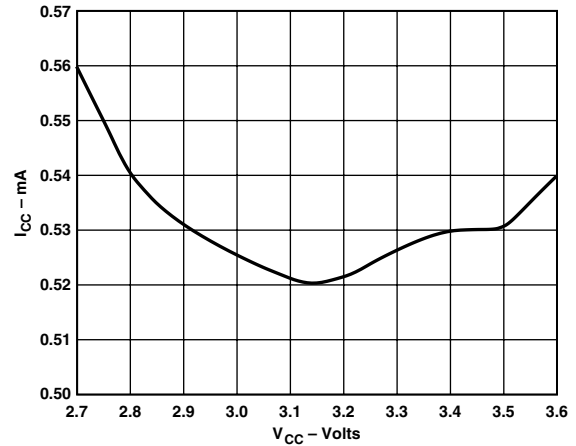

Figure 5. Power Supply Current vs. Power Supply Voltage (Unloaded)

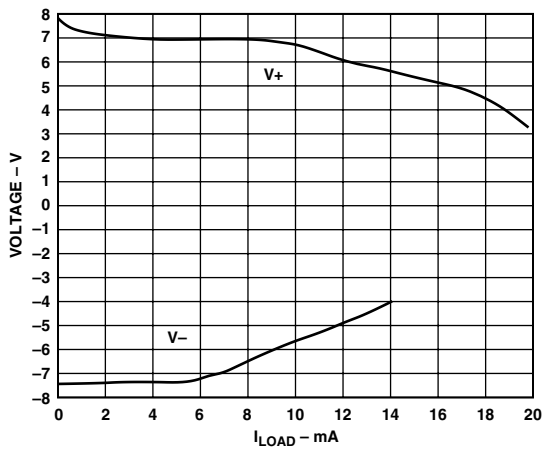

Figure 3. Charge Pump V_+ , V_- vs. Load Current

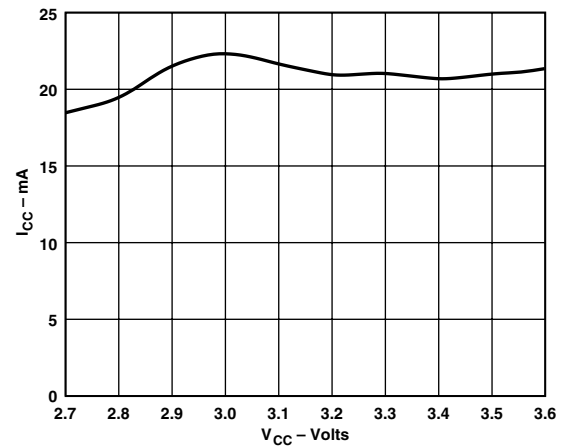

Figure 6. Power Supply Current vs. Power Supply Voltage ($R_L = 3\text{ k}\Omega$)

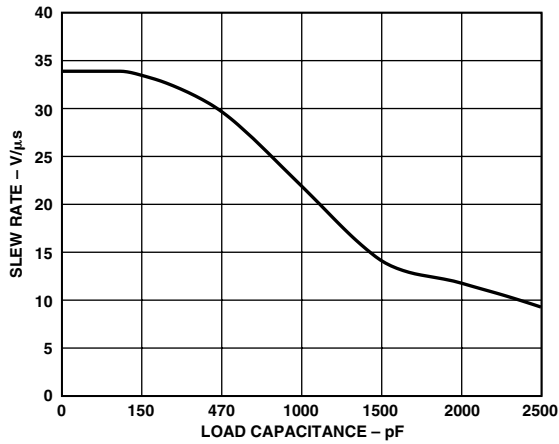

Figure 7. Slew Rate vs. Load Capacitance

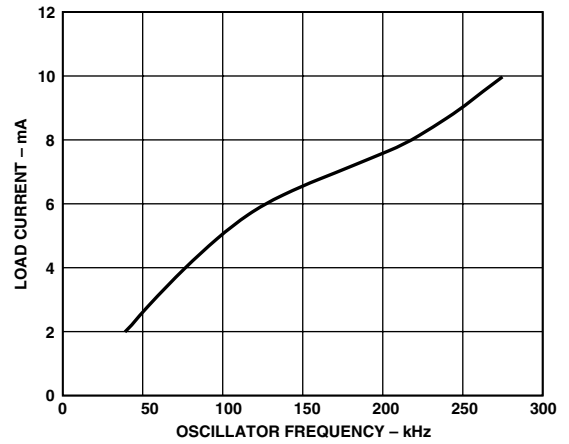

Figure 10. Load Current vs. Oscillator Frequency

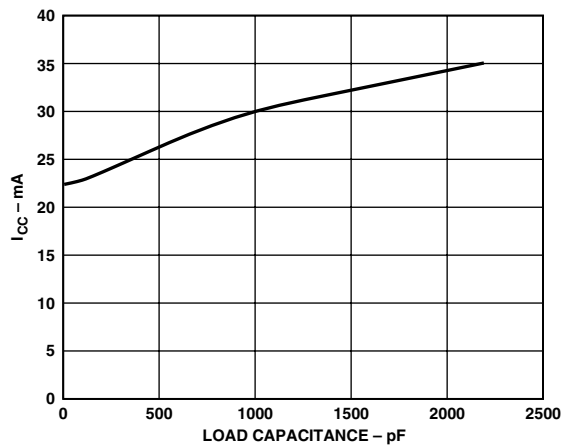

Figure 8. Supply Current vs. Load Capacitance ($R_L = 3\text{ k}\Omega$)

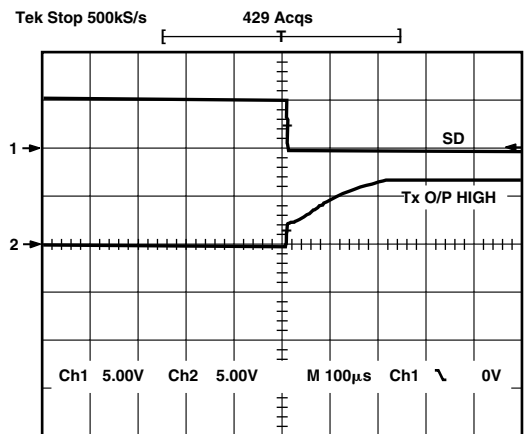

Figure 11. Transmitter Output (High) Exiting Shutdown

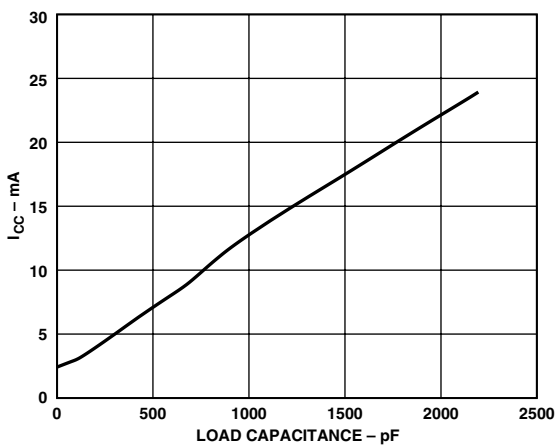

Figure 9. Supply Current vs. Load Capacitance ($R_L = \infty$)

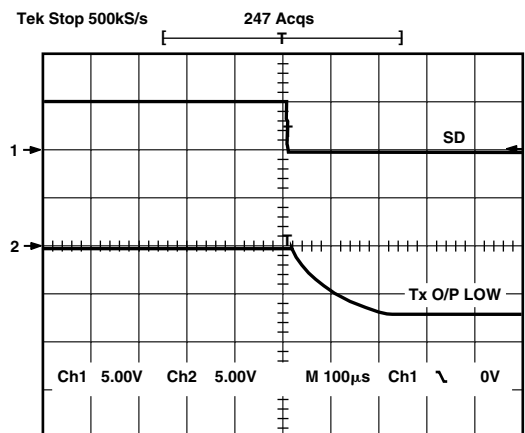

Figure 12. Transmitter Output (Low) Exiting Shutdown

ADM3311E

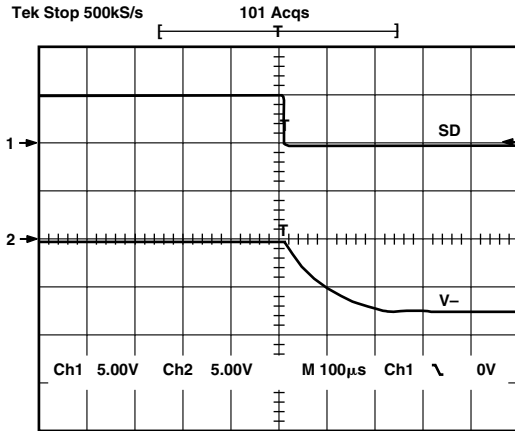

Figure 13. Charge Pump V- Exiting Shutdown

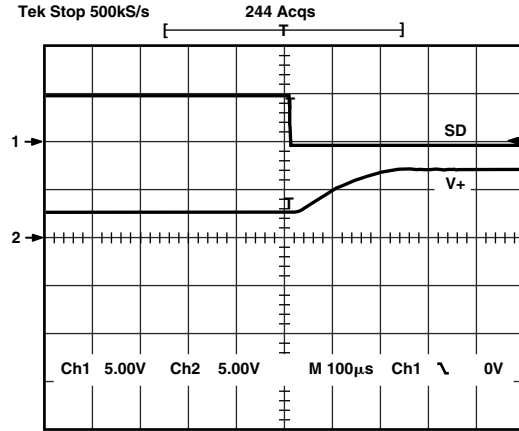

Figure 14. Charge Pump V+ Exiting Shutdown

GENERAL DESCRIPTION

The ADM3311E is a ruggedized RS-232 line driver/receiver that operates from a single supply of +2.7 V to +3.6 V. Step-up voltage converters, coupled with level-shifting transmitters and receivers, allow RS-232 levels to be developed while operating from a single supply. Features include low power consumption, Green Idle operation, high transmission rates and compatibility with the EU directive on electromagnetic compatibility. EM compatibility includes protection against radiated and conducted interference including high levels of electrostatic discharge.

All RS-232 inputs and outputs contain protection against electrostatic discharges up to ± 15 kV and electrical fast transients up to ± 4 kV.

The device is ideally suited for operation in electrically harsh environments or where RS-232 cables are frequently being plugged/unplugged, and is immune to high RF field strengths without special shielding precautions.

Emissions are also controlled to within very strict limits. CMOS technology is used to keep the power dissipation to an absolute minimum allowing maximum battery life in portable applications.

CIRCUIT DESCRIPTION

The internal circuitry consists of three main sections. These are:

1. A charge pump voltage converter.
2. 3.3 V logic to EIA-232 transmitters.
3. EIA-232 to 3 V logic receivers.
4. Transient protection circuit on all I-O lines.

Charge Pump DC-DC Voltage Converter

The charge pump voltage converter consists of a 180 kHz oscillator and a switching matrix. The converter generates a ± 9 V supply from the input +3.0 V level. This is done in two stages using a switched capacitor technique as illustrated below. First, the +3.0 V input supply is tripled to +9.0 V using capacitor C4 as the charge storage element. The +9.0 V level is then inverted to generate -9.0 V using C5 as the storage element.

However, it should be noted that, unlike other charge-pump dc-dc converters, the charge pump on the ADM3311E does not run open-loop. The output voltage is regulated to ± 7.25 V by the Green Idle circuit (as described later) and will never reach

± 9 V in practice. This saves power as well as maintaining a more constant output voltage.

The tripler operates in two phases. During the oscillator low phase, S1 and S2 are closed and C1 charges rapidly to V_{CC} . S3, S4 and S5 are open. S6 and S7 are closed.

During the oscillator high phase, S1 and S2 are open. S3 and S4 are closed, so the voltage at the output of S3 is $2V_{CC}$. This voltage is used to charge C2. In the absence of any discharge current, C2 will charge up to $2V_{CC}$ after a several cycles. During the oscillator high phase, as previously mentioned, S6 and S7 are closed, so the voltage at the output of S6 will be $3V_{CC}$. This voltage is used to charge C3.

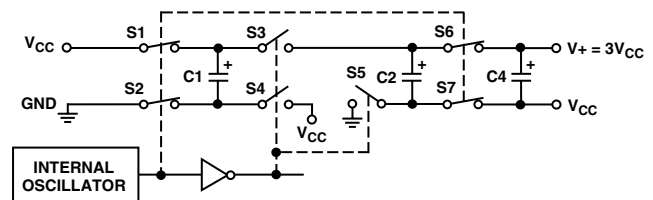

Figure 15. Charge Pump Voltage Tripler

The voltage inverter is illustrated in Figure 16. During the oscillator high phase S10 and S11 are open, S8 and S9 are closed and (over several cycles) C2 is charged to $+3V_{CC}$ from the output of the voltage tripler. During the oscillator low phase, S8 and S9 are open, while S10 and S11 are closed. C3 is connected across C5, whose positive terminal is grounded and whose negative terminal is the V- output. Over several cycles C5 charges to $-3V_{CC}$.

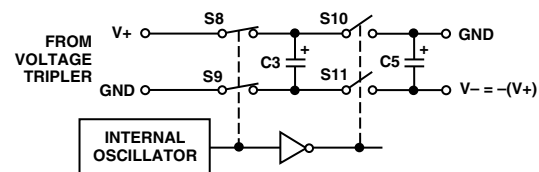

Figure 16. Charge Pump Voltage Inverter

The V+ and V- supplies may also be used to power external circuitry if the current requirements are small. Please refer to Figures 13 and 14 in the Typical Performance section.

GREEN IDLE

What Is Green Idle?

Green Idle is a method of minimizing power consumption under idle (no transmit) conditions while still maintaining the ability to instantly transmit data.

How Does it Work?

Charge pump type dc-dc converters used in RS-232 line drivers normally operate open-loop, i.e., the output voltage is not regulated in any way. Under light load conditions the output voltage is close to twice the supply voltage for a doubler and three times the supply voltage for a tripler, with very little ripple. As the load current increases, the output voltage falls and the ripple voltage increases.

Even under no-load conditions, the oscillator and charge pump are operating at a very high frequency with consequent switching losses and current drain.

Green Idle works by monitoring the output voltage and maintaining it at a constant value around 7 V. When the voltage rises above 7.25 V, the oscillator is turned off. When the supply voltage falls below 7.00 V, the oscillator is turned on and a burst of charging pulses is sent to the reservoir capacitor. When the oscillator is turned off the power consumption of the charge pump is virtually zero, so the average current drain under light load conditions is greatly reduced.

A block diagram of the Green Idle circuit is shown in Figure 17. Both V+ and V- are monitored and compared to a reference voltage derived from an on-chip bandgap device. If either V+ or V- fall below 7 V, the oscillator will start up until the voltage rises above 7.25 V.

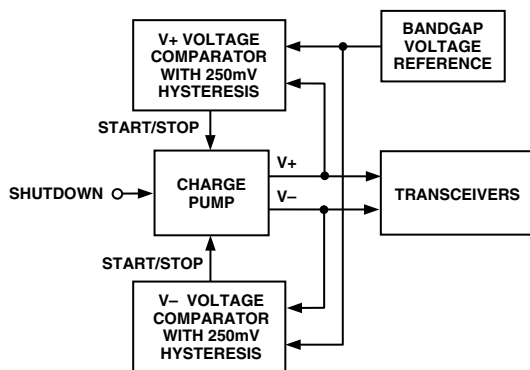

Figure 17. Block Diagram of Green Idle Circuit

The operation of Green Idle for V+ under various load conditions is illustrated in Figure 18. Under light load conditions, C1 is maintained in a charged condition and only a single oscillator pulse will be required to charge up C2. Under these conditions V+ may actually overshoot 7.25 V slightly.

Under medium load conditions it may take several cycles for C2 to charge up to 7.25 V. The average frequency of the oscillator will be higher because there are more pulses in each burst and the bursts of pulses are closer and more frequent.

Under high load conditions, the oscillator will be on continuously if the charge pump output cannot reach 7.25 V.

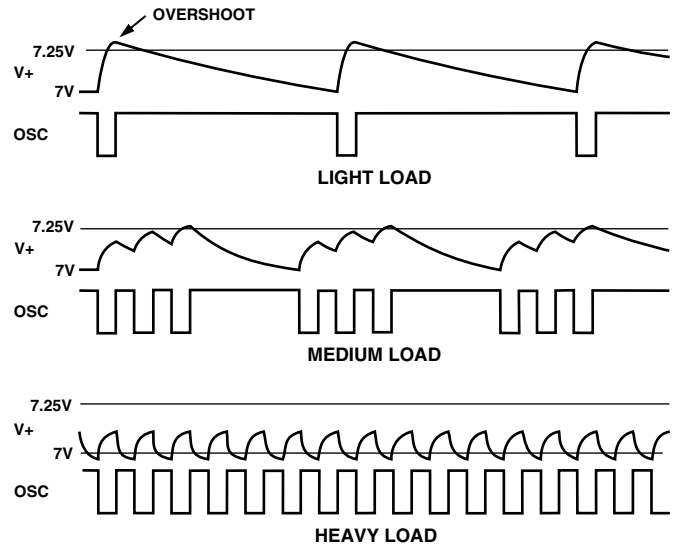

Figure 18. Operation of Green Idle Under Various Load Conditions

Green Idle vs. Shutdown

Shutdown mode minimizes power consumption by shutting down the charge pump altogether. In this condition the switches in the voltage tripler are configured so that V+ is connected directly to V_{CC}. V- is zero because there is no charge pump operation to charge C5. This means there is a delay after coming out shutdown before V+ and V- achieve their normal operating voltages. Green Idle maintains the transmitter supply voltages under transmitter idle conditions, so this delay does not occur.

Doesn't It Increase Supply Voltage Ripple?

The ripple on the output voltage of a charge pump operating open-loop depends on three factors: the oscillator frequency, the value of the reservoir capacitor and the load current. The value of the reservoir capacitor is fixed. Increasing the oscillator frequency will decrease the ripple voltage; decreasing the oscillator frequency will increase it. Increasing the load current will increase the ripple voltage; decreasing the load current will decrease it. The ripple voltage at light loads will naturally be lower than that for high load currents.

Using Green Idle, the ripple voltage is determined by the high and low thresholds of the Green Idle circuit. These are nominally 7.00 V and 7.25 V, so the ripple will be 250 mV under most load conditions. With very light load conditions there may be some overshoot above 7.25 V, so the ripple will be slightly greater. Under heavy load conditions where the output never reaches 7.25 V, the Green Idle circuit will be inoperative and the ripple voltage will be determined by the load current, the same as in a normal charge pump.

What About Electromagnetic Compatibility?

Because Green Idle does not operate with a constant oscillator frequency, the frequency and spectrum of the oscillator signal will vary with load. Any radiated and conducted emissions will also vary accordingly. Like other Analog Devices RS-232 transceiver products, the ADM3311E features slew rate limiting and other techniques to minimize radiated and conducted emissions. The device is characterized for EMC under all load conditions, and is well within the requirements of EN55022/CISPR22.

ADM3311E

Transmitter (Driver) Section

The drivers convert 3.3 V logic input levels into EIA-232 output levels. With $V_{CC} = +3.0$ V and driving an EIA-232 load, the output voltage swing is typically ± 6.4 V.

Unused inputs may be left unconnected, as an internal 400 k Ω pull-up resistor pulls them high, forcing the outputs into a low state. The input pull-up resistors typically source 8 μ A when grounded, so unused inputs should either be connected to V_{CC} or left unconnected in order to minimize power consumption.

Receiver Section

The receivers are inverting level-shifters that accept RS-232 input levels and translate them into 3 V logic output levels. The inputs have internal 5 k Ω pull-down resistors to ground and are also protected against overvoltages of up to ± 30 V. Unconnected inputs are pulled to 0 V by the internal 5 k Ω pull-down resistor. This, therefore, results in a Logic 1 output level for unconnected inputs or for inputs connected to GND.

The receivers have Schmitt trigger inputs with a hysteresis level of 0.4 V. This ensures error-free reception for both noisy inputs and for inputs with slow transition times.

ENABLE AND SHUTDOWN

The enable function is intended to facilitate data bus connections where it is desirable to three-state the receiver outputs. In the disabled mode, all receiver outputs are placed in a high impedance state. The shutdown function is intended to shut the device down, thereby minimizing the quiescent current. In shutdown, all transmitters are disabled as are receivers R1 to R4.

Receiver R5 remains enabled in shutdown. Note that disabled transmitters are not three-stated in shutdown, so it is not permitted to connect multiple (RS-232) driver outputs together.

The shutdown feature is very useful in battery operated systems since it reduces the power consumption to 0.06 μ W. During shutdown the charge pump is also disabled. When exiting shutdown, the charge pump is restarted and it takes approximately 100 μ s for it to reach its steady state operating condition.

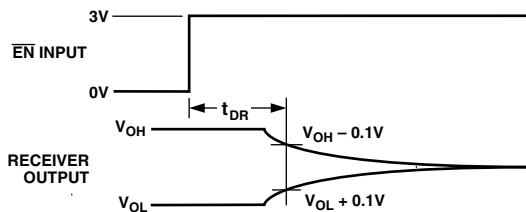

Figure 19. Receiver Disable Timing

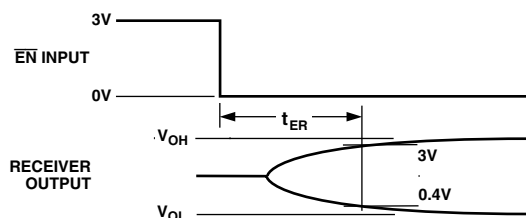

Figure 20. Receiver Enable Timing

HIGH BAUD RATE

The ADM3311E features high slew rates permitting data transmission at rates well in excess of the EIA/RS-232E specifications. RS-232 voltage levels are maintained at data rates up to 460 kbps. This allows for high speed data links between two terminals or indeed it is suitable for the new generation I_{SDN} modem standards which requires data rates of 230 kbps. The slew rate is internally controlled to less than 30 V/ μ s in order to minimize EMI interference.

LAYOUT AND SUPPLY DECOUPLING

Because of the high frequencies at which the ADM3311E oscillator operates, particular care should be taken with printed circuit board layout, with all traces being as short as possible and C1 to C5 being connected as close to the device as possible. The use of a ground plane under and around the device is highly recommended.

When the oscillator starts up during Green Idle operation, large current pulses are taken from V_{CC} . For this reason V_{CC} should be decoupled with a parallel combination of 1 μ F or greater tantalum and 0.1 μ F ceramic capacitor, mounted as close to the V_{CC} pin as possible.

Capacitors C1 to C5 can have values between 0.1 μ F and 1 μ F, larger values will give lower ripple. These capacitors can be either electrolytic capacitors chosen for low equivalent series resistance (ESR) or nonpolarized types, but the use of ceramic types is highly recommended. If polarized electrolytic capacitors are used, then polarity must be observed (as shown by C1+ for example).

ESD/EFT TRANSIENT PROTECTION SCHEME

The ADM3311E uses protective clamping structures on all inputs and outputs, which clamps the voltage to a safe level and dissipates the energy present in ESD (Electrostatic) and EFT (Electrical Fast Transients) discharges. A simplified schematic of the protection structure is shown below. Each input and output contains two back-to-back high speed clamping diodes. During normal operation with maximum RS-232 signal levels, the diodes have no effect as one or the other is reverse biased, depending on the polarity of the signal. If, however, the voltage exceeds about ± 50 V, reverse breakdown occurs and the voltage is clamped at this level. The diodes are large p-n junctions designed to handle the instantaneous current surge, which can exceed several amperes.

The transmitter outputs and receiver inputs have a similar protection structure. The receiver inputs can also dissipate some of the energy through the internal 5 k Ω resistor to GND as well as through the protection diodes.

The protection structure achieves ESD protection up to ± 15 kV and EFT protection up to ± 4 kV on all RS-232 I-O lines. The methods used to test the protection scheme are discussed later.

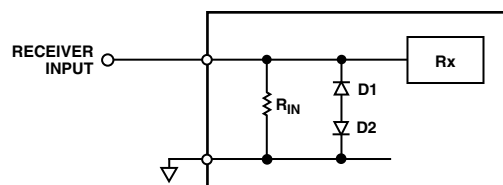

Figure 21a. Receiver Input Protection Scheme

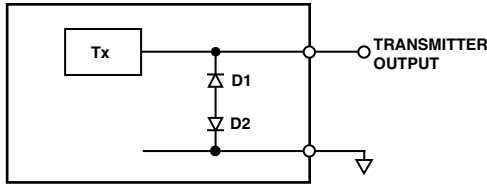

Figure 21b. Transmitter Output Protection Scheme

ESD TESTING (IEC1000-4-2)

IEC1000-4-2 (previously 801-2) specifies compliance testing using two coupling methods, contact discharge and air-gap discharge. Contact discharge calls for a direct connection to the unit being tested. Air-gap discharge uses a higher test voltage but does not make direct contact with the unit under test. With air discharge, the discharge gun is moved toward the unit under test, developing an arc across the air gap, hence the term air discharge. This method is influenced by humidity, temperature, barometric pressure, distance and rate of closure of the discharge gun. The contact-discharge method, while less realistic, is more repeatable and is gaining acceptance in preference to the air-gap method.

Although very little energy is contained within an ESD pulse, the extremely fast rise time coupled with high voltages can cause failures in unprotected semiconductors. Catastrophic destruction can occur immediately as a result of arcing or heating. Even if catastrophic failure does not occur immediately, the device may suffer from parametric degradation, which may result in degraded performance. The cumulative effects of continuous exposure can eventually lead to complete failure.

I-O lines are particularly vulnerable to ESD damage. Simply touching or plugging in an I-O cable can result in a static discharge that can damage or completely destroy the interface product connected to the I-O port. Traditional ESD test methods such as the MIL-STD-883B method 3015.7 do not fully test a product’s susceptibility to this type of discharge. This test was intended to test a product’s susceptibility to ESD damage during handling. Each pin is tested with respect to all other pins. There are some important differences between the traditional test and the IEC test:

- (a) The IEC test is much more stringent in terms of discharge energy. The peak current injected is over four times greater.
- (b) The current rise time is significantly faster in the IEC test.
- (c) The IEC test is carried out while power is applied to the device.

It is possible that the ESD discharge could induce latch-up in the device under test. This test is therefore more representative of a real-world I-O discharge where the equipment is operating normally with power applied. For maximum peace of mind however, both tests should be performed, thus ensuring maximum protection both during handling and later, during field service.

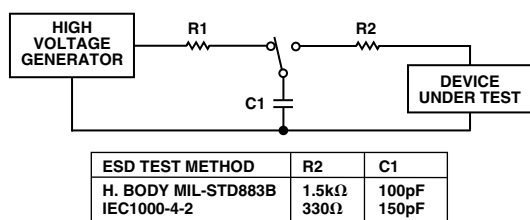

Figure 22. ESD Test Standards

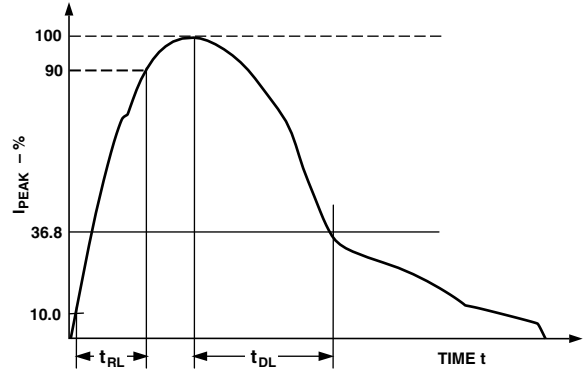

Figure 23. Human Body Model ESD Current Waveform

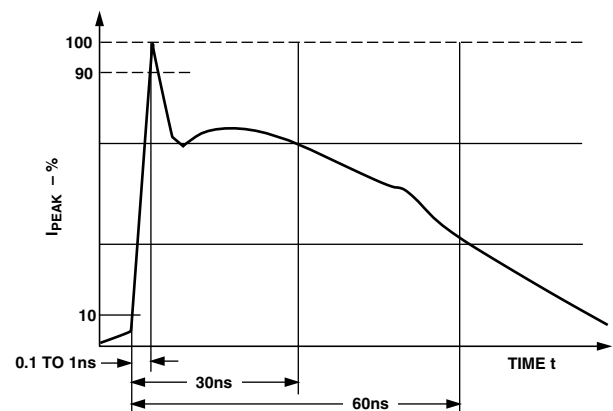

Figure 24. IEC1000-4-2 ESD Current Waveform

The ADM3311E is tested using both of the above-mentioned test methods. All pins are tested with respect to all other pins as per the MIL-STD-883B specification. In addition, all I-O pins are tested as per the IEC test specification. The products were tested under the following conditions:

- (a) Power-On—Normal Operation
- (b) Power-Off

Four levels of compliance are defined by IEC1000-4-2. The ADM3311E meets the most stringent compliance level for contact discharge. This means that the products are able to withstand contact discharges in excess of 8 kV.

Table II. IEC1000-4-2 Compliance Levels

Level	Contact Discharge (kV)	Air Discharge (kV)
1	2	2
2	4	4
3	6	8
4	8	15

Table III. ADM3311E ESD Test Results

ESD Test Method	I-O Pins (kV)	Other Pins (kV)
MIL-STD-883B	±15	±3
IEC1000-4-2 Contact	±8	

ADM3311E

FAST TRANSIENT BURST TESTING (IEC1000-4-4)

IEC1000-4-4 (previously 801-4) covers electrical fast-transient/burst (EFT) immunity. Electrical fast transients occur as a result of arcing contacts in switches and relays. The tests simulate the interference generated when, for example, a power relay disconnects an inductive load. A spark is generated due to the well known back EMF effect. In fact, the spark consists of a burst of sparks as the relay contacts separate. The voltage appearing on the line, therefore, consists of a burst of extremely fast transient impulses. A similar effect occurs when switching on fluorescent lights.

The fast transient burst test defined in IEC1000-4-4 simulates this arcing and its waveform is illustrated in Figure 25. It consists of a burst of 2.5 kHz to 5 kHz transients repeating at 300 ms intervals. It is specified for both power and data lines.

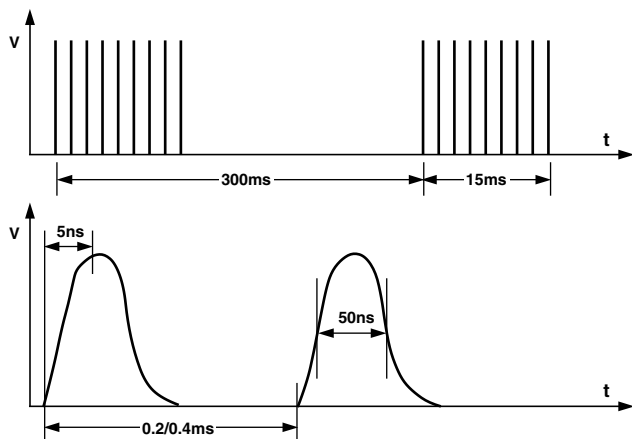

Figure 25. IEC1000-4-4 Fast Transient Waveform

Table IV.

Level	V Peak (kV) PSU	V Peak (kV) I-O
1	0.5	0.25
2	1	0.5
3	2	1
4	4	2

A simplified circuit diagram of the actual EFT generator is illustrated in Figure 26.

The transients are coupled onto the signal lines using an EFT coupling clamp. The clamp is 1 m long and it completely surrounds the cable, providing maximum coupling capacitance (50 pF to 200 pF typ) between the clamp and the cable. High energy transients are capacitively coupled onto the signal lines. Fast rise times (5 ns) as specified by the standard result in very effective coupling. This test is very severe since high voltages are coupled onto the signal lines. The repetitive transients can often cause problems where single pulses don't. Destructive latch-up may be induced due to the high energy content of the transients. Note that this stress is applied while the interface products are powered up and transmitting data. The EFT test applies hundreds of pulses with higher energy than ESD. Worst case transient current on an I-O line can be as high as 40 A.

Test results are classified according to the following:

1. Normal performance within specification limits.
2. Temporary degradation or loss of performance, which is self-recoverable.
3. Temporary degradation or loss of function or performance, which requires operator intervention or system reset.
4. Degradation or loss of function that is not recoverable due to damage.

The ADM3311E has been tested under worst case conditions using unshielded cables and meet Classification 2. Data transmission during the transient condition is corrupted but it may be resumed immediately following the EFT event without user intervention.

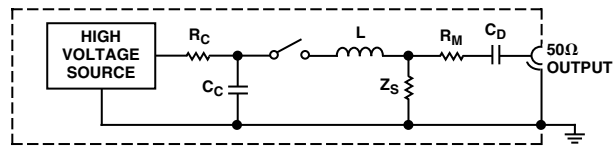

Figure 26. IEC1000-4-4 Fast Transient Generator

IEC1000-4-3 RADIATED IMMUNITY

IEC1000-4-3 (previously IEC801-3) describes the measurement method and defines the levels of immunity to radiated electromagnetic fields. It was originally intended to simulate the electromagnetic fields generated by portable radio transceivers or any other device that generates continuous wave radiated electromagnetic energy. Its scope has since been broadened to include spurious EM energy which can be radiated from fluorescent lights, thyristor drives, inductive loads, etc.

Testing for immunity involves irradiating the device with an EM field. There are various methods of achieving this including use of anechoic chamber, stripline cell, TEM cell, GTEM cell. A stripline cell consists of two parallel plates with an electric field developed between them. The device under test is placed within the cell and exposed to the electric field. There are three severity levels having field strengths ranging from 1 V to 10 V/m. Results are classified in a similar fashion to those for IEC1000-4-4.

1. Normal operation.
2. Temporary degradation or loss of function, which is self-recoverable when the interfering signal is removed.
3. Temporary degradation or loss of function that requires operator intervention or system reset when the interfering signal is removed.
4. Degradation or loss of function that is not recoverable due to damage.

The ADM3311E easily meets Classification 1 at the most stringent (Level 3) requirement. In fact, field strengths up to 30 V/m showed no performance degradation and error-free data transmission continued even during irradiation.

Table V. Test Severity Levels (IEC1000-4-3)

Level	Field Strength V/m
1	1
2	3
3	10

EMISSIONS/INTERFERENCE

EN55022, CISPR22 defines the permitted limits of radiated and conducted interference from Information Technology (IT) equipment. The objective of the standard is to minimize the level of emissions both conducted and radiated.

For ease of measurement and analysis, conducted emissions are assumed to predominate below 30 MHz and radiated emissions are assumed to predominate above 30 MHz.

CONDUCTED EMISSIONS

This is a measure of noise that is conducted onto the line power supply. Switching transients from the charge pump, which are 20 V in magnitude and contain significant energy, can lead to conducted emissions. Other sources of conducted emissions can be due to overlap in switch on times in the charge pump voltage converter. In the voltage tripler shown in Figure 27, if S2 has not fully turned off before S4 turns on, this results in a transient current glitch between V_{CC} and GND which results in conducted emissions. It is therefore important that the switches in the charge pump guarantee break-before-make switching under all conditions so that instantaneous short circuit conditions do not occur.

The ADM3311E has been designed to minimize the switching transients and ensure break-before-make switching thereby minimizing conducted emissions. This has resulted in the level of emissions being well below the limits required by the specification. No additional filtering/decoupling other than the recommended 0.1 μF capacitor is required.

Conducted emissions are measured by monitoring the line power supply. The equipment used consists of a LISN (Line Impedance Stabilizing Network) which essentially presents a fixed impedance at RF, and a spectrum analyzer. The spectrum analyzer scans for emissions up to 30 MHz and a plot for the ADM3311E is shown in Figure 28.

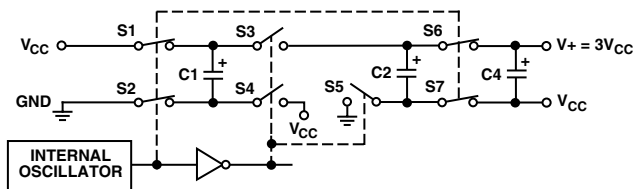

Figure 27. Charge Pump Voltage Tripler

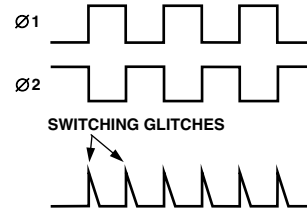

Figure 28. Switching Glitches

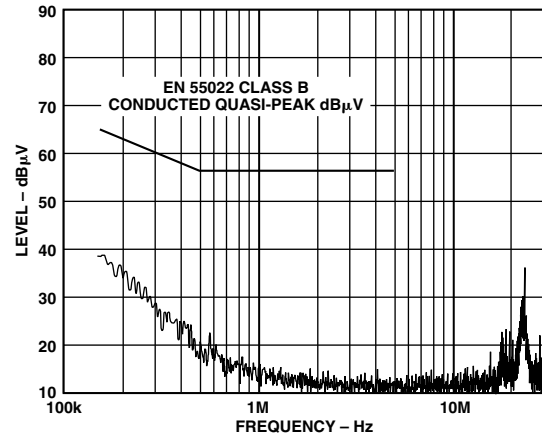

Figure 29. Conducted Emissions Plot

RADIATED EMISSIONS

Radiated emissions are measured at frequencies in excess of 30 MHz. RS-232 outputs designed for operation at high baud rates while driving cables can radiate high frequency EM energy. The reasons already discussed which cause conducted emissions can also be responsible for radiated emissions. Fast RS-232 output transitions can radiate interference, especially when lightly loaded and driving unshielded cables. Charge pump devices are also prone to radiating noise due to the high frequency oscillator and high voltages being switched by the charge pump. The move toward smaller capacitors in order to conserve board space has resulted in higher frequency oscillators being employed in the charge pump design. This has resulted in higher levels of emission, both conducted and radiated.

The RS-232 outputs on the ADM3311E products feature a controlled slew rate in order to minimize the level of radiated emissions, yet are fast enough to support data rates up to 230 kbaud.

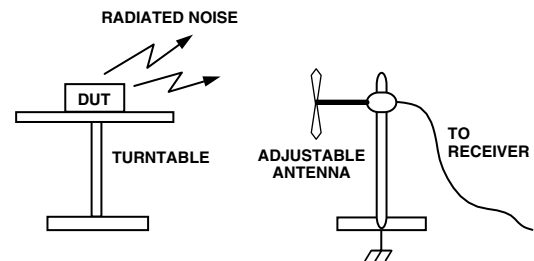

Figure 30. Radiated Emissions Test Setup

ADM3311E

Figure 31 shows a plot of radiated emissions vs. frequency. This shows that the levels of emissions are well within specifications without the need for any additional shielding or filtering components. The ADM3311E was operated at maximum baud rates and configured as in a typical RS-232 interface.

Testing for radiated emissions was carried out in a shielded anechoic chamber.

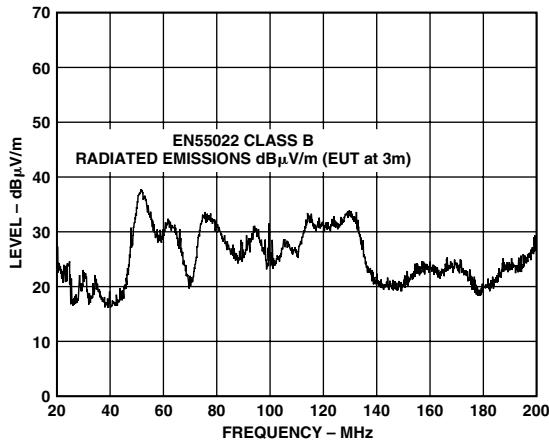
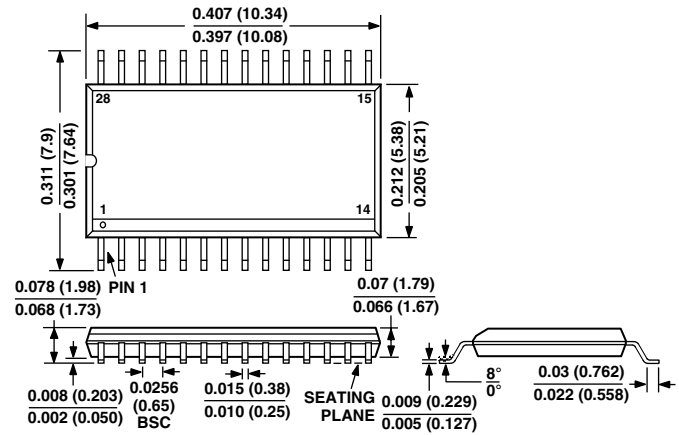

Figure 31. Radiated Emissions Plot

OUTLINE DIMENSIONS

Dimensions shown in inches and (mm).

28-Lead SSOP (RS-28)



28-Lead TSSOP (RU-28)

