

N-CHANNEL MOS FIELD EFFECT POWER TRANSISTOR

2SK699

DESCRIPTION The 2SK699 is N-Channel MOS Field Effect Power Transistor designed for solenoid, motor and lamp driver.

- FEATURES**
- 4 V Gate Drive — Logic level —
 - Low $R_{DS(on)}$
 - No Second Breakdown

ABSOLUTE MAXIMUM RATINGS

- Maximum Temperatures**
 Storage Temperature -55 to +150 °C
 Junction Temperature 150 °C Maximum
- Maximum Power Dissipations**
 Total Power Dissipation 1.3 W
 Total Power Dissipation ($T_C = 25\text{ °C}$) 15 W
- Maximum Voltages and Currents ($T_A = 25\text{ °C}$)**
 V_{DSS} Drain to Source Voltage 100 V
 V_{GSS} Gate to Source Voltage ±20 V
 $I_{D(DC)}$ Drain Current (DC) ±2 A
 $I_{D(pulse)}$ Drain Current (pulse)* ±6 A
- * $PW \leq 300\ \mu s$, Duty Cycle $\leq 10\%$

PACKAGE DIMENSIONS
in millimeters (inches)

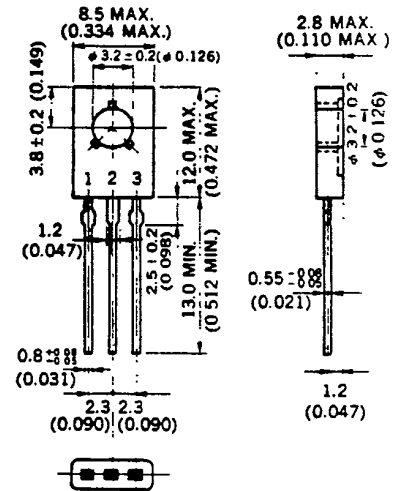

1. Source
2. Drain connected to mounting plane
3. Gate

ELECTRICAL CHARACTERISTICS ($T_A = 25\text{ °C}$)

SYMBOL	CHARACTERISTIC	MIN.	TYP.	MAX	UNIT	TEST CONDITIONS
$R_{DS(on)}$	Drain to Source On-State Resistance		0.8	1.2	Ω	$V_{GS} = 10\text{ V}$, $I_D = 1\text{ A}$
$r_{DS(on)}$	Drain to Source On-State Resistance		1.0	1.5	Ω	$V_{GS} = 4\text{ V}$, $I_D = 1\text{ A}$
$V_{GS(off)}$	Gate to Source Cutoff Voltage	1.0		2.5	V	$V_{DS} = 10\text{ V}$, $I_D = 1\text{ mA}$
Y_{fs}	Forward Transfer Admittance	0.5			S	$V_{DS} = 10\text{ V}$, $I_D = 1\text{ A}$
I_{DSS}	Drain Leakage Current			10	μA	$V_{DS} = 100\text{ V}$, $V_{GS} = 0$
I_{GSS}	Gate to Source Leakage Current			±100	nA	$V_{GS} = \pm 20\text{ V}$, $V_{DS} = 0$
C_{iss}	Input Capacitance		200		pF	$V_{DS} = 10\text{ V}$
C_{oss}	Output Capacitance		70		pF	$V_{GS} = 0$
C_{rss}	Reverse Transfer Capacitance		15		pF	$f = 1\text{ MHz}$
$t_{d(on)}$	Turn-On Delay Time		45		ns	$I_D = 1\text{ A}$, $V_{CC} = 50\text{ V}$ $R_L = 50\ \Omega$ $R_{in} = 10\ \Omega$
t_r	Rise Time		40		ns	
$t_{d(off)}$	Turn-Off Delay Time		450		ns	
t_f	Fall Time		110		ns	

NEC cannot assume any responsibility for any circuits shown or represent that they are free from patent infringement

2SK699

TYPICAL CHARACTERISTICS ($T_a = 25^\circ\text{C}$)

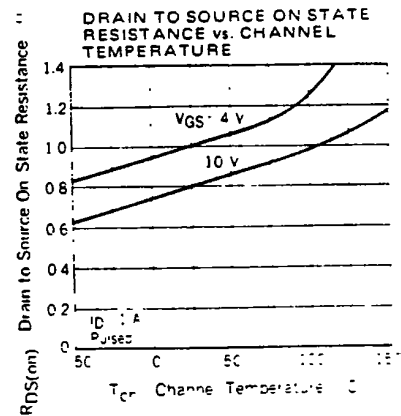
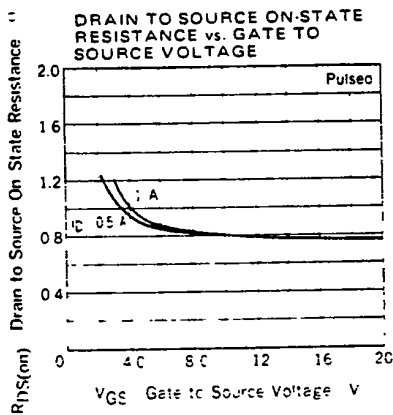
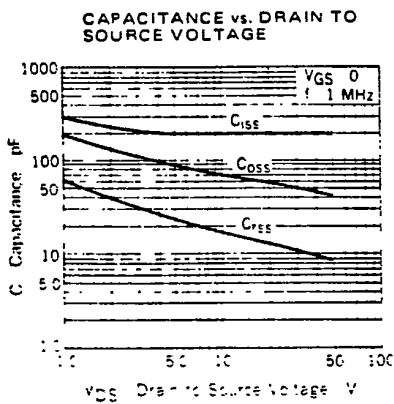
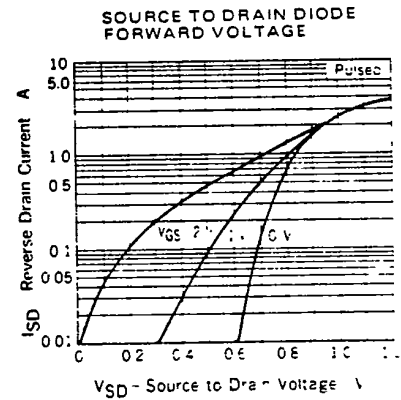
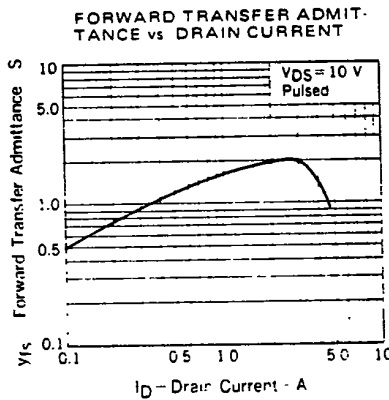
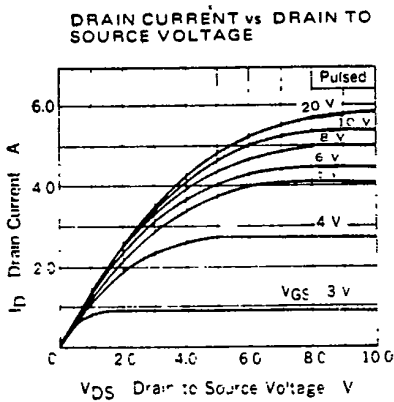
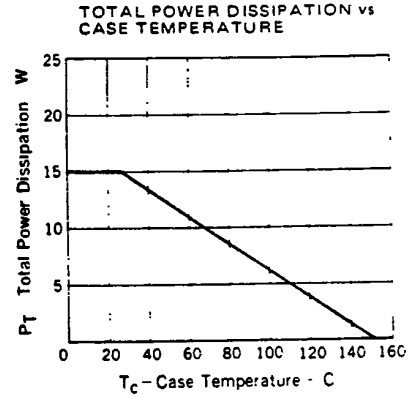
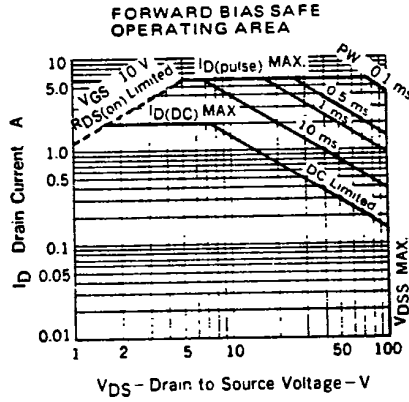
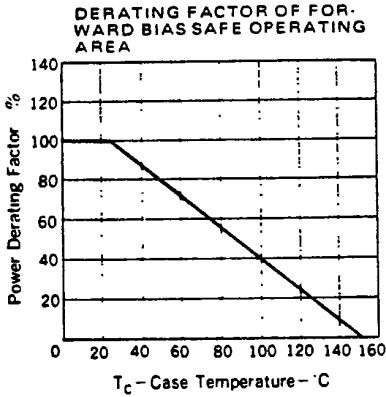

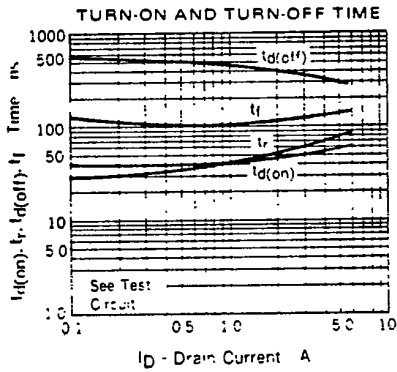
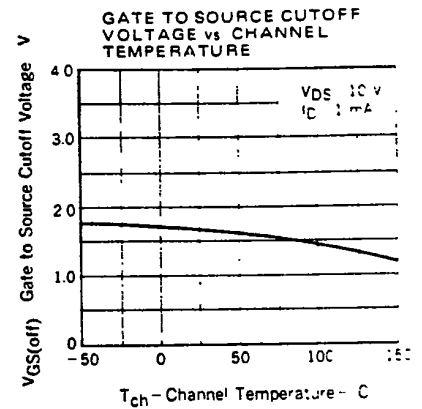
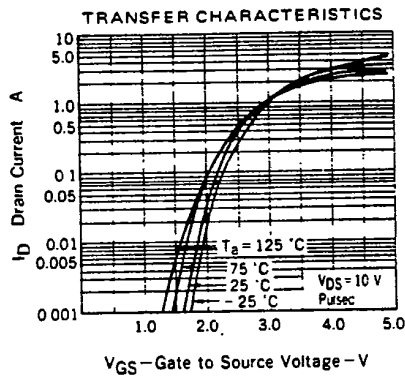
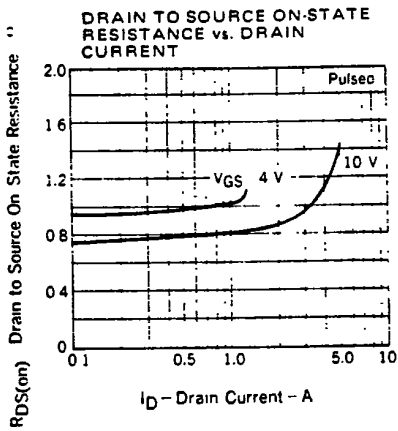

TURN-ON AND TURN-OFF TIME TEST CIRCUIT

