

MOS FIELD EFFECT POWER TRANSISTORS

2SJ494

SWITCHING P-CHANNEL POWER MOS FET INDUSTRIAL USE

DESCRIPTION

This product is P-Channel MOS Field Effect Transistor designed for high current switching applications.

FEATURES

- Super Low On-State Resistance
 $R_{DS(on)1} = 50 \text{ m}\Omega \text{ Max. (} V_{GS} = -10 \text{ V, } I_D = -10 \text{ A)}$
 $R_{DS(on)2} = 88 \text{ m}\Omega \text{ Max. (} V_{GS} = -4 \text{ V, } I_D = -10 \text{ A)}$
- Low C_{iss} $C_{iss} = 2360 \text{ pF Typ.}$
- Built-in Gate Protection Diode

ABSOLUTE MAXIMUM RATINGS ($T_A = 25^\circ\text{C}$)

Drain to Source Voltage	V_{DSS}	-60	V
Gate to Source Voltage*	$V_{GSS(AC)}$	± 20	V
Gate to Source Voltage	$V_{GSS(DC)}$	-20, 0	V
Drain Current (DC)	$I_D(DC)$	± 20	A
Drain Current (pulse)**	$I_D(pulse)$	± 80	A
Total Power Dissipation ($T_C = 25^\circ\text{C}$)	P_T	35	W
Total Power Dissipation ($T_A = 25^\circ\text{C}$)	P_T	2.0	W
Channel Temperature	T_{ch}	150	$^\circ\text{C}$
Storage Temperature	T_{stg}	-55 to +150	$^\circ\text{C}$

* $f = 20 \text{ kHz}$, Duty Cycle $\leq 10\%$ (+Side)

** $PW \leq 10 \mu\text{s}$, Duty Cycle $\leq 1\%$

THERMAL RESISTANCE

Channel to Case	$R_{th(ch-C)}$	3.57 $^\circ\text{C/W}$
Channel to Ambient	$R_{th(ch-A)}$	62.5 $^\circ\text{C/W}$

The diode connected between the gate and source of the transistor serves as a protector against ESD. When this device actually used, an additional protection circuit is externally required if a voltage exceeding the rated voltage may be applied to this device.

PACKAGE DIMENSIONS (in millimeter)

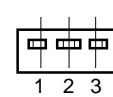
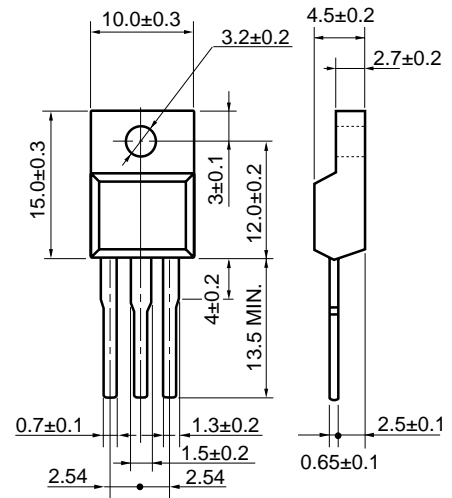

1. Gate
2. Drain
3. Source

ISOLATED TO-220 (MP-45F)

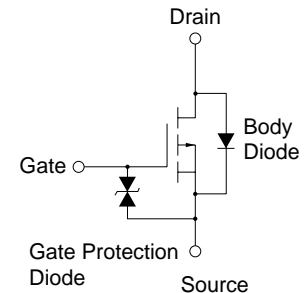

ELECTRICAL CHARACTERISTICS (T_A = 25 °C)

CHARACTERISTICS	SYMBOL	TEST CONDITIONS	MIN.	TYP.	MAX.	UNIT
Drain to Source On-state Resistance	R _{DS(on)1}	V _{GS} = -10 V, I _D = -10 A		39	50	mΩ
	R _{DS(on)2}	V _{GS} = -4 V, I _D = -10 A		61	88	mΩ
Gate to Source Cutoff Voltage	V _{GS(off)}	V _{DS} = -10 V, I _D = -1 mA	-1.0	-1.5	-2.0	V
Forward Transfer Admittance	y _{fs}	V _{DS} = -10 V, I _D = -10 A	8.0	15		S
Drain Leakage Current	I _{DSS}	V _{DS} = -60 V, V _{GS} = 0			-10	μA
Gate to Source Leakage Current	I _{GSS}	V _{GS} = ±20 V, V _{DS} = 0			±10	μA
Input Capacitance	C _{iss}	V _{DS} = -10 V V _{GS} = 0 f = 1 MHz		2360		pF
Output Capacitance	C _{oss}			1060		pF
Reverse Transfer Capacitance	C _{rss}			350		pF
Turn-On Delay Time	t _{d(on)}	I _D = -10 A V _{GS(on)} = -10 V V _{DD} = -30 V R _G = 10 Ω		25		ns
Rise Time	t _r			160		ns
Turn-Off Delay Time	t _{d(off)}			310		ns
Fall Time	t _f			240		ns
Total Gate Charge	Q _G	I _D = -20 A V _{DD} = -48 V V _{GS} = -10 V		74		nC
Gate to Source Charge	Q _{GS}			12		nC
Gate to Drain Charge	Q _{GD}			16		nC
Body Diode Forward Voltage	V _{F(S-D)}	I _F = 20 A, V _{GS} = 0		1.0	1.5	V
Reverse Recovery Time	t _{rr}	I _F = 20 A, V _{GS} = 0 di/dt = 100 A/μs		130		ns
Reverse Recovery Charge	Q _{rr}			290		nC

Test Circuit 1 Switching Time

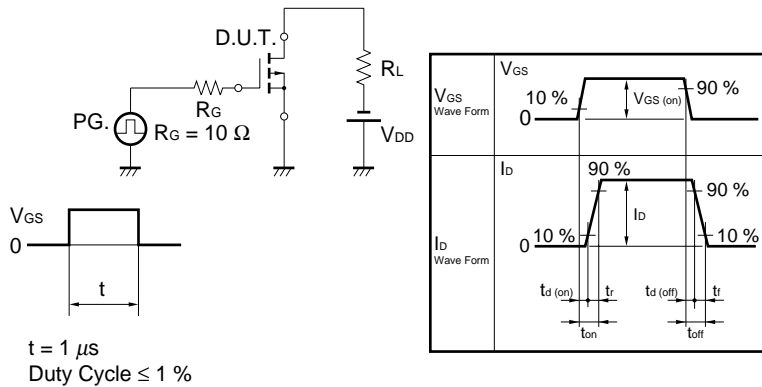

Test Circuit 2 Gate Charge

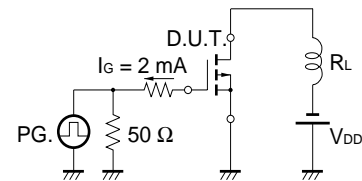

DERATING FACTOR OF FORWARD BIAS SAFE OPERATING AREA

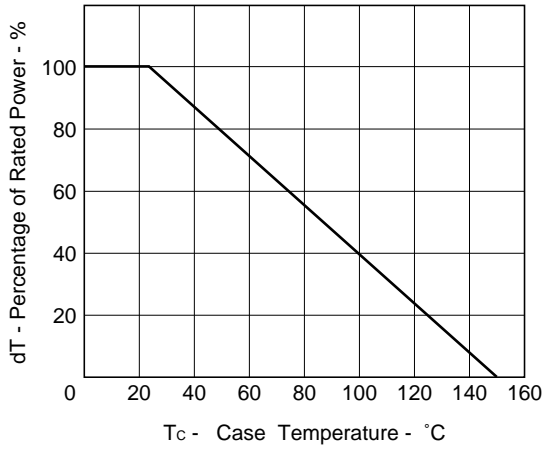

TOTAL POWER DISSIPATION vs. CASE TEMPERATURE

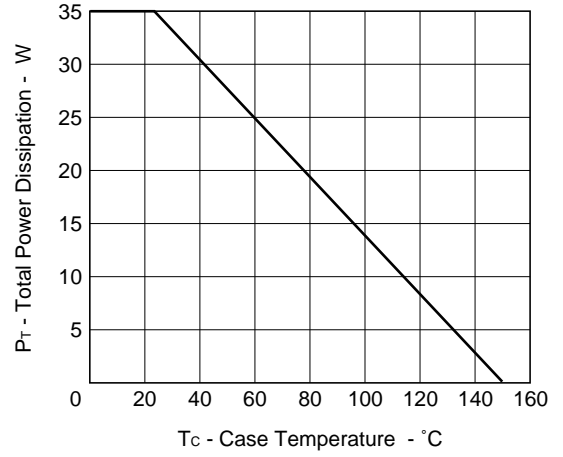

FORWARD BIAS SAFE OPERATING AREA

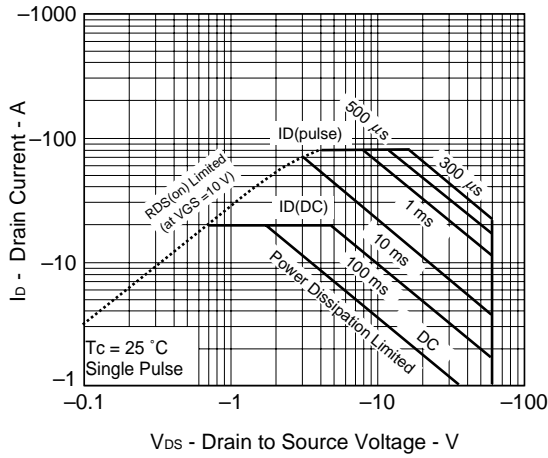

DRAIN CURRENT vs. DRAIN TO SOURCE VOLTAGE

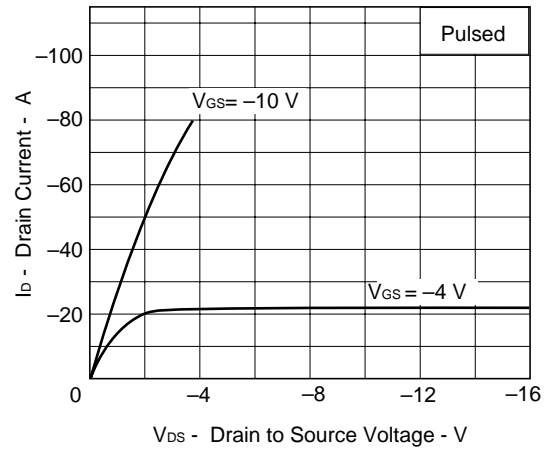

FORWARD TRANSFER CHARACTERISTICS

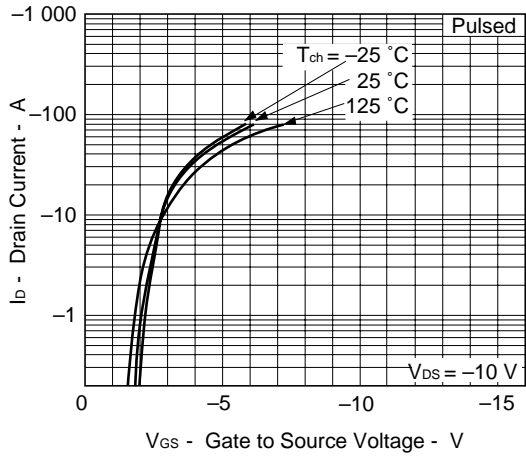

TRANSIENT THERMAL RESISTANCE vs. PULSE WIDTH

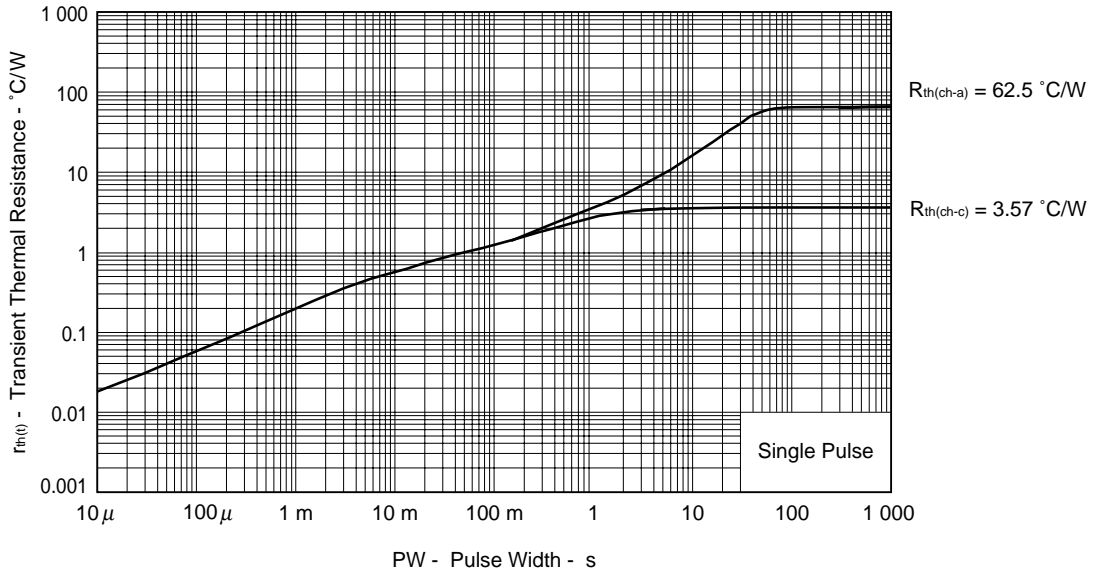

FORWARD TRANSFER ADMITTANCE vs. DRAIN CURRENT

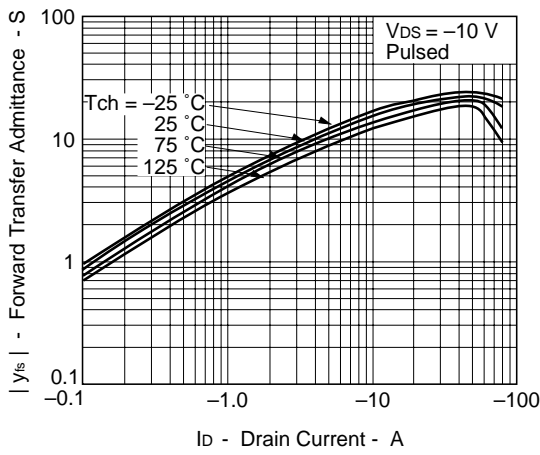

DRAIN TO SOURCE ON-STATE RESISTANCE vs. GATE TO SOURCE VOLTAGE

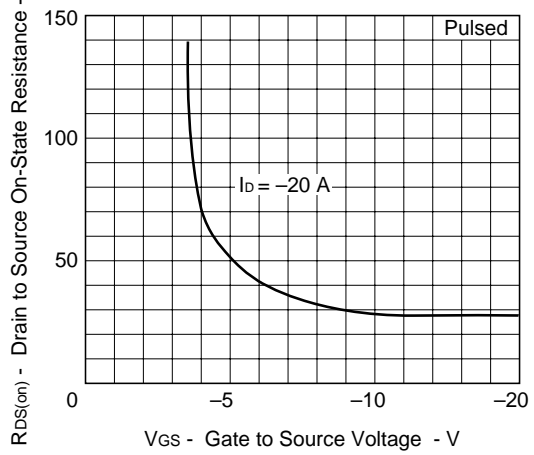

DRAIN TO SOURCE ON-STATE RESISTANCE vs. DRAIN CURRENT

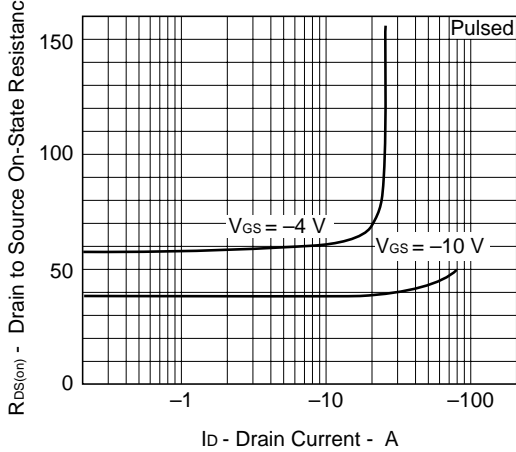

GATE TO SOURCE CUTOFF VOLTAGE vs. CHANNEL TEMPERATURE

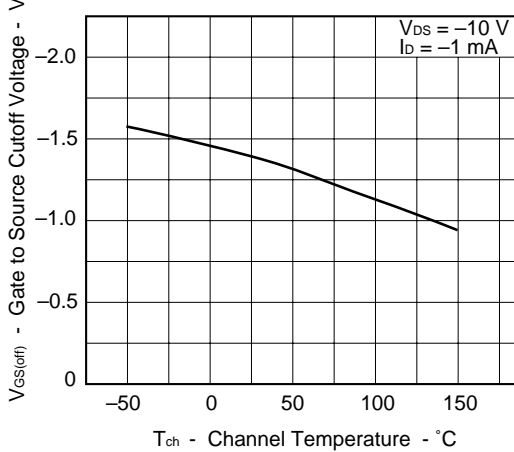

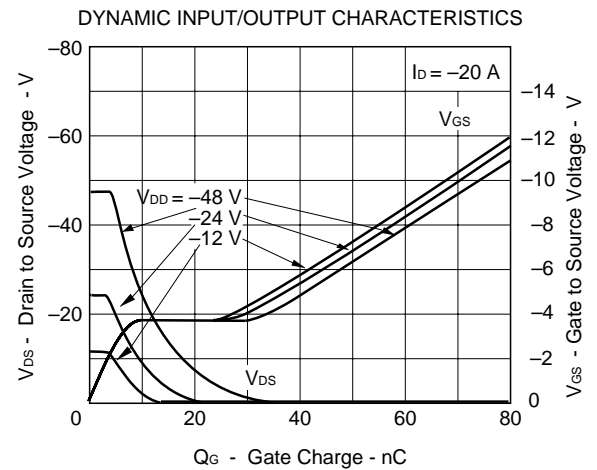
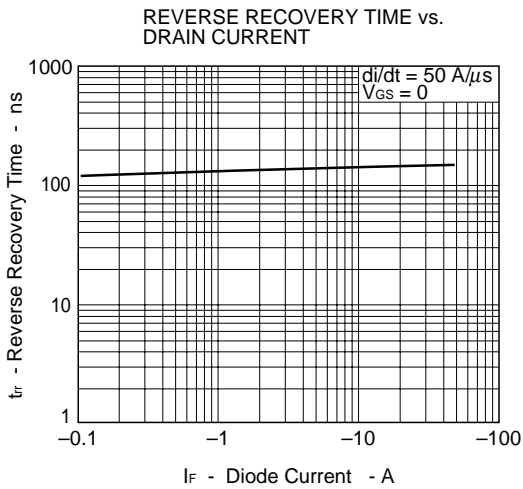
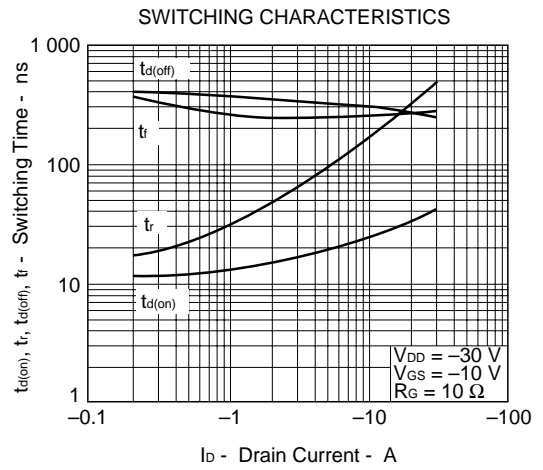
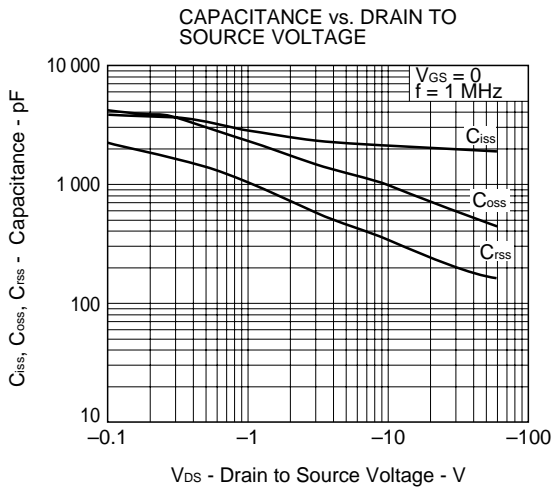
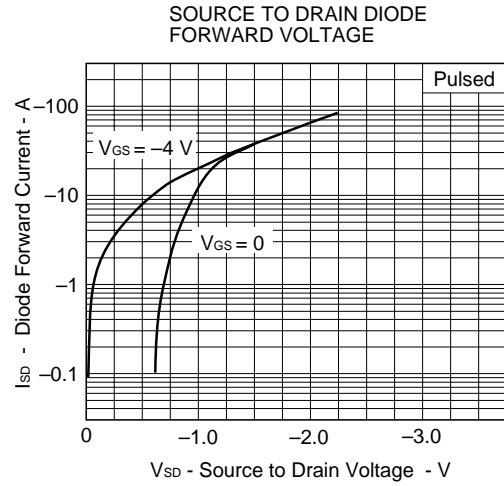
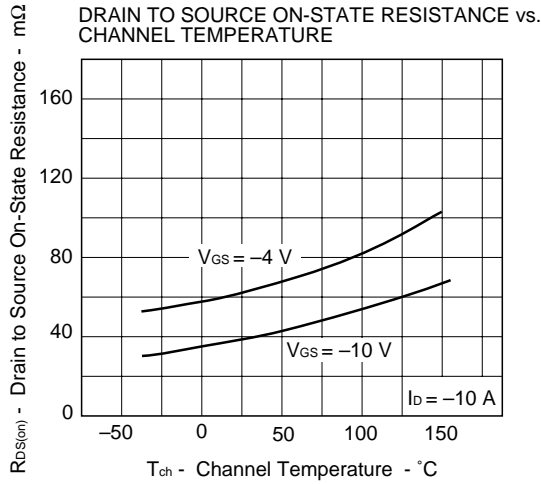

Document Name	Document No.
NEC semiconductor device reliability/quality control system	C11745E
Power MOS FET features and application to switching power supply	D12971E
Application circuits using Power MOS FET	TEA-1035
Safe operating area of Power MOS FET	TEA-1037
Guide to prevent damage for semiconductor devices by electrostatic discharge (EDS)	C11892E

[MEMO]

No part of this document may be copied or reproduced in any form or by any means without the prior written consent of NEC Corporation. NEC Corporation assumes no responsibility for any errors which may appear in this document.

NEC Corporation does not assume any liability for infringement of patents, copyrights or other intellectual property rights of third parties by or arising from use of a device described herein or any other liability arising from use of such device. No license, either express, implied or otherwise, is granted under any patents, copyrights or other intellectual property rights of NEC Corporation or others.

While NEC Corporation has been making continuous effort to enhance the reliability of its semiconductor devices, the possibility of defects cannot be eliminated entirely. To minimize risks of damage or injury to persons or property arising from a defect in an NEC semiconductor device, customers must incorporate sufficient safety measures in its design, such as redundancy, fire-containment, and anti-failure features.

NEC devices are classified into the following three quality grades:

"Standard", "Special", and "Specific". The Specific quality grade applies only to devices developed based on a customer designated "quality assurance program" for a specific application. The recommended applications of a device depend on its quality grade, as indicated below. Customers must check the quality grade of each device before using it in a particular application.

Standard: Computers, office equipment, communications equipment, test and measurement equipment, audio and visual equipment, home electronic appliances, machine tools, personal electronic equipment and industrial robots

Special: Transportation equipment (automobiles, trains, ships, etc.), traffic control systems, anti-disaster systems, anti-crime systems, safety equipment and medical equipment (not specifically designed for life support)

Specific: Aircrafts, aerospace equipment, submersible repeaters, nuclear reactor control systems, life support systems or medical equipment for life support, etc.

The quality grade of NEC devices is "Standard" unless otherwise specified in NEC's Data Sheets or Data Books. If customers intend to use NEC devices for applications other than those specified for Standard quality grade, they should contact an NEC sales representative in advance.

Anti-radioactive design is not implemented in this product.