

SANYO	No.5267	<h1 style="margin: 0;">2SJ417</h1> <p style="margin: 0;">P-Channel Silicon MOSFET</p> <h2 style="margin: 0;">Ultrahigh-Speed Switching Applications</h2>
--------------	---------	--

Features

- Low ON-resistance.
- Ultrahigh-speed switching.
- 4V drive.

Absolute Maximum Ratings at Ta = 25°C

Drain-to-Source Voltage	V_{DSS}	-30	V	unit
Gate-to-Source Voltage	V_{GSS}	±20	V	
Drain Current(DC)	I_D	-4	A	
Drain Current(Pulse)	I_{DP}	-16	A	
Allowable Power Dissipation	P_D	1	W	
		$T_c = 25^\circ\text{C}$		
Channel Temperature	T_{ch}	20	W	
Storage Temperature	T_{stg}	150	°C	
		-55 to +150	°C	

Electrical Characteristics at Ta = 25°C

			min	typ	max	unit
D-S Breakdown Voltage	$V_{(BR)DSS}$	$I_D = -1\text{mA}, V_{GS} = 0$	-30			V
Zero-Gate Voltage Drain Current	I_{DSS}	$V_{DS} = -30\text{V}, V_{GS} = 0$			-100	μA
Gate-to-Source Leakage Current	I_{GSS}	$V_{GS} = \pm 16\text{V}, V_{DS} = 0$			±10	μA
Cutoff Voltage	$V_{GS(off)}$	$V_{DS} = -10\text{V}, I_D = -1\text{mA}$	-1.0		-2.5	V
Forward Transfer Admittance	$ Y_{fs} $	$V_{DS} = -10\text{V}, I_D = -2\text{A}$	2	4		S
Static Drain-to-Source ON-State Resistance	$R_{DS(on)}$	$I_D = -2\text{A}, V_{GS} = -10\text{V}$		120	160	mΩ
	$R_{DS(on)}$	$I_D = -2\text{A}, V_{GS} = -4\text{V}$		210	290	mΩ
Input Capacitance	C_{iss}	$V_{DS} = -10\text{V}, f = 1\text{MHz}$		370		pF
Output Capacitance	C_{oss}	$V_{DS} = -10\text{V}, f = 1\text{MHz}$		230		pF
Reverse Transfer Capacitance	C_{rss}	$V_{DS} = -10\text{V}, f = 1\text{MHz}$		70		pF
Turn-ON Delay Time	$t_{d(on)}$	See specified Test Circuit.		10		ns
Rise Time	t_r	"		50		ns
Turn-OFF Delay Time	$t_{d(off)}$	"		135		ns
Fall Time	t_f	"		125		ns
Diode Forward Voltage	V_{SD}	$I_S = -4\text{A}, V_{GS} = 0$	-1.0	-1.2		V

Marking : JJ

Switching Time Test Circuit

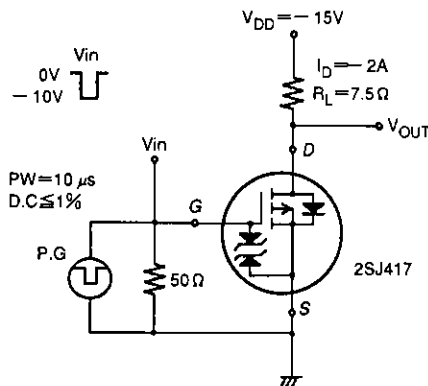

Package Dimensions 2083B

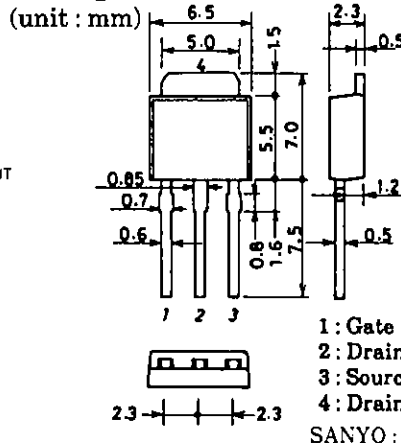

SANYO : TP

Package Dimensions 2092B

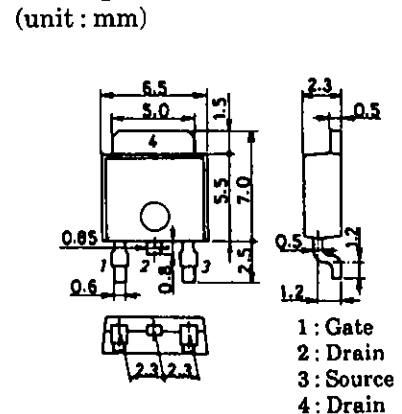

SANYO : TP-FA

SANYO Electric Co., Ltd. Semiconductor Business Headquarters
 TOKYO OFFICE Tokyo Bldg., 1-10, 1 Chome, Ueno, Taito-ku, TOKYO, 110 JAPAN

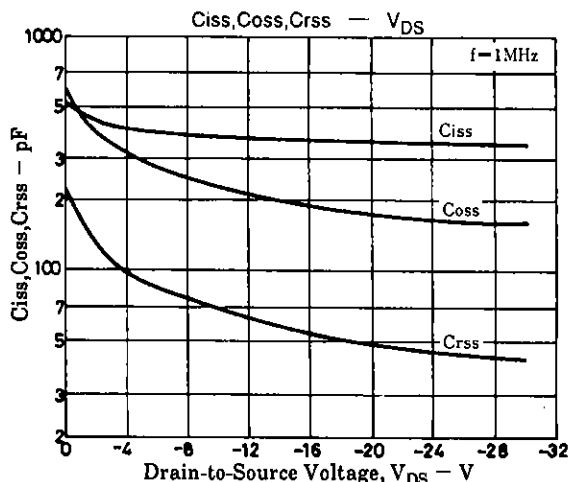
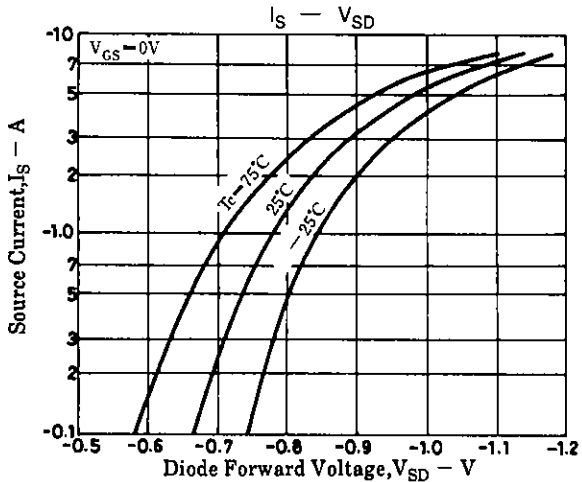
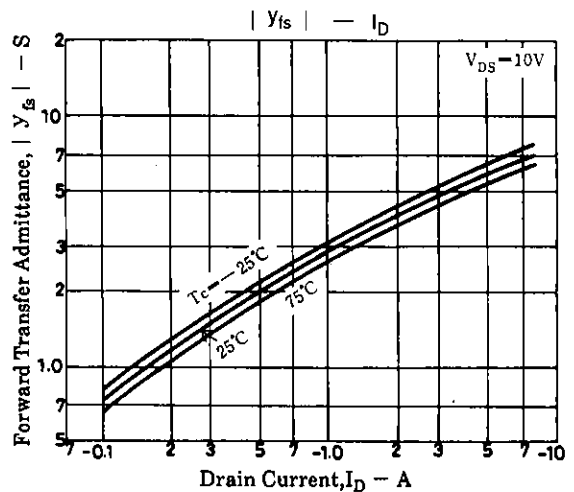
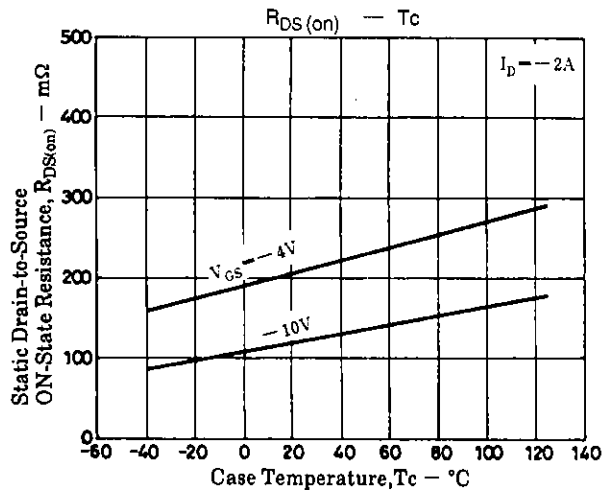
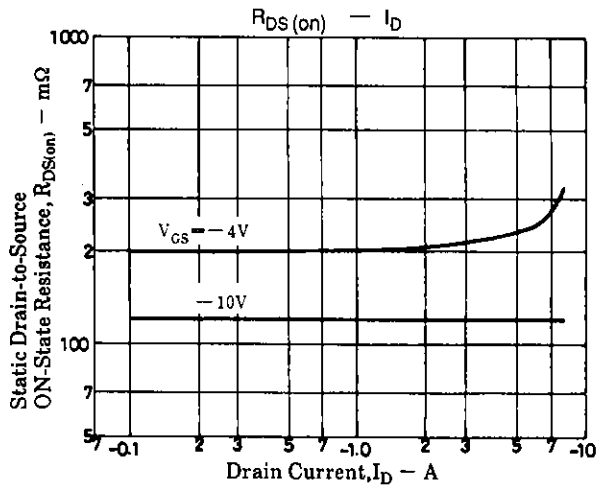
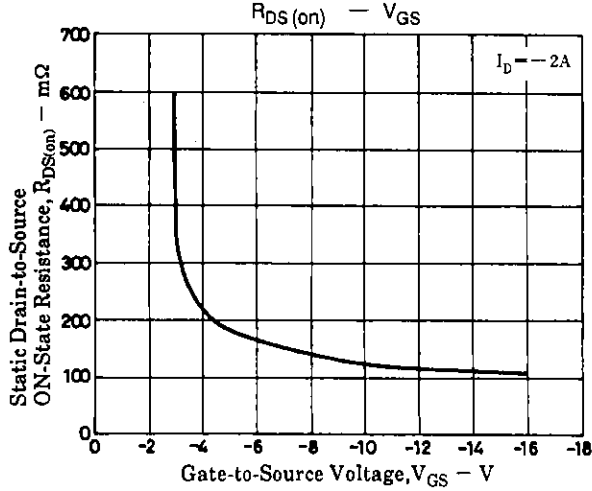
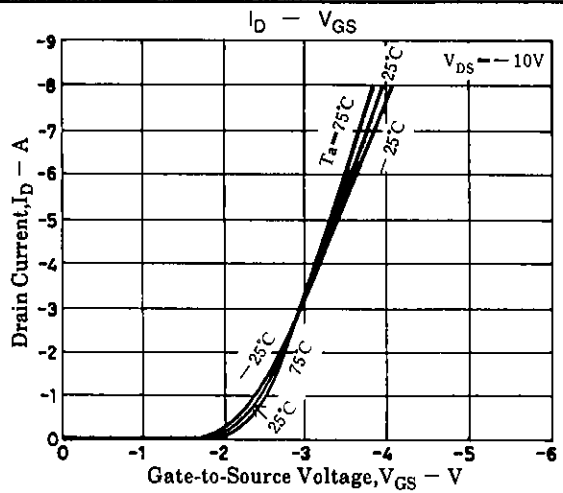
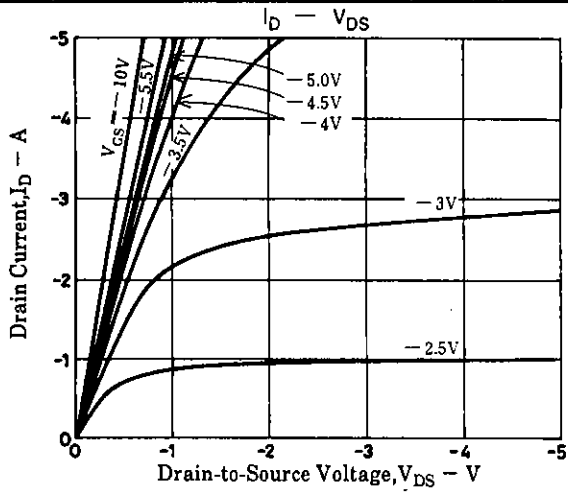

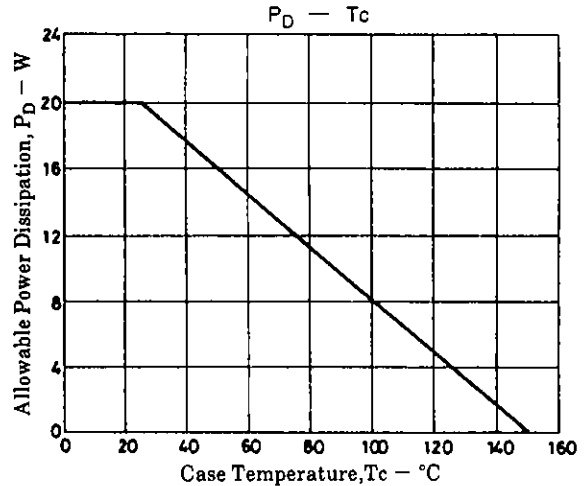
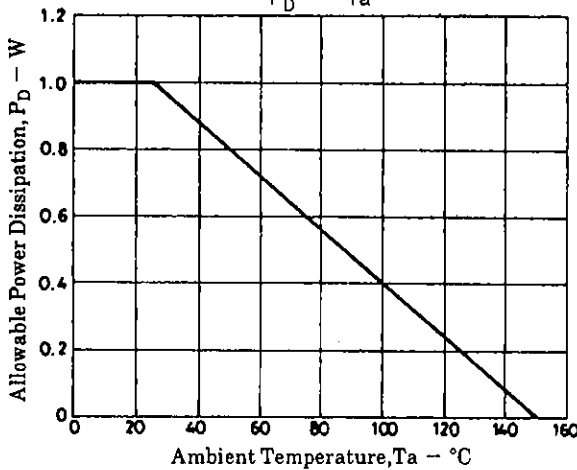
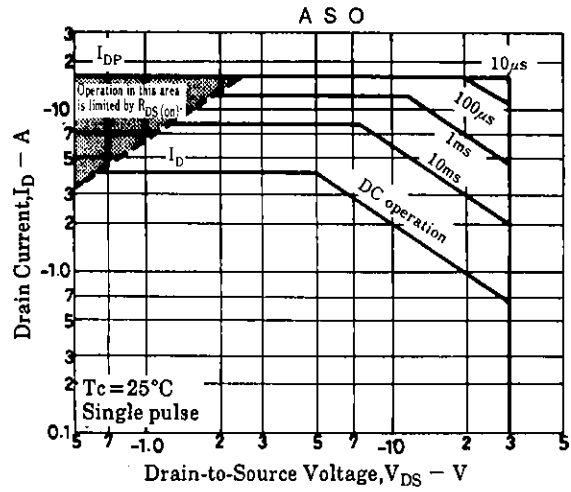
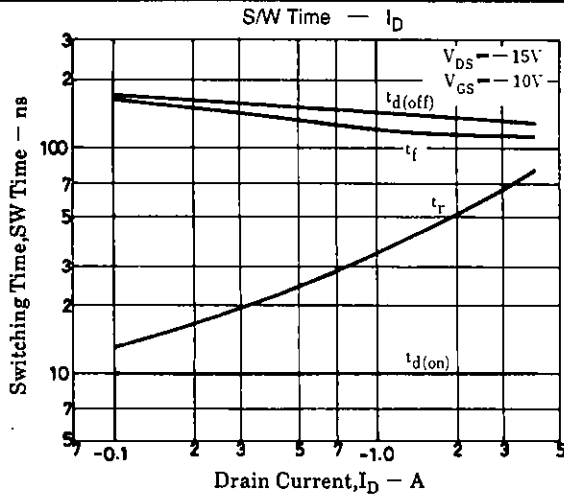

- No products described or contained herein are intended for use in surgical implants, life-support systems, aerospace equipment, nuclear power control systems, vehicles, disaster/crime-prevention equipment and the like, the failure of which may directly or indirectly cause injury, death or property loss.
- Anyone purchasing any products described or contained herein for an above-mentioned use shall:
 - ① Accept full responsibility and indemnify and defend SANYO ELECTRIC CO., LTD., its affiliates, subsidiaries and distributors and all their officers and employees, jointly and severally, against any and all claims and litigation and all damages, cost and expenses associated with such use;
 - ② Not impose any responsibility for any fault or negligence which may be cited in any such claim or litigation on SANYO ELECTRIC CO., LTD., its affiliates, subsidiaries and distributors or any of their officers and employees jointly or severally.
- Information (including circuit diagrams and circuit parameters) herein is for example only; it is not guaranteed for volume production. SANYO believes information herein is accurate and reliable, but no guarantees are made or implied regarding its use or any infringements of intellectual property rights or other rights of third parties.

This catalog provides information as of April, 1996. Specifications and information herein are subject to change without notice.