



MOS FIELD EFFECT TRANSISTOR

2SJ138

**FAST SWITCHING
P-CHANNEL SILICON POWER MOS FET**

PACKAGE DIMENSIONS

(Unit: mm)

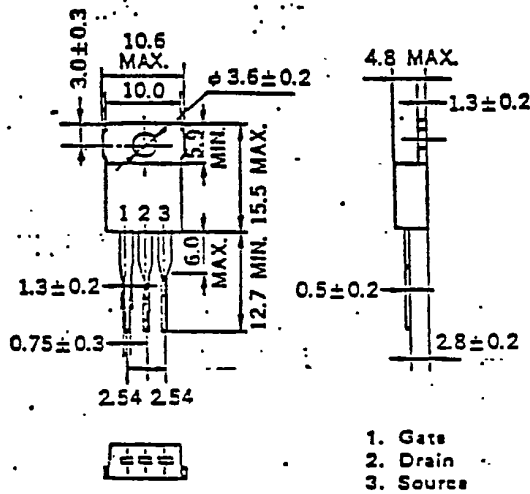

Features

- Suitable for switching power supplies, actuator controls and pulse circuits
- 4V Gate Drive — Logic Level —
- Large current switching : $I_D(DC)=12A$
- Low $R_{DS(on)}$
- No Secondary Breakdown

Absolute Maximum Ratings($T_a=25^\circ C$)

Drain to Source Voltage	V_{DS}	-100V
Gate to Source Voltage	V_{GS}	$\pm 20V$
Continuous Drain Current	$I_D(DC)$	$\pm 12A$
Pulse Drain Current	$I_D(pulse)$	* $\pm 48A$
Total Power Dissipation	PT	1.5W
Total Power Dissipation	PT**	60W
Channel Temperature	T_{ch}	150 °C
Storage Temperature	T_{stg}	-55to+150 °C

* $T_{ch} \leq 150^\circ C$
** $T_c=25^\circ C$

Electrical Characteristics ($T_a=25^\circ C$)

Characteristics	Symbol	Min.	Typ.	Max.	Unit	Test Conditions
Drain Leakage Current	I_{DSS}			- 10	μA	$V_{DS}=-100V, V_{GS}=0$
Gate to Source Leakage Current	I_{GSS}			100	nA	$V_{GS}=20V, V_{DS}=0$
Gate to Source Cutoff Voltage	$V_{GS(off)}$	-1.0		-3.0	V	$V_{DS}=-10V, I_D=-1.0mA$
Forward Transfer Admittance	$ y_{fs} $	2.0			S	$V_{DS}=-10V, I_D=-6.5A$
Drain to Source On-State Resistance	$R_{DS(on)}$			0.3	Ω	$V_{GS}=-10V, I_D=-6.5A$
Drain to Source On-State Resistance	$R_{DS(on)}$			0.45	Ω	$V_{GS}=-1.0V, I_D=-6.5A$
Input Capacitance	C_{iss}		2700		pF	$V_{DS}=-10V, V_{GS}=0$
Output Capacitance	C_{oss}		600		pF	$V_{GS}=0, V_{DS}=-10V$
Reverse Transfer Capacitance	C_{rss}		110		pF	$f=1.0MHz$
Turn-On Delay Time	$t_d(on)$		15		ns	$I_D=-6.5A, V_{GS}(on)=-10V$
Rise Time	t_r		70		ns	$V_{GS}(on)=-10V$
Turn-Off Delay Time	$t_d(off)$		85		ns	$V_{GS}=-50V$
Fall Time	t_f		70		ns	$R_L=8\Omega$

TURN-ON AND TURN-OFF TIME TEST CIRCUIT

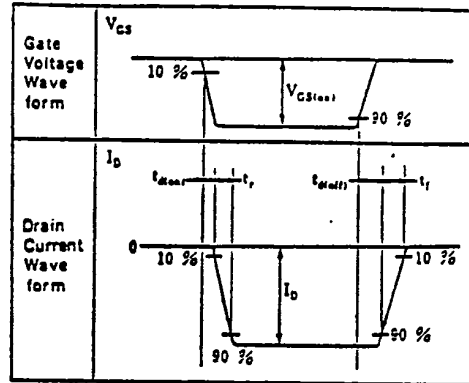
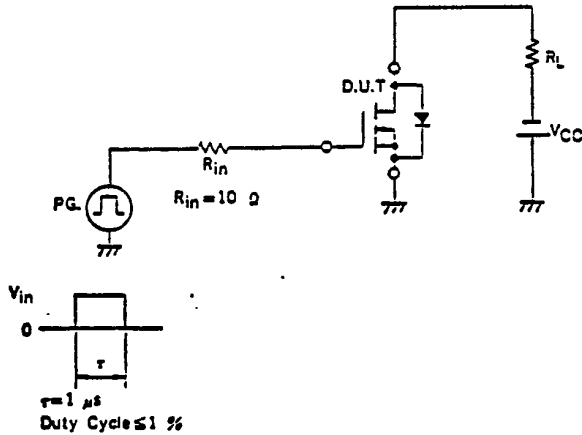

DERATING FACTOR OF FORWARD BIAS SAFE OPERATING AREA

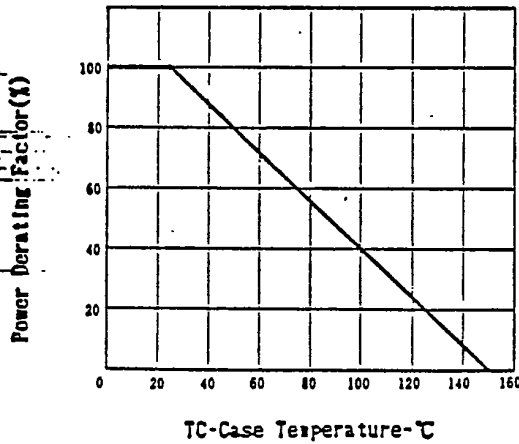

FORWARD BIAS SAFE OPERATING AREA

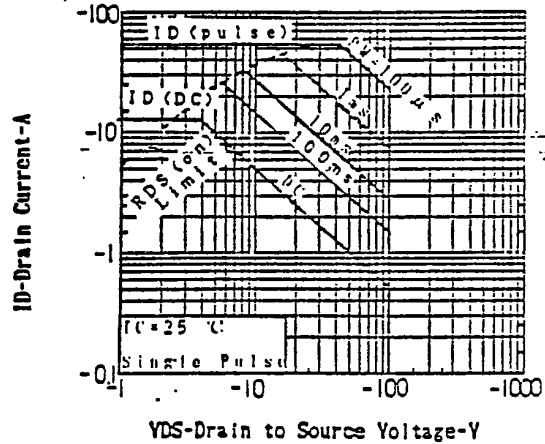

TOTAL POWER DISSIPATION vs. CASE TEMPERATURE

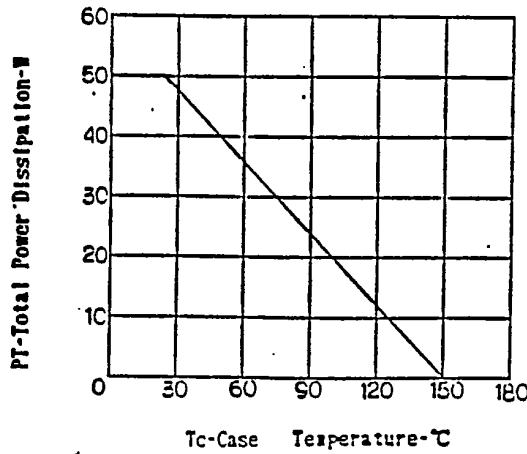

DRAIN CURRENT vs. DRAIN TO SOURCE VOLTAGE

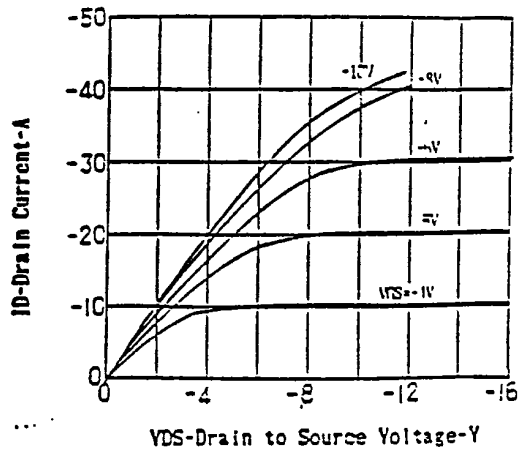

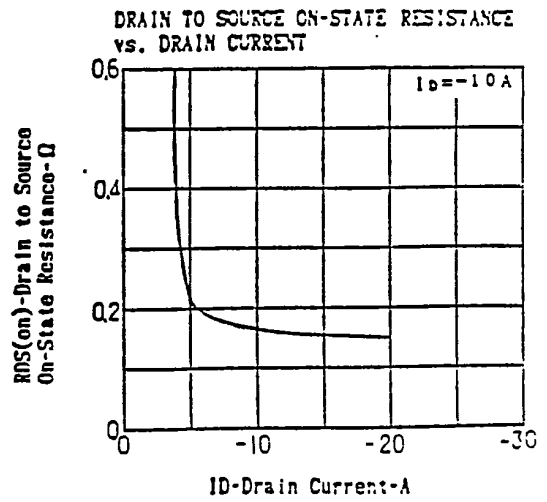
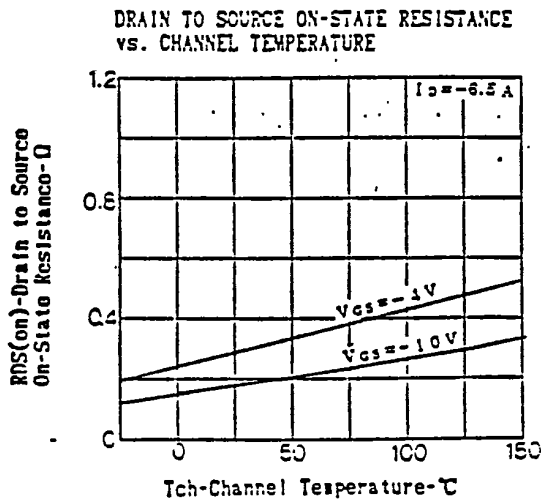
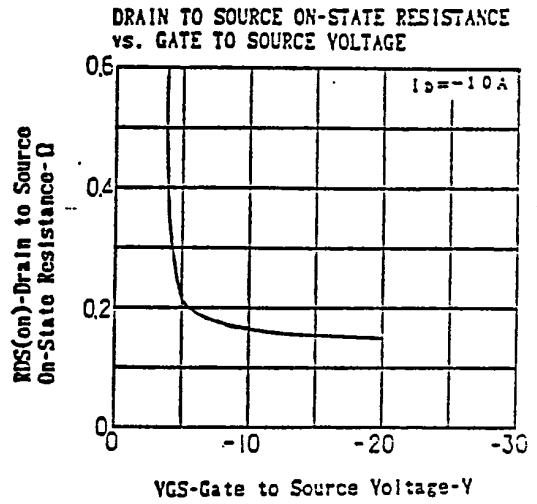
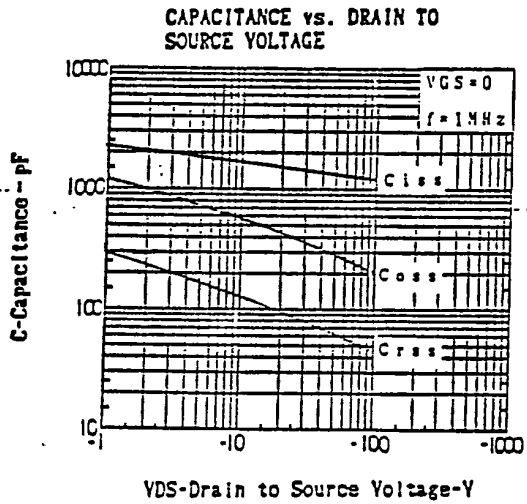
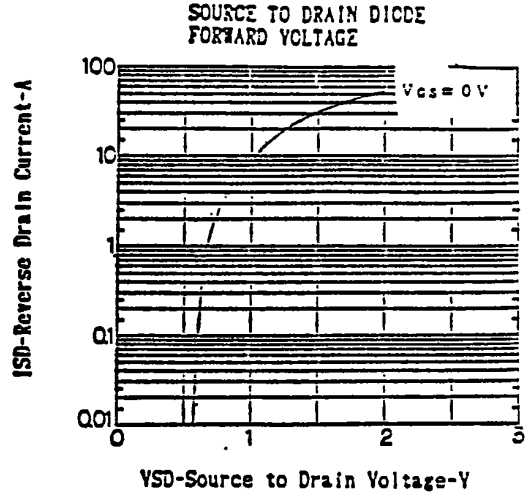
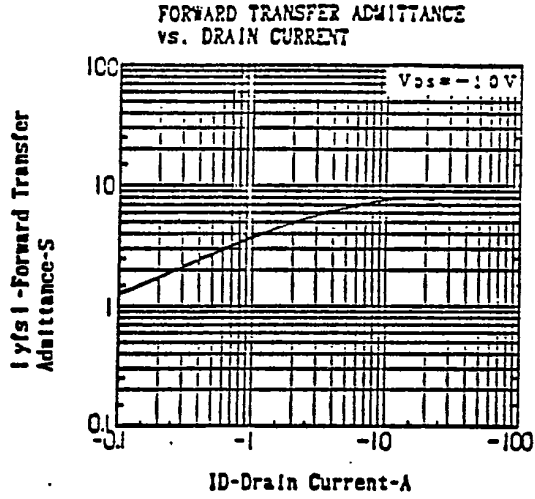

NEC ELECTRON DEVICE

TRANSFER CHARACTERISTICS

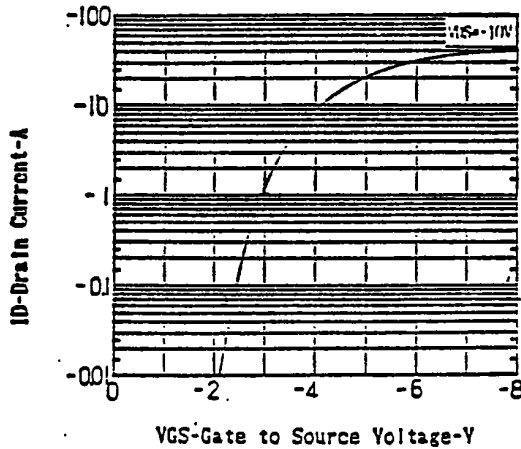

GATE TO SOURCE CUTOFF VOLTAGE vs. CHANNEL TEMPERATURE

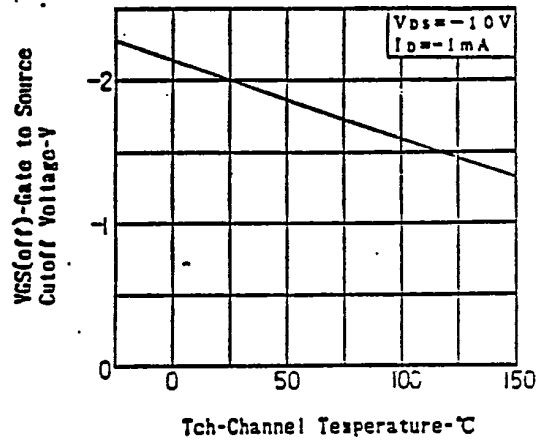

SWITCHING TIME vs. DRAIN CURRENT

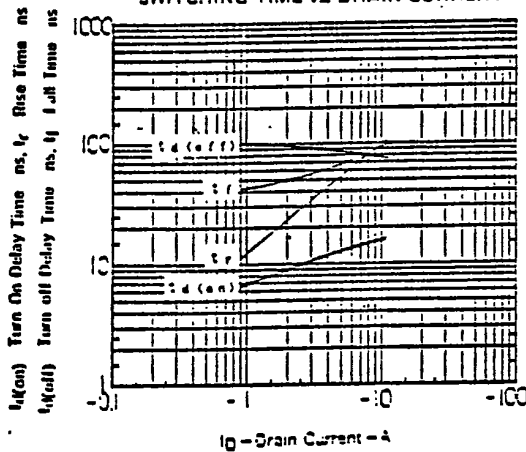

NEC Corporation

INTERNATIONAL ELECTRON DEVICES DIV.
 NEC Building, 33-1, Shiba Gochome
 Minato-ku, Tokyo 108, Japan
 Tel Tokyo 454-1111
 Telex Address: NECTOK J22586
 Cable Address: MICROPHONE TOKYO