

**2SC4054**  
(TP5V45FX)

**5A NPN**

### OUTLINE DIMENSIONS

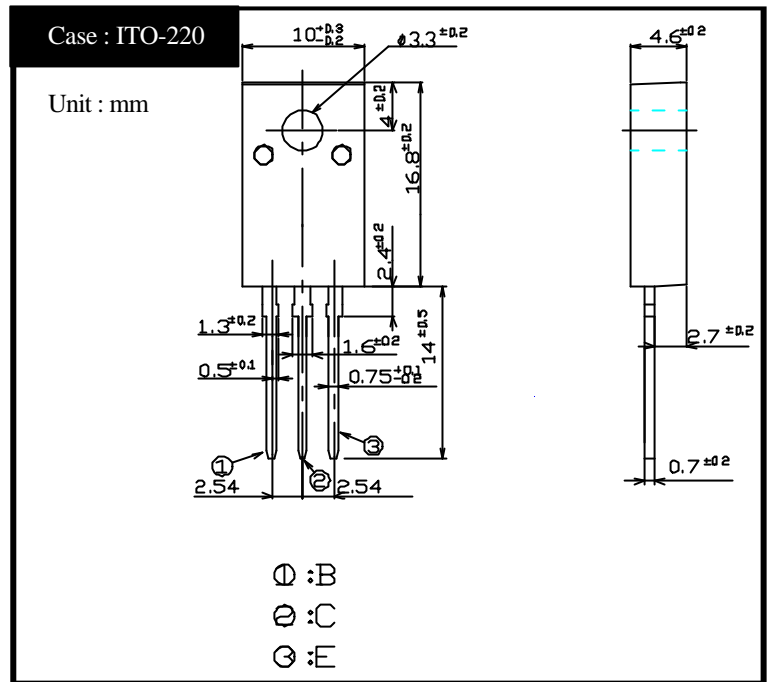

### RATINGS

#### Absolute Maximum Ratings

Item	Symbol	Conditions	Ratings	Unit
Storage Temperature	T <sub>stg</sub>		-55 ~ 150	
Junction Temperature	T <sub>j</sub>		150	
Collector to Base Voltage	V <sub>CBO</sub>		600	V
Collector to Emitter Voltage	V <sub>CEO</sub>		450	V
	V <sub>CEX</sub>	V <sub>EB</sub> = 5V	600	
Emitter to Base Voltage	V <sub>EBO</sub>		7	V
Collector Current DC	I <sub>C</sub>		5	A
Collector Current Peak	I <sub>CP</sub>		10	
Base Current DC	I <sub>B</sub>		2	A
Base Current Peak	I <sub>BP</sub>		4	
Total Transistor Dissipation	P <sub>T</sub>	T <sub>C</sub> = 25	30	W
Dielectric Strength	V <sub>dis</sub>	Terminals to case, AC 1 minute	2	kV
Mounting Torque	TOR		0.5	N·m

#### Electrical Characteristics (T<sub>c</sub>=25 °C)

Item	Symbol	Conditions	Ratings	Unit
Collector to Emitter Sustaining Voltage	V <sub>CEO(sus)</sub>	I <sub>C</sub> = 0.1A	Min 450	V
Collector Cutoff Current	I <sub>CBO</sub>	At rated Voltage	Max 0.1	mA
	I <sub>CEO</sub>		Max 0.1	
Emitter Cutoff Current	I <sub>EBO</sub>	At rated Voltage	Max 0.1	mA
DC Current Gain	h <sub>FE</sub>	V <sub>CE</sub> = 5V, I <sub>C</sub> = 2.5A	Min 10	
	h <sub>FEL</sub>	V <sub>CE</sub> = 5V, I <sub>C</sub> = 1mA	Min 5	
Collector to Emitter Saturation Voltage	V <sub>CE(sat)</sub>	I <sub>C</sub> = 2.5A	Max 1.0	V
Base to Emitter Saturation Voltage	V <sub>BE(sat)</sub>	I <sub>B</sub> = 0.5A	Max 1.5	V
Thermal Resistance	θ <sub>JC</sub>	Junction to case	Max 4.16	/W
Transition Frequency	f <sub>T</sub>	V <sub>CE</sub> = 10V, I <sub>C</sub> = 0.5A	STD 20	MHz
Turn on Time	t <sub>on</sub>	I <sub>C</sub> = 2.5A	Max 0.5	μs
Storage Time	t <sub>s</sub>	I <sub>B1</sub> = 0.5A, I <sub>B2</sub> = 1A	Max 2.0	
Fall Time	t <sub>f</sub>	R <sub>L</sub> = 60 Ω, V <sub>BB2</sub> = 4V	Max 0.2	

# 2SC4054

$h_{FE} - I_C$

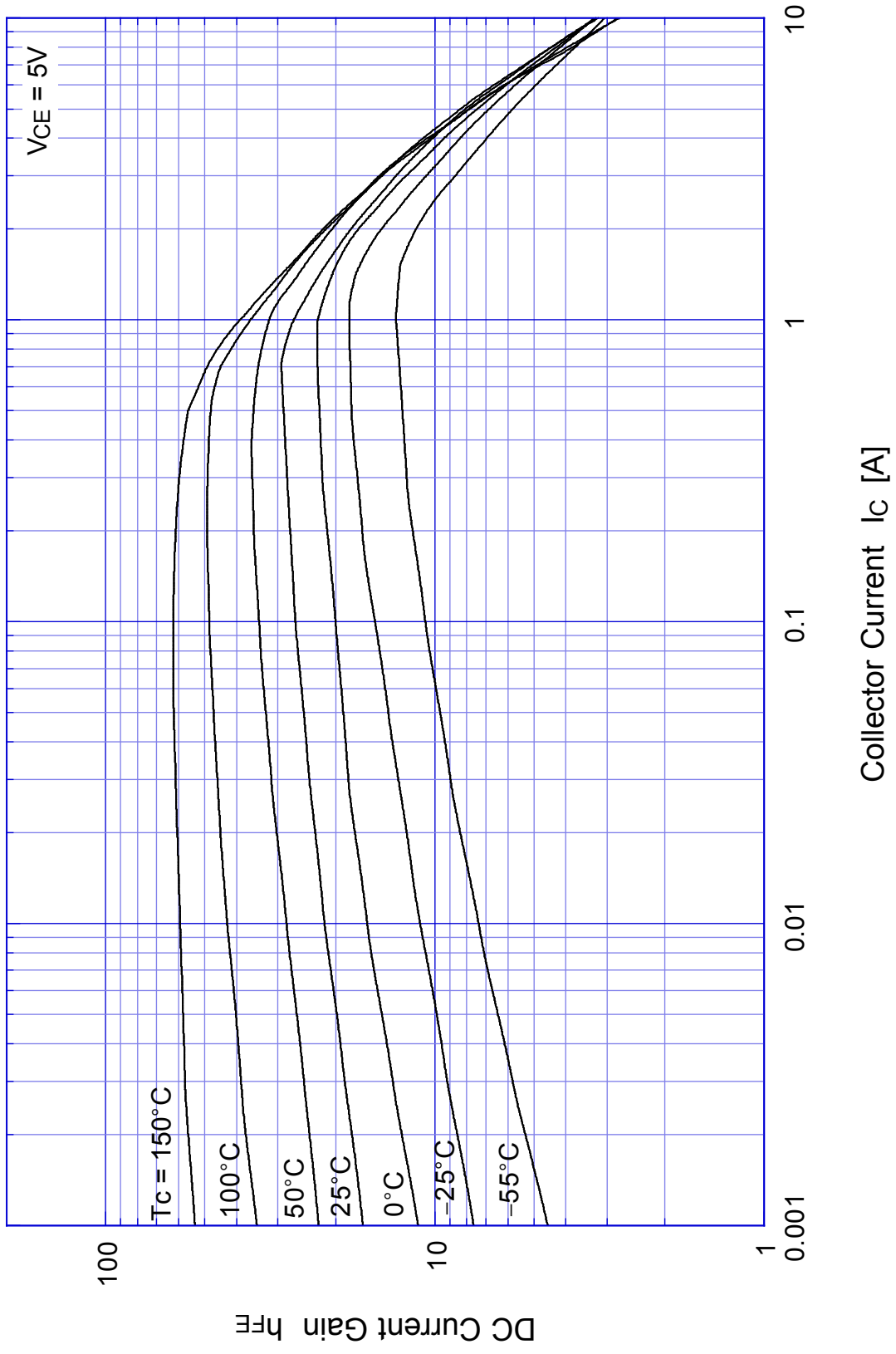

# 2SC4054 Saturation Voltage

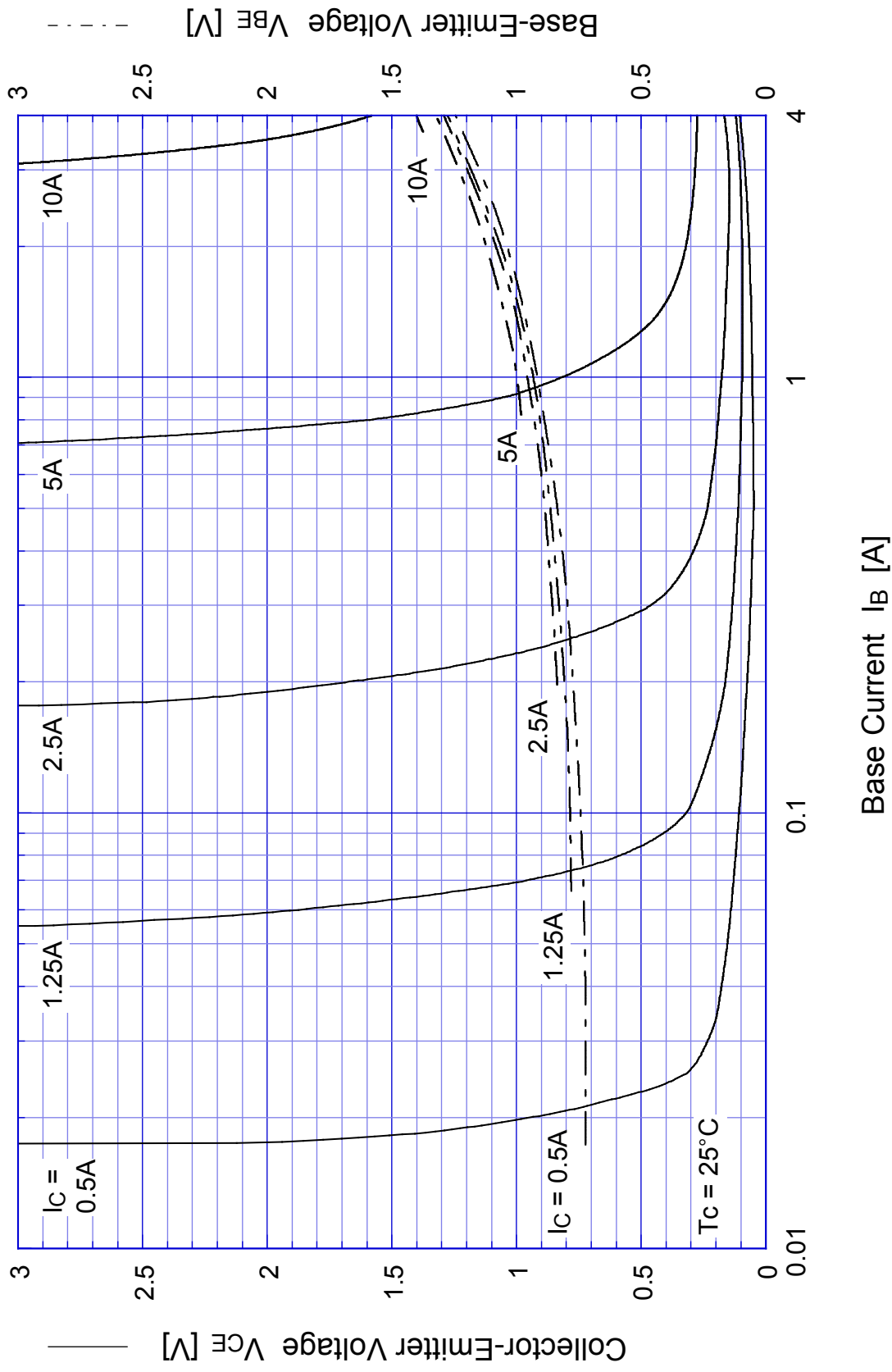

# 2SC4054

## Switching Time - $I_C$

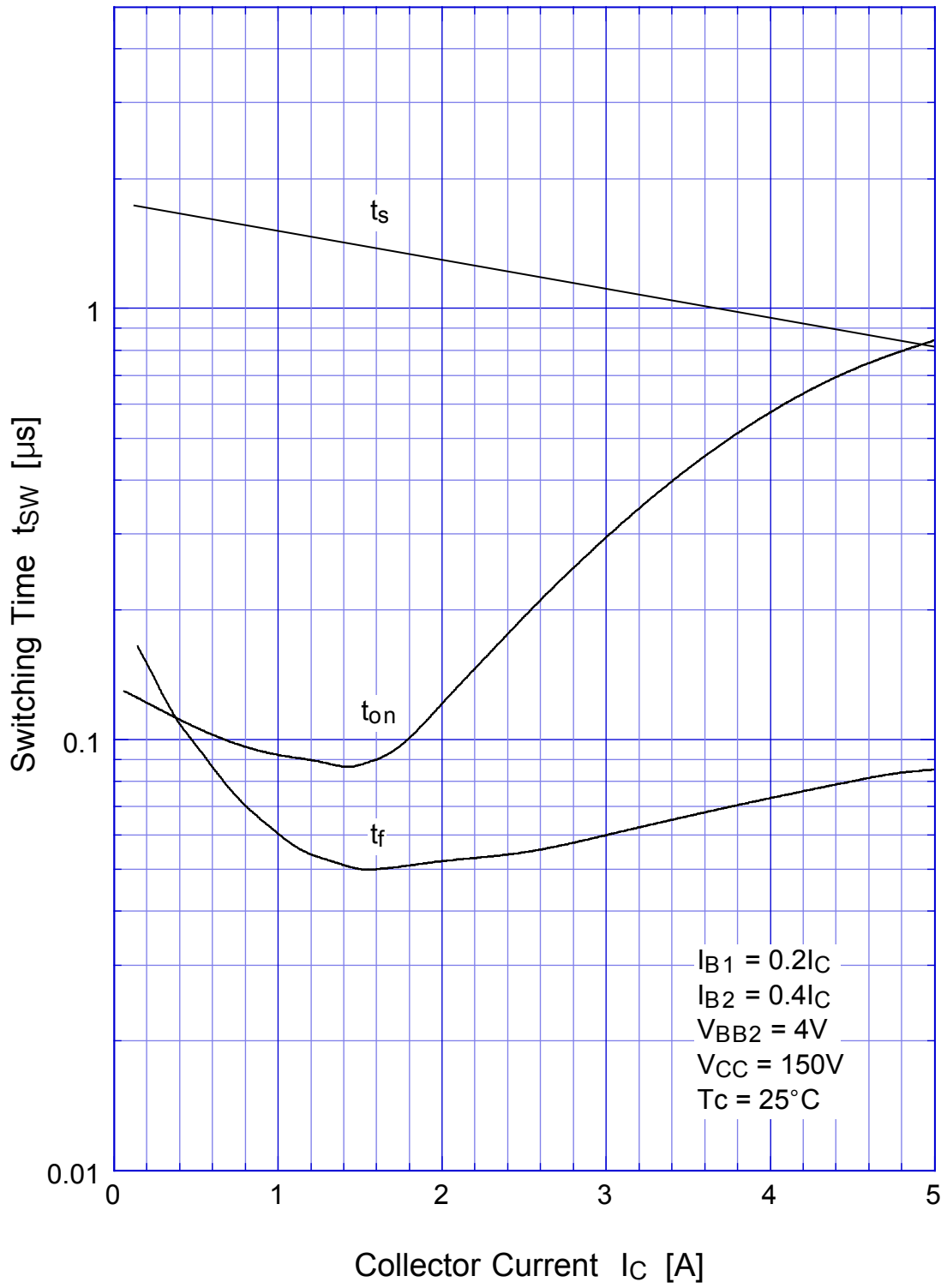

# 2SC4054 Switching Time - $V_{CC}$

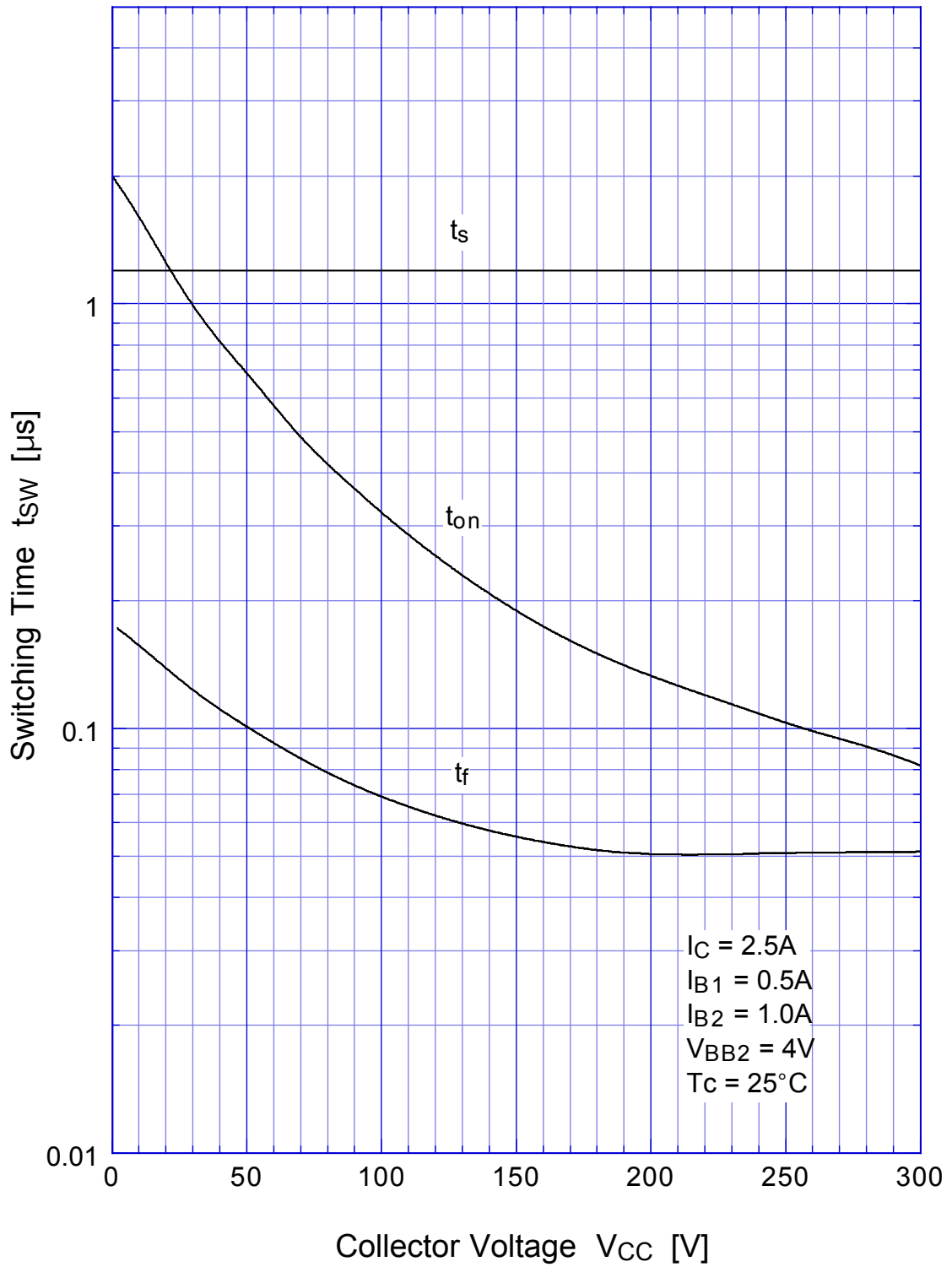

## 2SC4054 Collector Current Derating

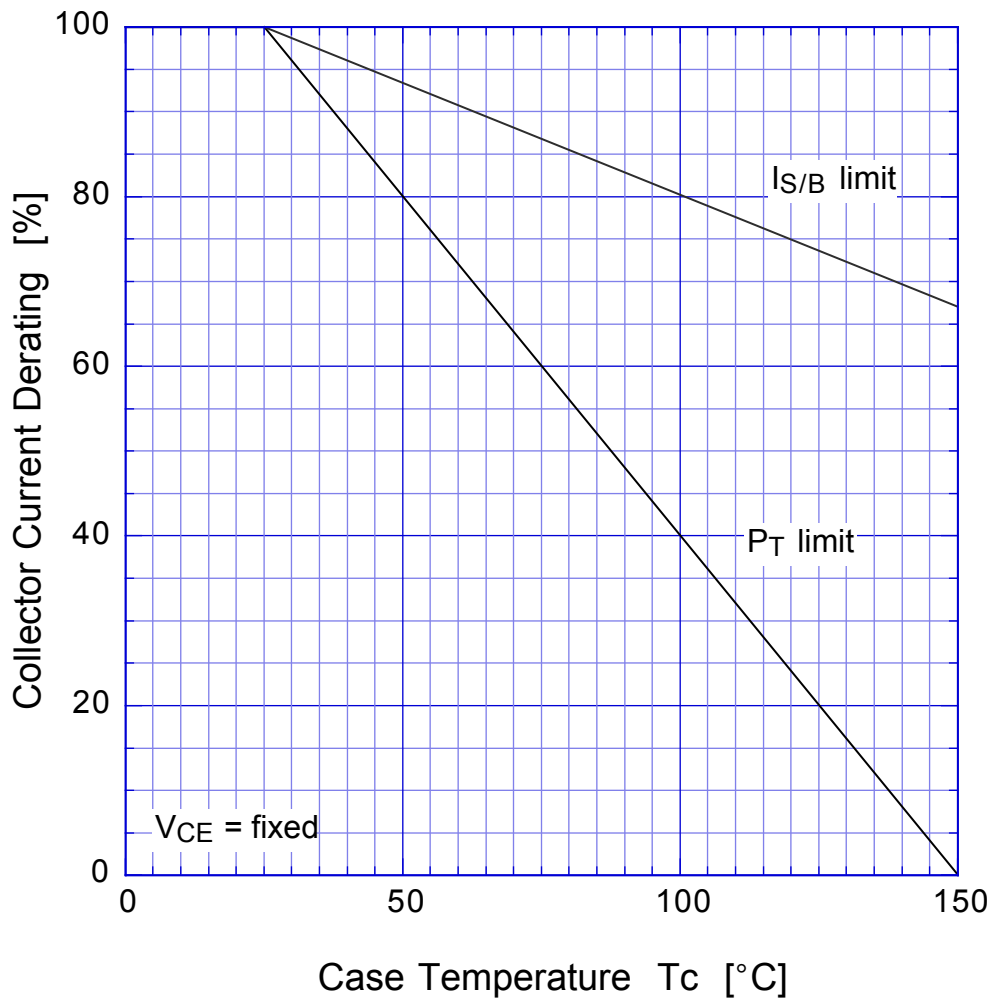

# 2SC4054 L-Load Switching Time - $I_C$

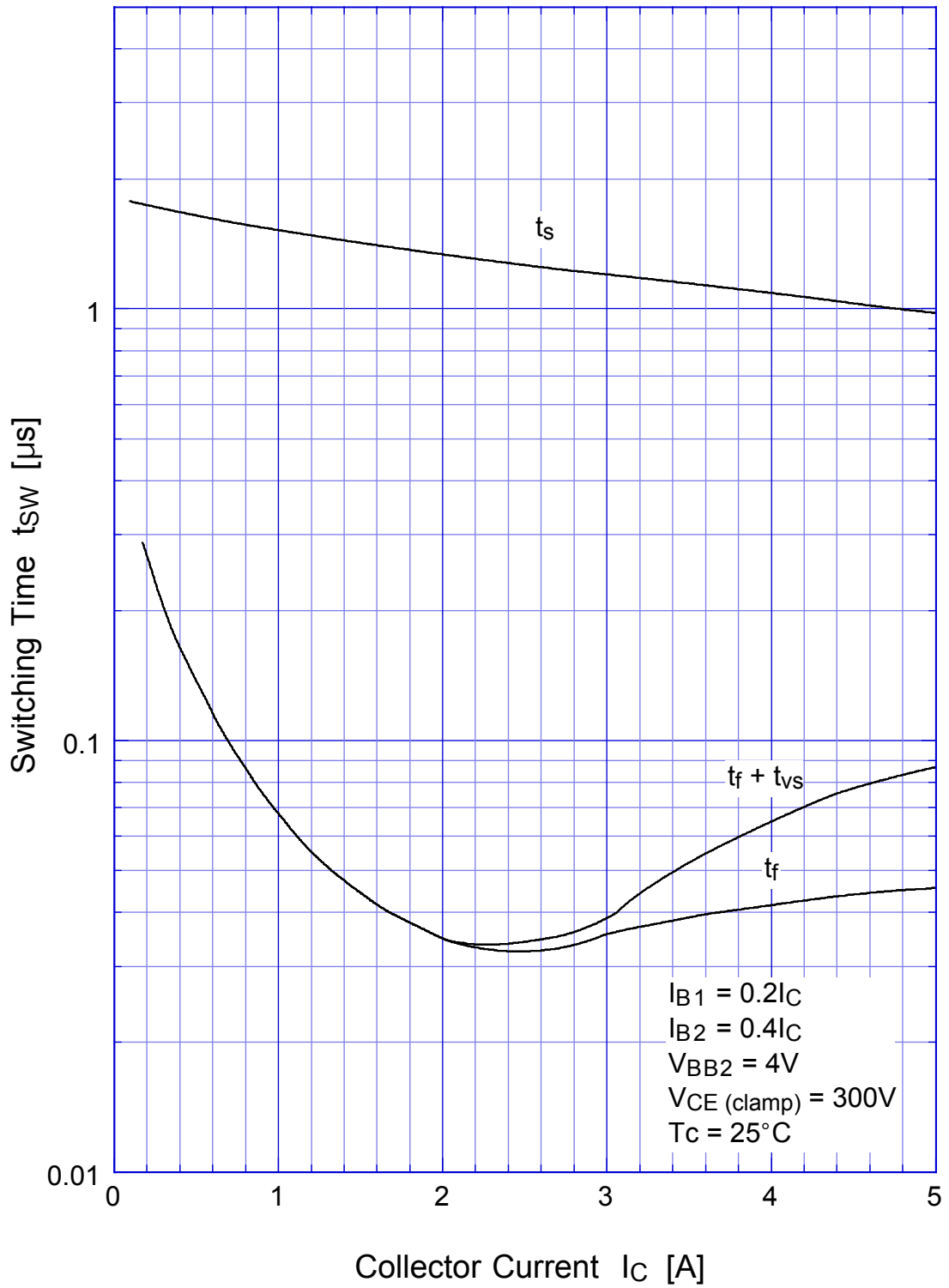

## 2SC4054 L-Load Switching Time - $I_C$ (At High Temperature)

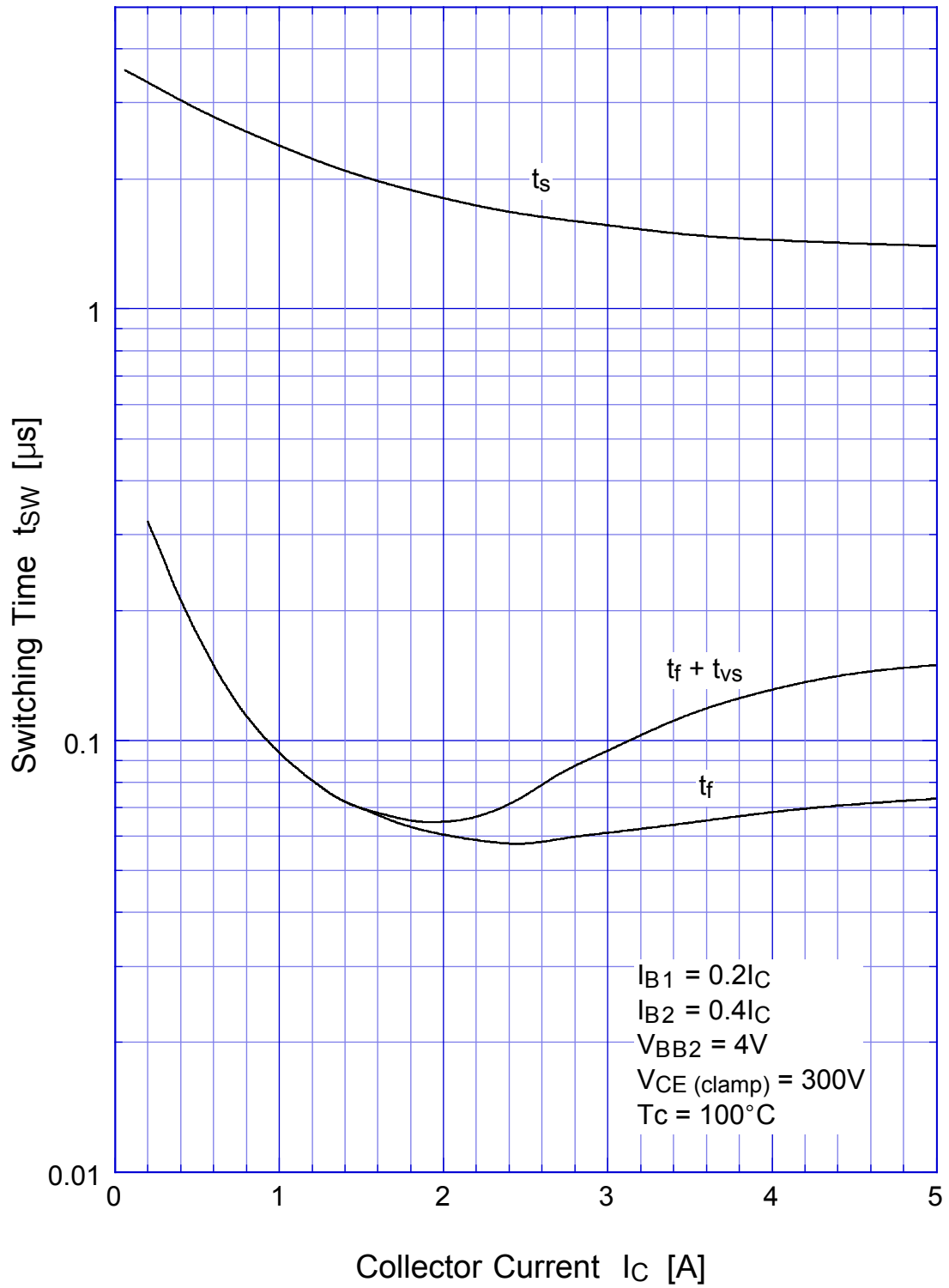



## 2SC4054 Transient Thermal Impedance

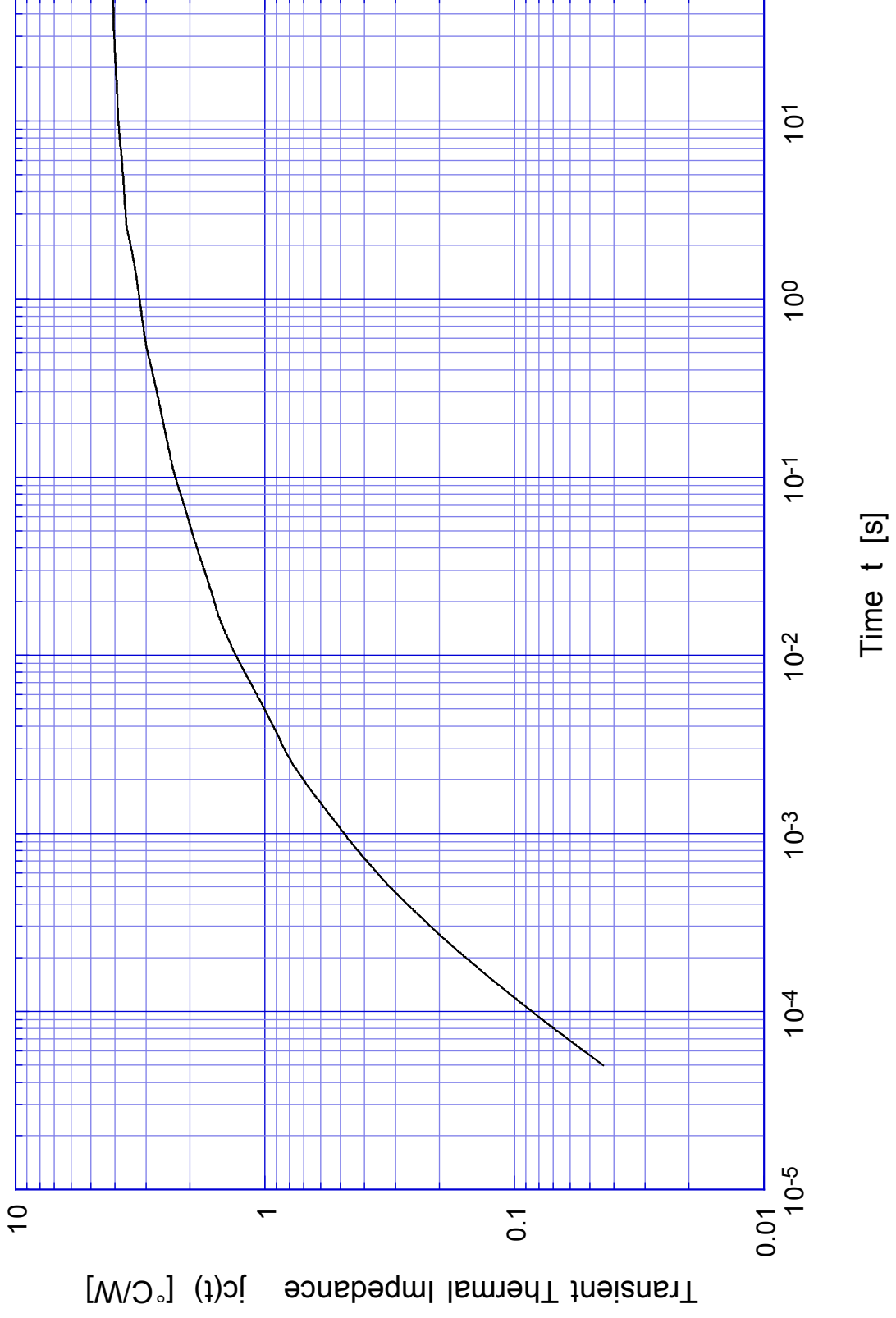

# 2SC4054

# Forward Bias SOA

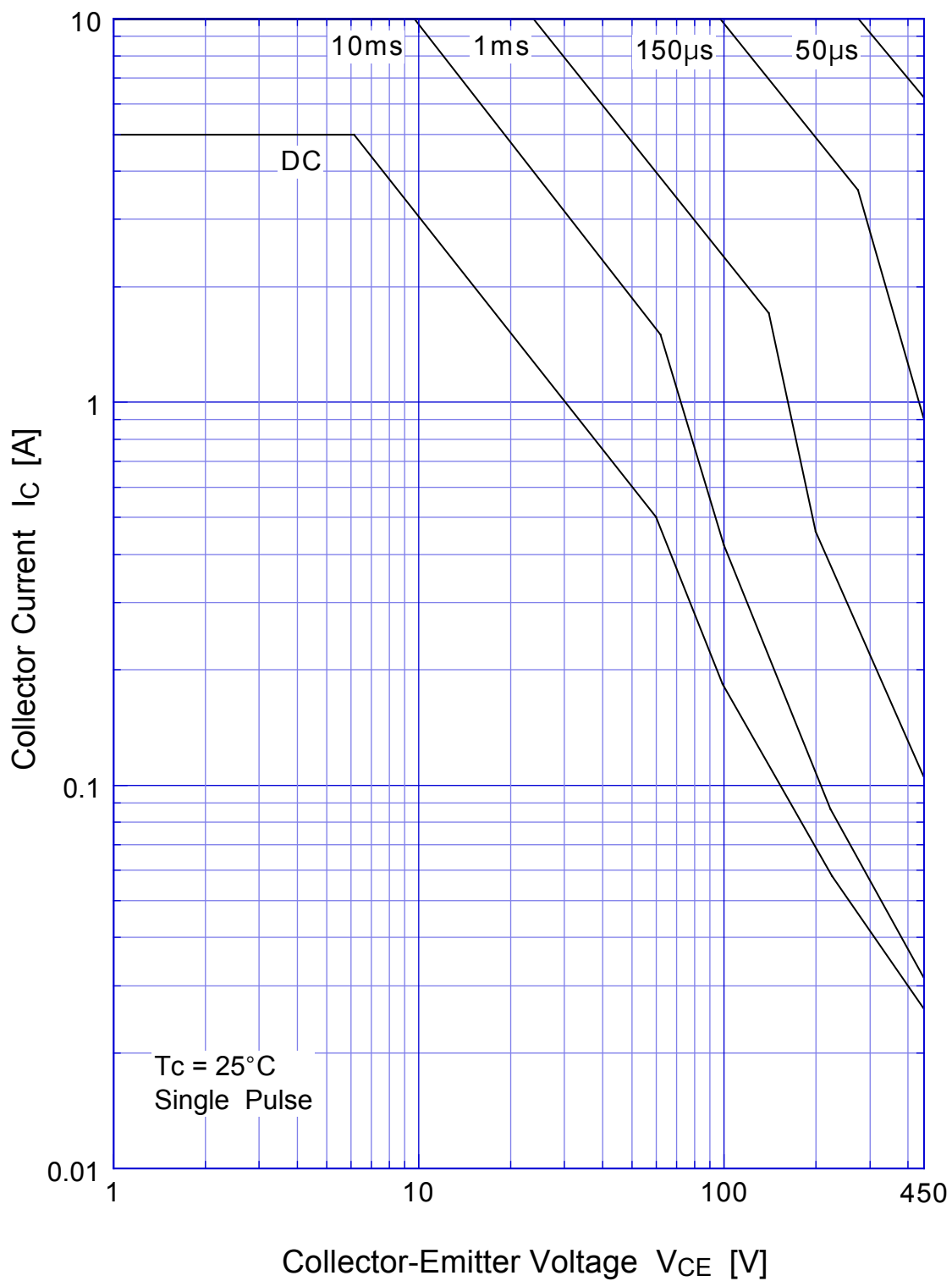

## 2SC4054 Collector Current Derating



2SC4054

Reverse Bias SOA

