

**DESCRIPTION** The 2SC3732 is designed for general purpose amplifier and high speed switching applications.

- FEATURES**
- High Frequency Current Gain.
  - High Speed Switching.
  - Small Output Capacitance.

**ABSOLUTE MAXIMUM RATINGS**

Maximum Temperatures	
Storage Temperature	-55 to +150 °C
Junction Temperature	150 °C Maximum
Maximum Power Dissipation (T <sub>a</sub> = 25 °C)	
Total Power Dissipation	250 mW
Maximum Voltages and Currents (T <sub>a</sub> = 25 °C)	
V <sub>CB0</sub> Collector to Base Voltage	40 V
V <sub>CES</sub> Collector to Emitter Voltage	40 V
V <sub>CEO</sub> Collector to Emitter Voltage	15 V
V <sub>EBO</sub> Emitter to Base Voltage	5.0 V
I <sub>C</sub> Collector Current	200 mA
I <sub>C</sub> Collector Current (10 μs pulse)	500 mA

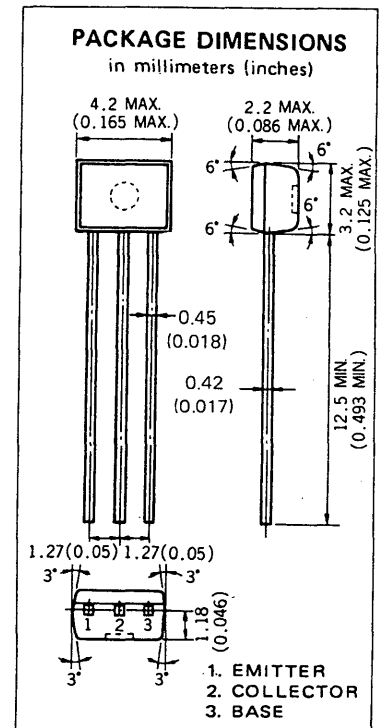

**ELECTRICAL CHARACTERISTICS (T<sub>a</sub> = 25 °C)**

SYMBOL	CHARACTERISTIC	MIN.	TYP.	MAX.	UNIT	TEST CONDITIONS
t <sub>on</sub>	Turn-on Time		8.0	12	ns	V <sub>CC</sub> = 3.0 V, I <sub>C</sub> = 10 mA, I <sub>B1</sub> = 3.0 mA, V <sub>BE</sub> = -1.5 V
t <sub>off</sub>	Turn-off Time		12	18	ns	V <sub>CC</sub> = 3.0 V, I <sub>C</sub> = 10 mA, I <sub>B1</sub> = 3.0 mA, I <sub>B2</sub> = -1.5 mA
t <sub>stg</sub>	Storage Time		6.0	13	ns	I <sub>C</sub> = 10 mA, I <sub>B1</sub> = -I <sub>B2</sub> = 10 mA
f <sub>T</sub>	Gain Bandwidth Product	500	750		MHz	V <sub>CE</sub> = 10 V, I <sub>E</sub> = -10 mA, f = 100 MHz
C <sub>ob</sub>	Output Capacitance		1.8	4.0	pF	V <sub>CB</sub> = 5.0 V, I <sub>E</sub> = 0, f = 1 MHz
h <sub>FE</sub> *	DC Current Gain	40	90	200	-	V <sub>CE</sub> = 1.0 V, I <sub>C</sub> = 10 mA
V <sub>CE(sat)</sub> *	Collector Saturation Voltage		0.15	0.25	V	I <sub>C</sub> = 10 mA, I <sub>B</sub> = 1.0 mA
V <sub>BE(sat)</sub> *	Base Saturation Voltage		0.80	0.85	V	I <sub>C</sub> = 10 mA, I <sub>B</sub> = 1.0 mA
I <sub>CBO</sub>	Collector Cutoff Current			0.1	μA	V <sub>CB</sub> = 20 V, I <sub>E</sub> = 0
I <sub>EBO</sub>	Emitter Cutoff Current			0.1	μA	V <sub>EB</sub> = 3.0 V, I <sub>C</sub> = 0

\* Pulsed PW ≤ 350 μs, Duty Cycle ≤ 2 %

**Classification of h<sub>FE</sub>**

Rank	M	L	K
Range	40 to 80	60 to 120	100 to 200

Test Conditions : V<sub>CE</sub> = 1.0 V, I<sub>C</sub> = 10 mA

TYPICAL CHARACTERISTICS ( $T_a = 25^\circ\text{C}$ )

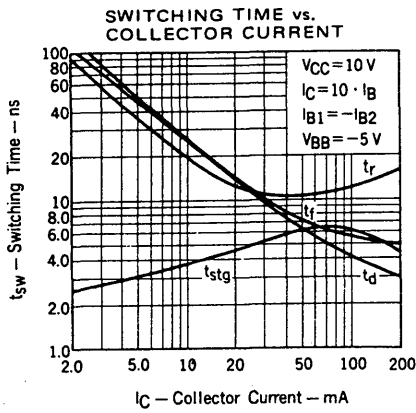
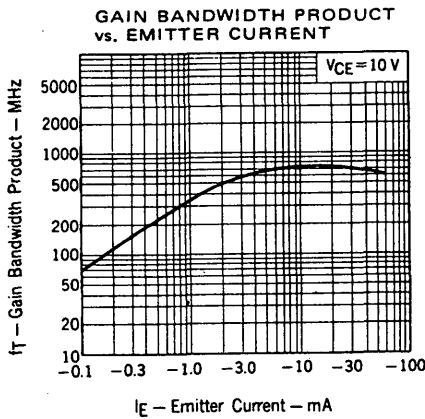
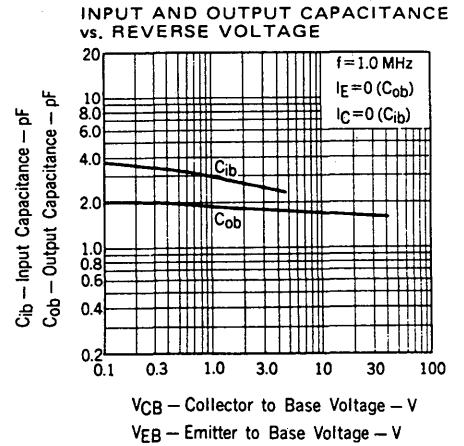
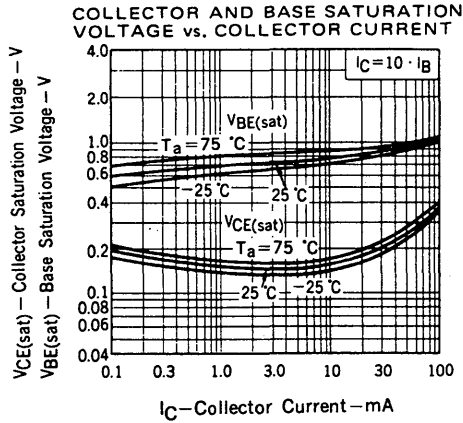
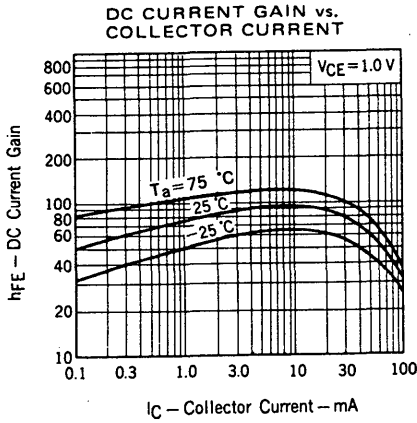
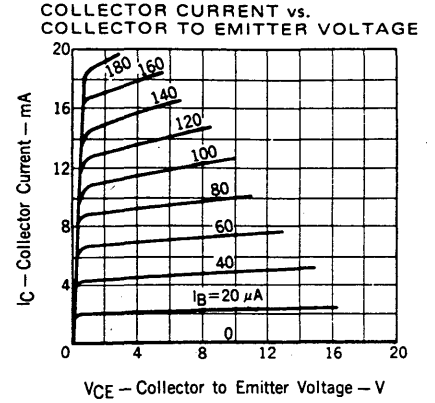
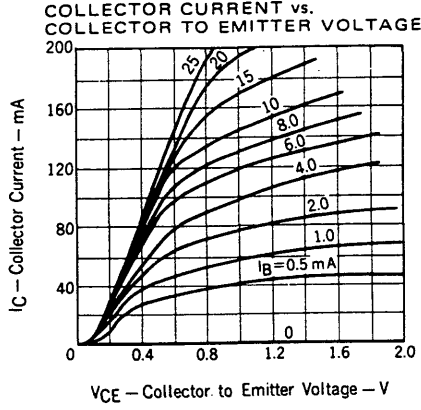
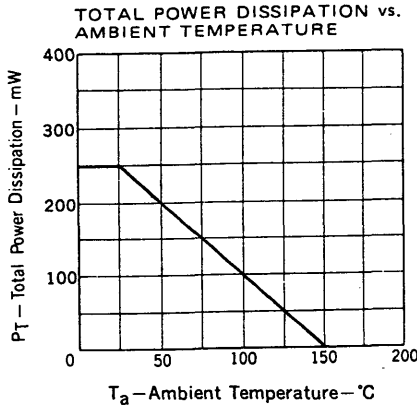

SWITCHING TIME TEST CIRCUIT

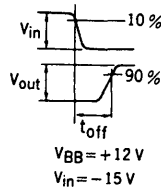
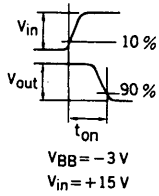
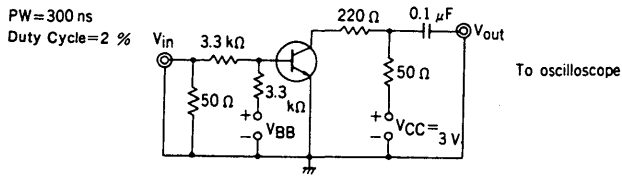

$t_{on}$ ,  $t_{off}$  SWITCHING

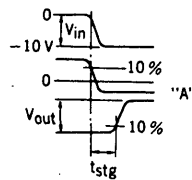
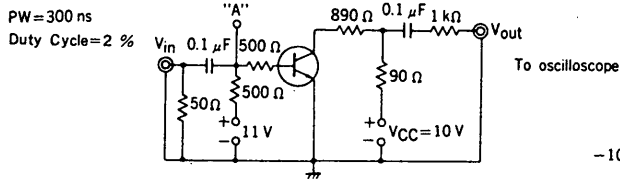

$t_{stg}$  SWITCHING

Voltage waveforms