

APPLICATIONS

- Rectification
- Freewheel Diode
- DC Motor Control
- Power Supplies
- Welding
- Battery Chargers

KEY PARAMETERS

V_{RRM}	3000V
$I_{F(AV)}$	1315A
I_{FSM}	20000A

FEATURES

- Double Side Cooling
- High Surge Capability

VOLTAGE RATINGS

Type Number	Repetitive Peak Reverse Voltage V_{RRM} V	Conditions
TR1104SG30	3000	$V_{RSM} = V_{RRM} + 100V$
TR1104SG29	2900	
TR1104SG28	2800	
TR1104SG27	2700	
TR1104SG26	2600	
TR1104SG25	2500	

Lower voltage grades available.

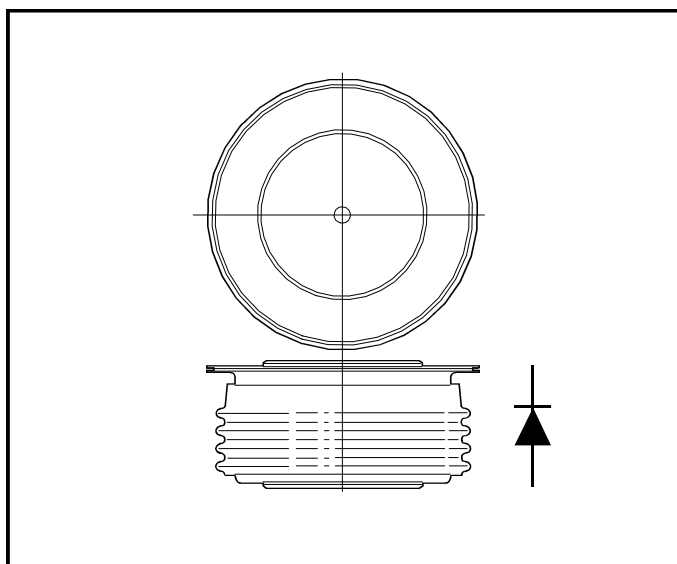

Outline type code: G.
See Package Details for further information.

CURRENT RATINGS

Symbol	Parameter	Conditions	Max.	Units
Double Side Cooled				
$I_{F(AV)}$	Mean forward current	Half wave resistive load, $T_{case} = 100^{\circ}C$	1315	A
$I_{F(RMS)}$	RMS value	$T_{case} = 100^{\circ}C$	2065	A
I_F	Continuous (direct) forward current	$T_{case} = 100^{\circ}C$	1880	A
Single Side Cooled (Anode side)				
$I_{F(AV)}$	Mean forward current	Half wave resistive load, $T_{case} = 100^{\circ}C$	840	A
$I_{F(RMS)}$	RMS value	$T_{case} = 100^{\circ}C$	1320	A
I_F	Continuous (direct) forward current	$T_{case} = 100^{\circ}C$	1130	A

SURGE RATINGS

Symbol	Parameter	Conditions	Max.	Units
I_{FSM}	Surge (non-repetitive) forward current	10ms half sine; $T_{case} = 175^{\circ}C$ $V_R = 50\% V_{RRM} - 1/4$ sine	16.0	kA
I^2t	I^2t for fusing		1.28×10^6	A ² s
I_{FSM}	Surge (non-repetitive) forward current	10ms half sine; $T_{case} = 175^{\circ}C$ $V_R = 0$	20.0	kA
I^2t	I^2t for fusing		2.0×10^6	A ² s

THERMAL AND MECHANICAL DATA

Symbol	Parameter	Conditions	Min.	Max.	Units	
$R_{th(j-c)}$	Thermal resistance - junction to case	Double side cooled	dc	-	0.032	°C/W
		Single side cooled	Anode dc	-	0.064	°C/W
			Cathode dc	-	0.064	°C/W
$R_{th(c-h)}$	Thermal resistance - case to heatsink	Clamping force 12.0kN with mounting compound	Double side	-	0.008	°C/W
			Single side	-	0.016	°C/W
T_{vj}	Virtual junction temperature	Forward (conducting)		-	185	°C
		Reverse (blocking)		-	175	°C
T_{stg}	Storage temperature range		-55	200	°C	
-	Clamping force		11.5	13.5	kN	

CHARACTERISTICS

Symbol	Parameter	Conditions	Min.	Max.	Units
V_{FM}	Forward voltage	At 1800A peak, $T_{case} = 25^{\circ}C$	-	1.3	V
I_{RRM}	Peak reverse current	At V_{RRM} , $T_{case} = 175^{\circ}C$	-	50	mA
Q_S	Total stored charge	$I_F = 1000A, di_{RR}/dt = 3A/\mu s$ $T_{case} = 175^{\circ}C, V_R = 100V$	-	1600	μC
I_{RR}	Peak recovery current		-	85	A
V_{TO}	Threshold voltage	At $T_{vj} = 175^{\circ}C$	-	0.67	V
r_T	Slope resistance	At $T_{vj} = 175^{\circ}C$	-	0.31	mΩ

CURVES

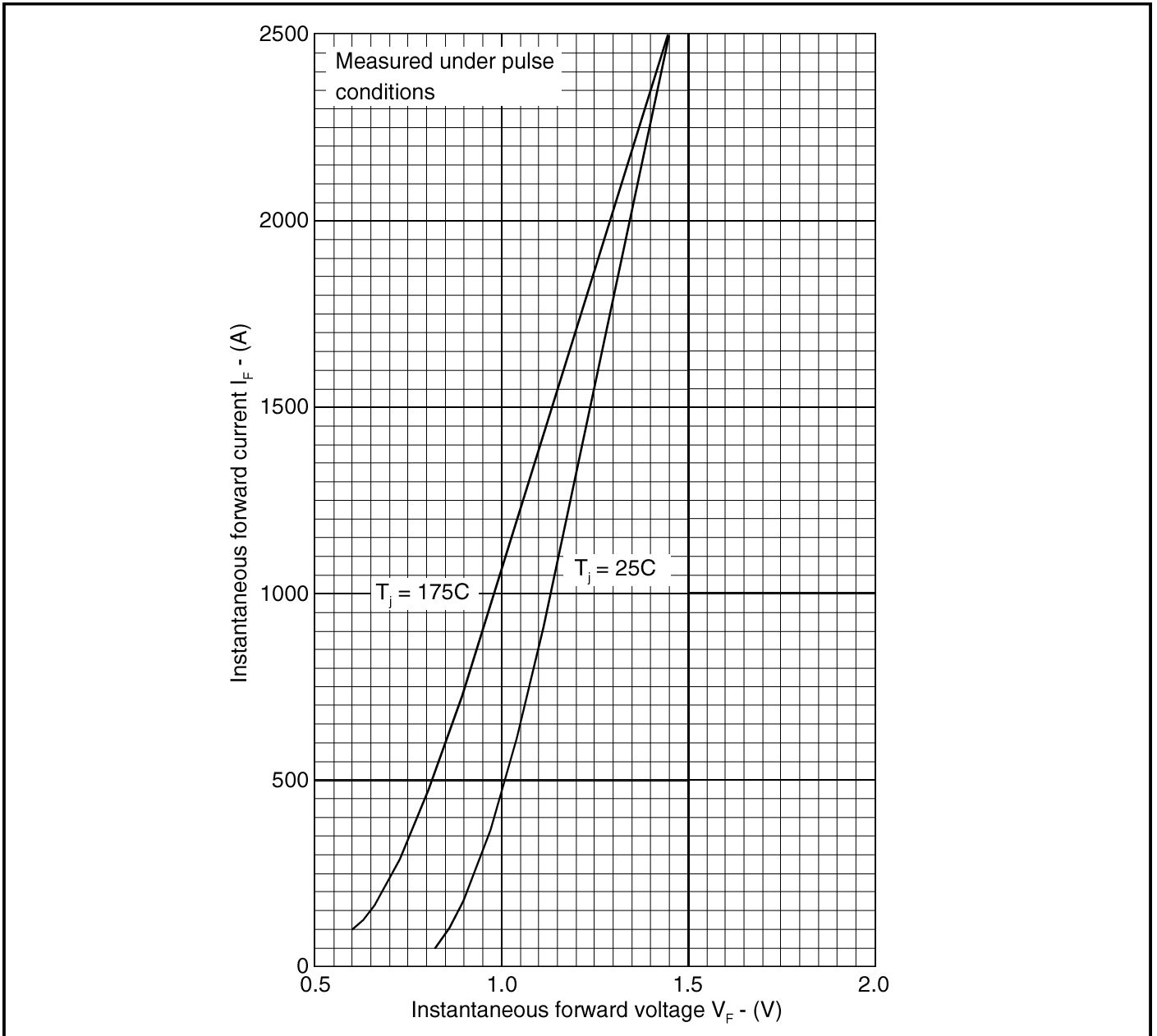

Fig. 1 Maximum (limit) forward characteristics

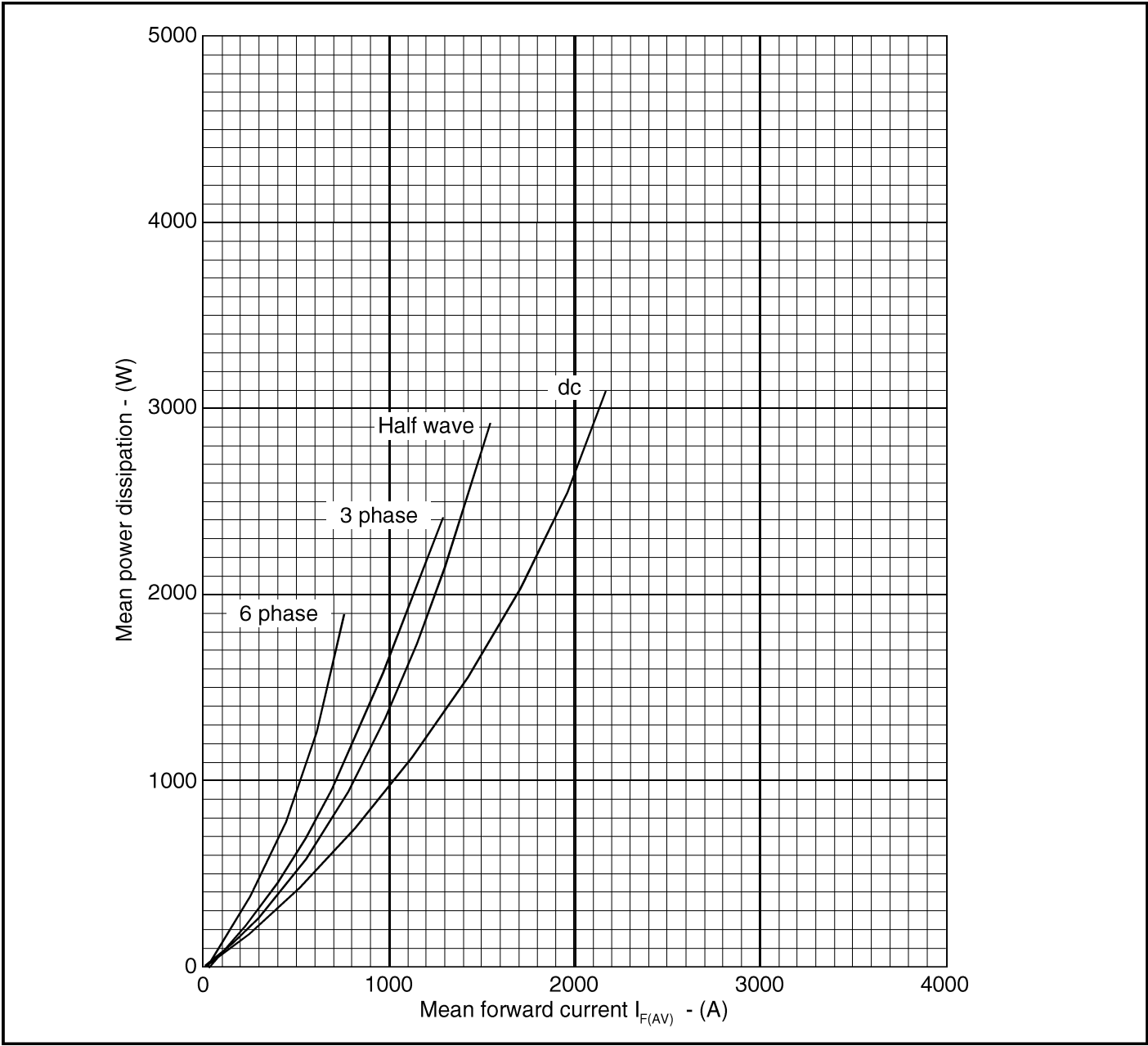

Fig. 2 Dissipation curves

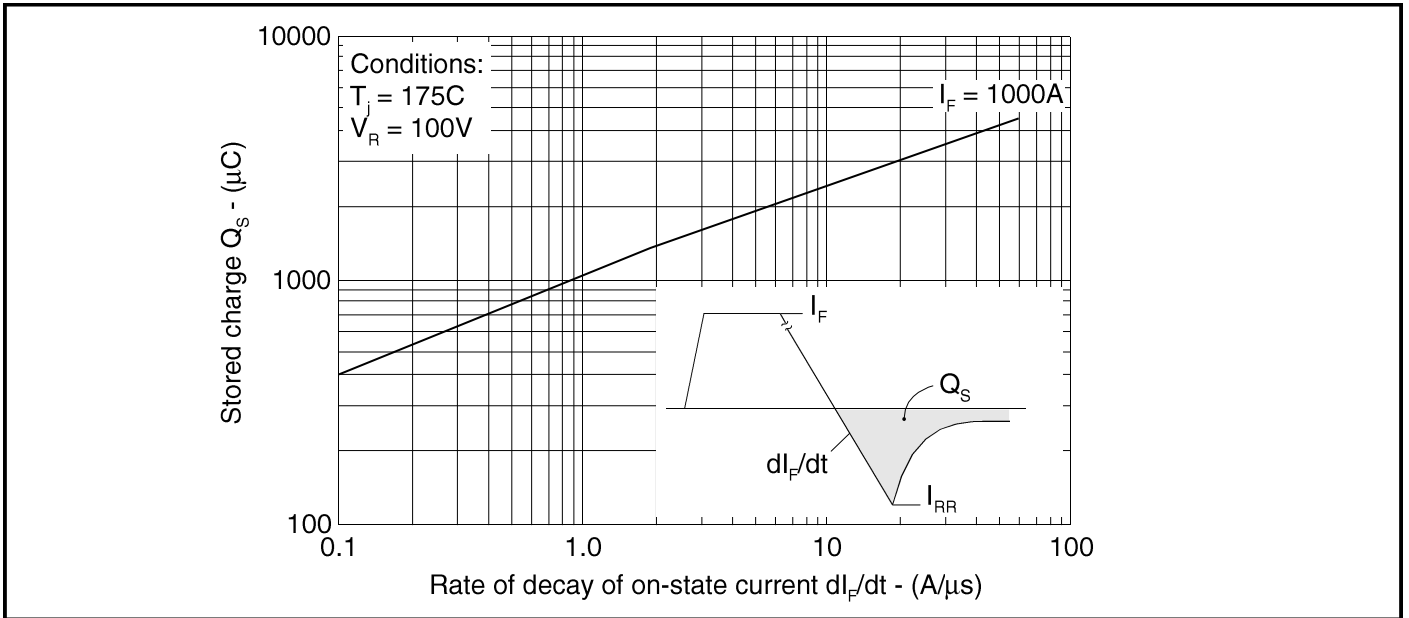

Fig. 3 Maximum total stored charge

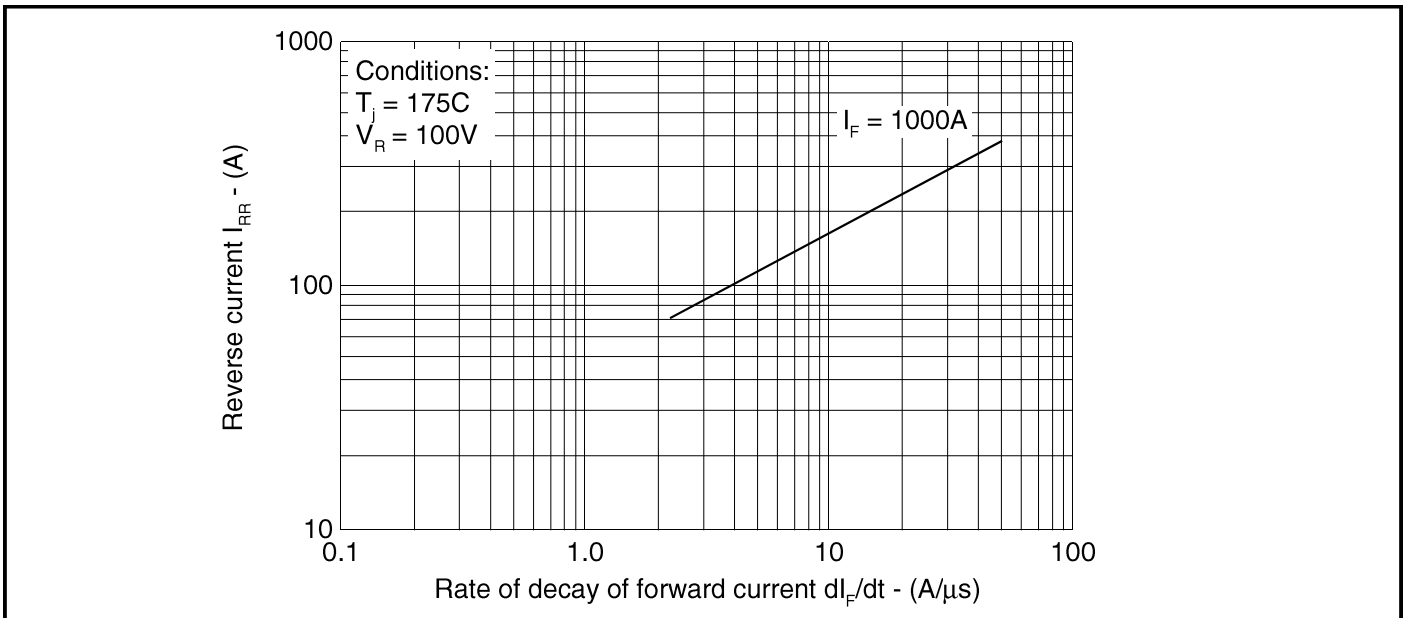

Fig. 4 Maximum reverse recovery current

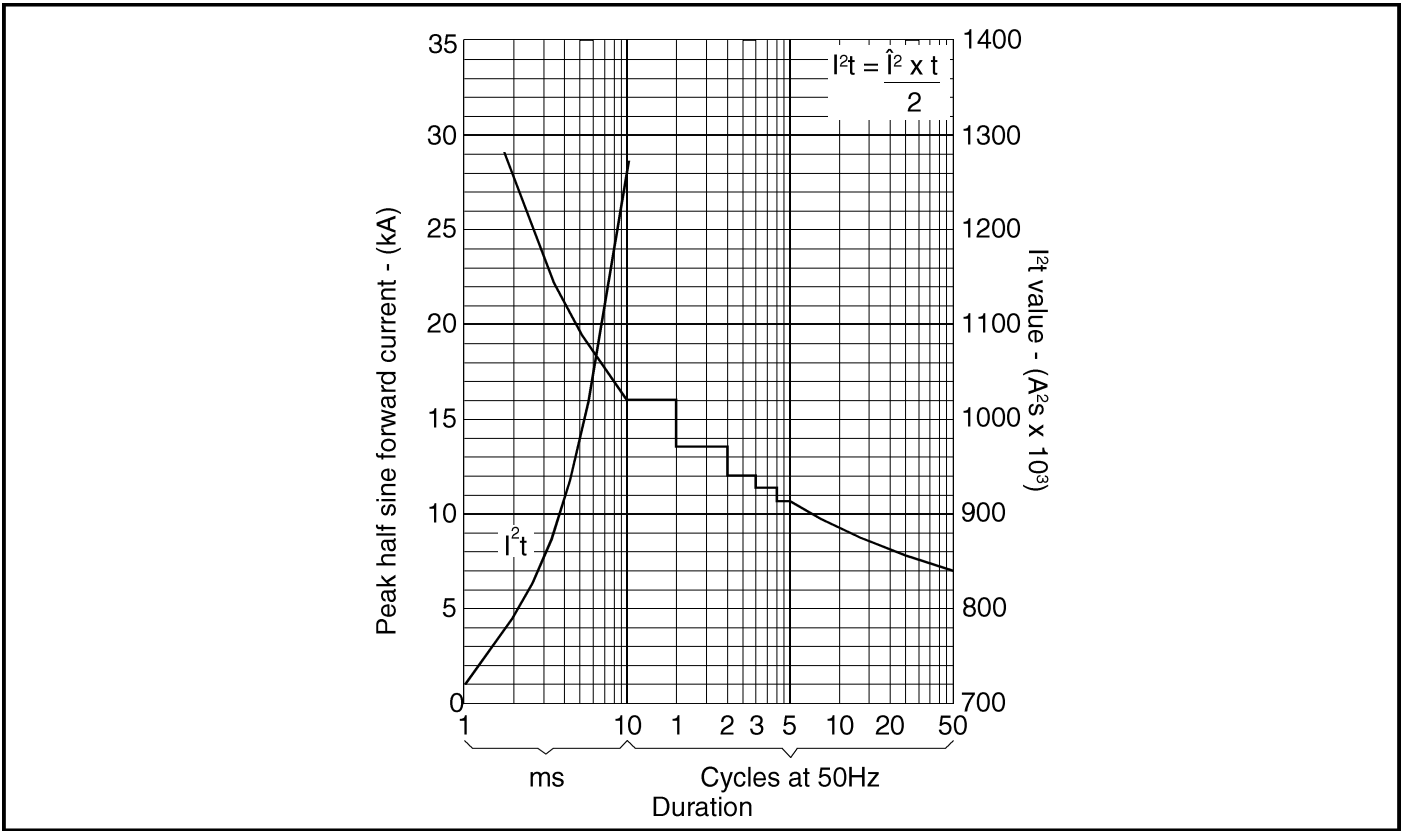

Fig. 5 Surge (non-repetitive) forward current vs time (with 50% V_{RRM} , $T_{case} = 175C$)

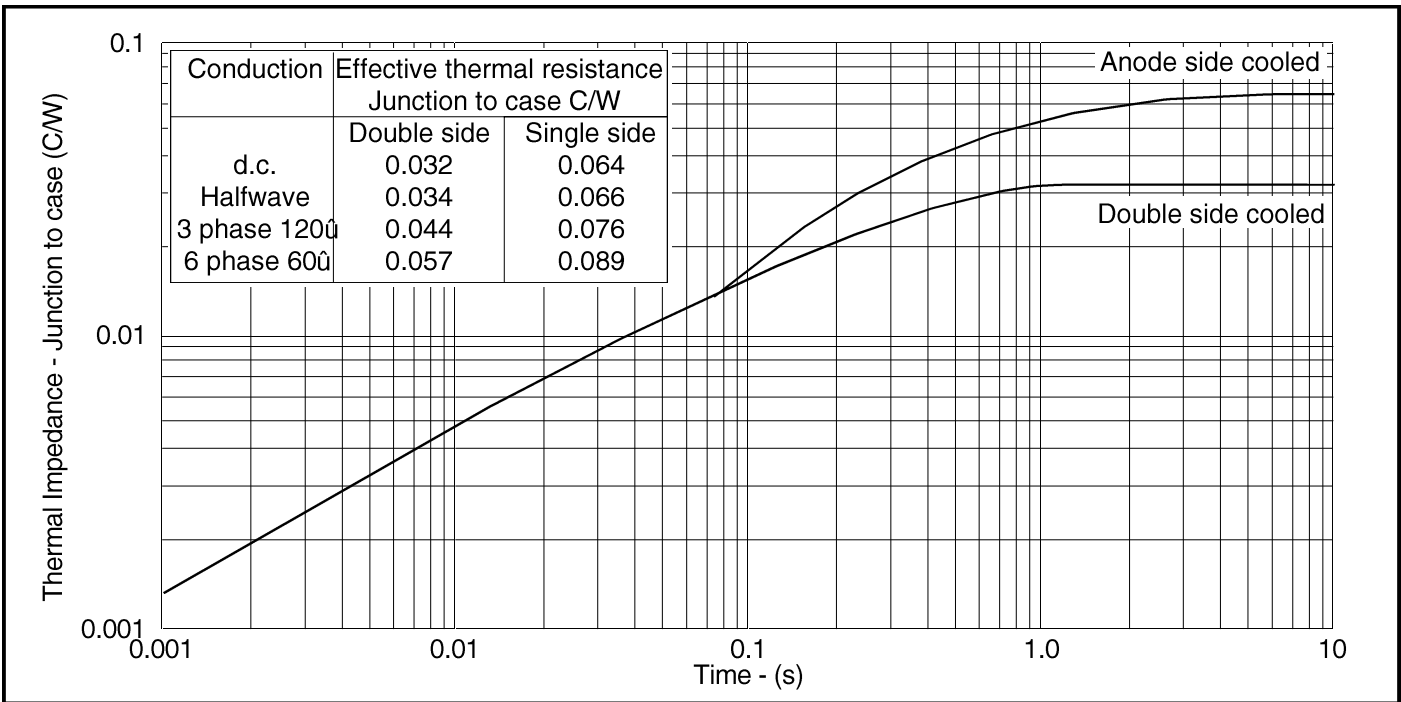

Fig. 6 Transient thermal impedance - junction to case - (C/W)

PACKAGE DETAILS

For further package information, please contact your local Customer Service Centre. All dimensions in mm, unless stated otherwise. DO NOT SCALE.

