

Dual Low Noise, Audio Amplifier

The LM833 is a standard low-cost monolithic dual general-purpose operational amplifier employing Bipolar technology with innovative high-performance concepts for audio systems applications. With high frequency PNP transistors, the LM833 offers low voltage noise ($4.5 \text{ nV}/\sqrt{\text{Hz}}$), 15 MHz gain bandwidth product, $7.0 \text{ V}/\mu\text{s}$ slew rate, 0.3 mV input offset voltage with $2.0 \mu\text{V}/^\circ\text{C}$ temperature coefficient of input offset voltage. The LM833 output stage exhibits no deadband crossover distortion, large output voltage swing, excellent phase and gain margins, low open loop high frequency output impedance and symmetrical source/sink AC frequency response.

The LM833 is specified over the automotive temperature range and is available in the plastic DIP and SO-8 packages (P and D suffixes). For an improved performance dual/quad version, see the MC33079 family.

- Low Voltage Noise: $4.5 \text{ nV}/\sqrt{\text{Hz}}$
- High Gain Bandwidth Product: 15 MHz
- High Slew Rate: $7.0 \text{ V}/\mu\text{s}$
- Low Input Offset Voltage: 0.3 mV
- Low T.C. of Input Offset Voltage: $2.0 \mu\text{V}/^\circ\text{C}$
- Low Distortion: 0.002%
- Excellent Frequency Stability
- Dual Supply Operation

MAXIMUM RATINGS

Rating	Symbol	Value	Unit
Supply Voltage (V_{CC} to V_{EE})	V_S	+36	V
Input Differential Voltage Range (Note 1)	V_{IDR}	30	V
Input Voltage Range (Note 1)	V_{IR}	± 15	V
Output Short Circuit Duration (Note 2)	t_{SC}	Indefinite	
Operating Ambient Temperature Range	T_A	-40 to $+85$	$^\circ\text{C}$
Operating Junction Temperature	T_J	+150	$^\circ\text{C}$
Storage Temperature	T_{stg}	-60 to $+150$	$^\circ\text{C}$
Maximum Power Dissipation (Notes 2 and 3)	P_D	500	mW

- NOTES:**
1. Either or both input voltages must not exceed the magnitude of V_{CC} or V_{EE} .
 2. Power dissipation must be considered to ensure maximum junction temperature (T_J) is not exceeded (see power dissipation performance characteristic).
 3. Maximum value at $T_A \leq 85^\circ\text{C}$.

LM833

DUAL OPERATIONAL AMPLIFIER

SEMICONDUCTOR TECHNICAL DATA

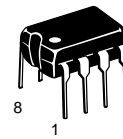

N SUFFIX
PLASTIC PACKAGE
CASE 626



D SUFFIX
PLASTIC PACKAGE
CASE 751
(SO-8)

PIN CONNECTIONS

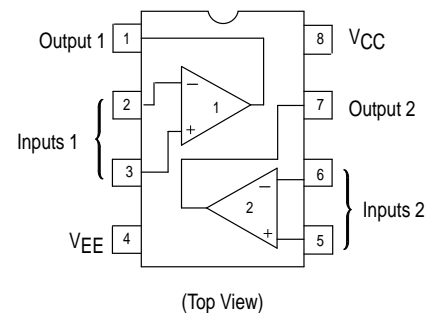

ORDERING INFORMATION

Device	Operating Temperature Range	Package
LM833N	$T_A = -40^\circ$ to $+85^\circ\text{C}$	Plastic DIP
LM833D		SO-8

LM833

ELECTRICAL CHARACTERISTICS ($V_{CC} = +15\text{ V}$, $V_{EE} = -15\text{ V}$, $T_A = 25^\circ\text{C}$, unless otherwise noted.)

Characteristic	Symbol	Min	Typ	Max	Unit
Input Offset Voltage ($R_S = 10\ \Omega$, $V_O = 0\text{ V}$)	V_{IO}	–	0.3	5.0	mV
Average Temperature Coefficient of Input Offset Voltage $R_S = 10\ \Omega$, $V_O = 0\text{ V}$, $T_A = T_{low}$ to T_{high}	$\Delta V_{IO}/\Delta T$	–	2.0	–	$\mu\text{V}/^\circ\text{C}$
Input Offset Current ($V_{CM} = 0\text{ V}$, $V_O = 0\text{ V}$)	I_{IO}	–	10	200	nA
Input Bias Current ($V_{CM} = 0\text{ V}$, $V_O = 0\text{ V}$)	I_{IB}	–	300	1000	nA
Common Mode Input Voltage Range	V_{ICR}	– –12	+14 –14	+12 –	V
Large Signal Voltage Gain ($R_L = 2.0\text{ k}\Omega$, $V_O = \pm 10\text{ V}$)	A_{VOL}	90	110	–	dB
Output Voltage Swing: $R_L = 2.0\text{ k}\Omega$, $V_{ID} = 1.0\text{ V}$ $R_L = 2.0\text{ k}\Omega$, $V_{ID} = 1.0\text{ V}$ $R_L = 10\text{ k}\Omega$, $V_{ID} = 1.0\text{ V}$ $R_L = 10\text{ k}\Omega$, $V_{ID} = 1.0\text{ V}$	V_{O+} V_{O-} V_{O+} V_{O-}	10 – 12 –	13.7 –14.1 13.9 –14.7	– –10 – –12	V
Common Mode Rejection ($V_{in} = \pm 12\text{ V}$)	CMR	80	100	–	dB
Power Supply Rejection ($V_S = 15\text{ V}$ to 5.0 V , -15 V to -5.0 V)	PSR	80	115	–	dB
Power Supply Current ($V_O = 0\text{ V}$, Both Amplifiers)	I_D	–	4.0	8.0	mA

AC ELECTRICAL CHARACTERISTICS ($V_{CC} = +15\text{ V}$, $V_{EE} = -15\text{ V}$, $T_A = 25^\circ\text{C}$, unless otherwise noted.)

Characteristic	Symbol	Min	Typ	Max	Unit
Slew Rate ($V_{in} = -10\text{ V}$ to $+10\text{ V}$, $R_L = 2.0\text{ k}\Omega$, $A_V = +1.0$)	S_R	5.0	7.0	–	$\text{V}/\mu\text{s}$
Gain Bandwidth Product ($f = 100\text{ kHz}$)	GBW	10	15	–	MHz
Unity Gain Frequency (Open Loop)	f_U	–	9.0	–	MHz
Unity Gain Phase Margin (Open Loop)	θ_m	–	60	–	Deg
Equivalent Input Noise Voltage ($R_S = 100\ \Omega$, $f = 1.0\text{ kHz}$)	e_n	–	4.5	–	$\text{nV}/\sqrt{\text{Hz}}$
Equivalent Input Noise Current ($f = 1.0\text{ kHz}$)	i_n	–	0.5	–	$\text{pA}/\sqrt{\text{Hz}}$
Power Bandwidth ($V_O = 27\text{ V}_{pp}$, $R_L = 2.0\text{ k}\Omega$, $\text{THD} \leq 1.0\%$)	BWP	–	120	–	kHz
Distortion ($R_L = 2.0\text{ k}\Omega$, $f = 20\text{ Hz}$ to 20 kHz , $V_O = 3.0\text{ V}_{rms}$, $A_V = +1.0$)	THD	–	0.002	–	%
Channel Separation ($f = 20\text{ Hz}$ to 20 kHz)	C_S	–	–120	–	dB

Figure 1. Maximum Power Dissipation versus Temperature

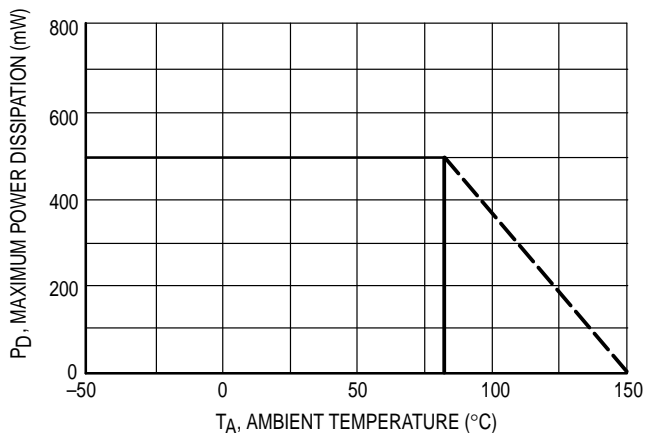

Figure 2. Input Bias Current versus Temperature

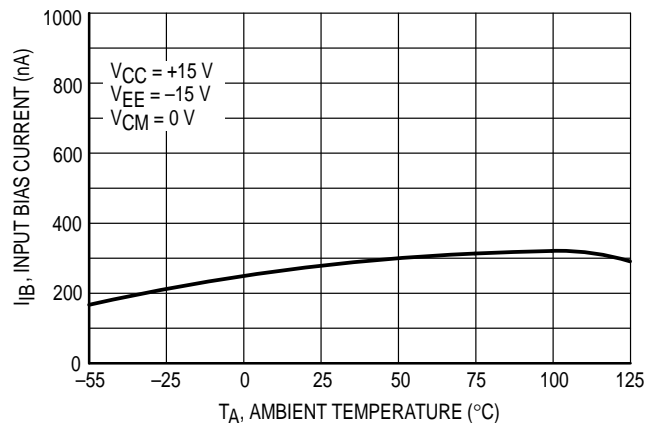

Figure 3. Input Bias Current versus Supply Voltage

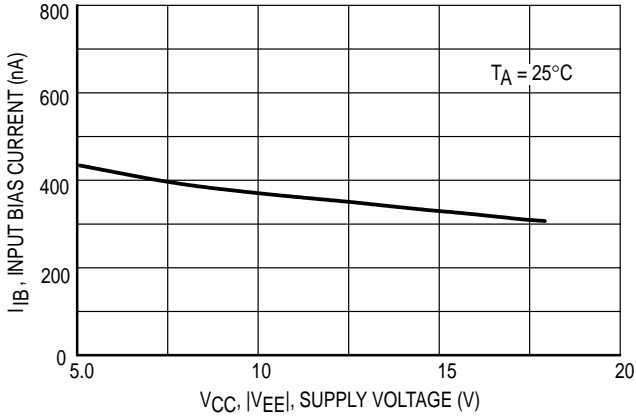

Figure 4. Supply Current versus Supply Voltage

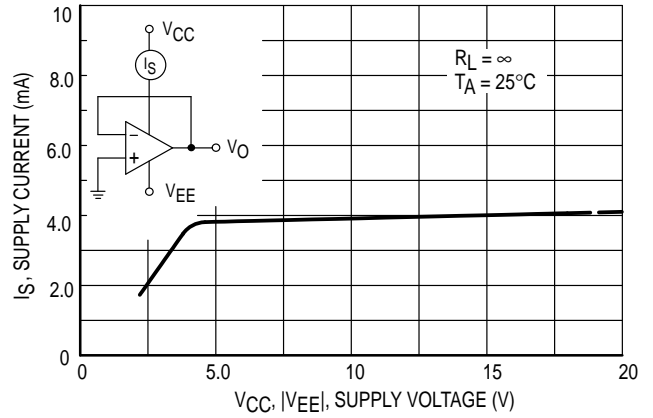

Figure 5. DC Voltage Gain versus Temperature

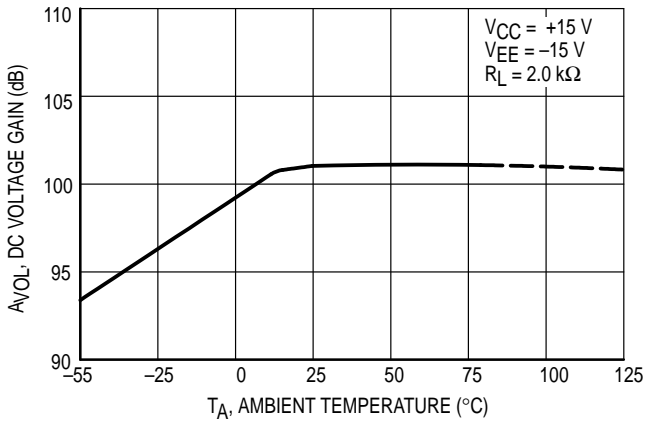

Figure 6. DC Voltage Gain versus Supply Voltage

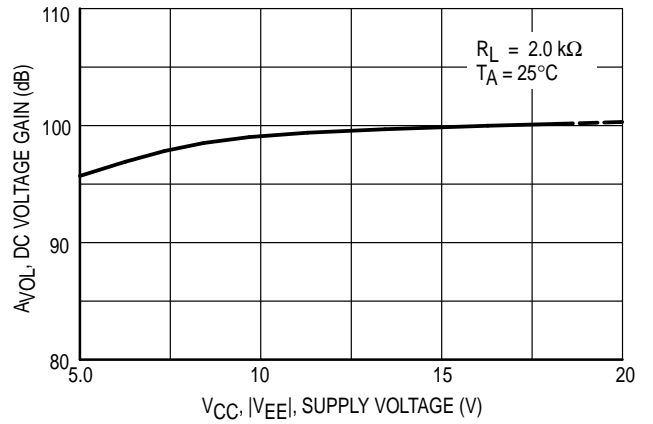

Figure 7. Open Loop Voltage Gain and Phase versus Frequency

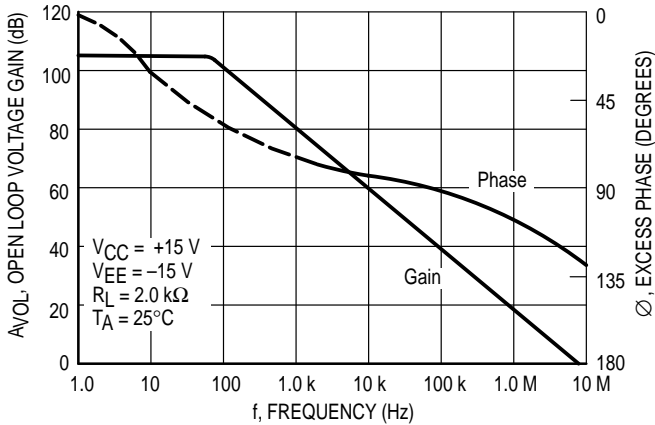

Figure 8. Gain Bandwidth Product versus Temperature

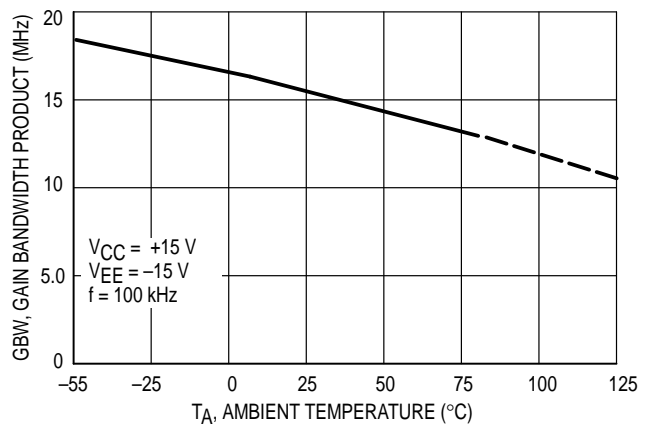

Figure 9. Gain Bandwidth Product versus Supply Voltage

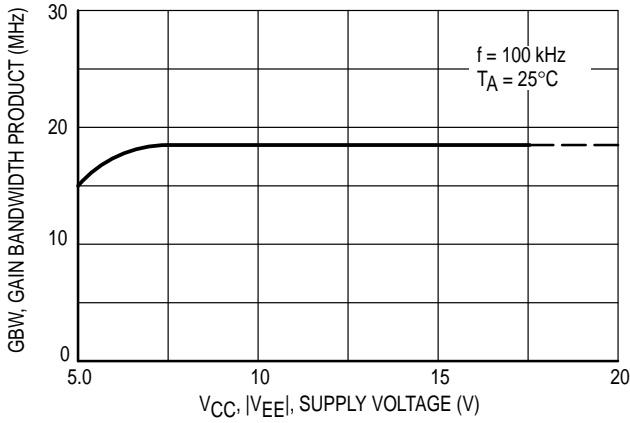

Figure 10. Slew Rate versus Temperature

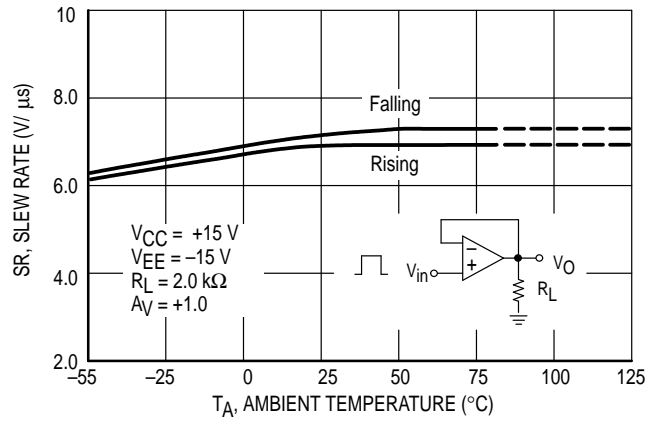

Figure 11. Slew Rate versus Supply Voltage

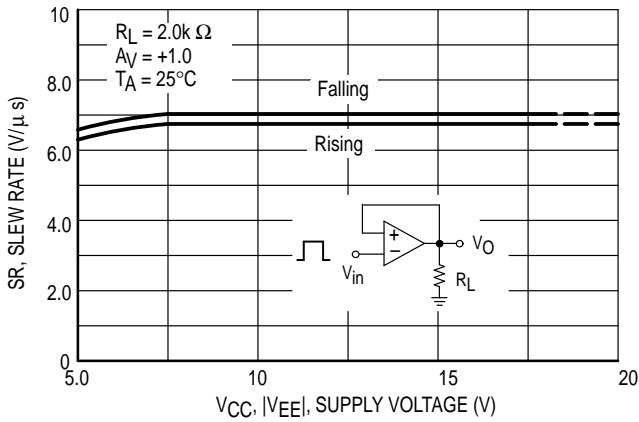

Figure 12. Output Voltage versus Frequency

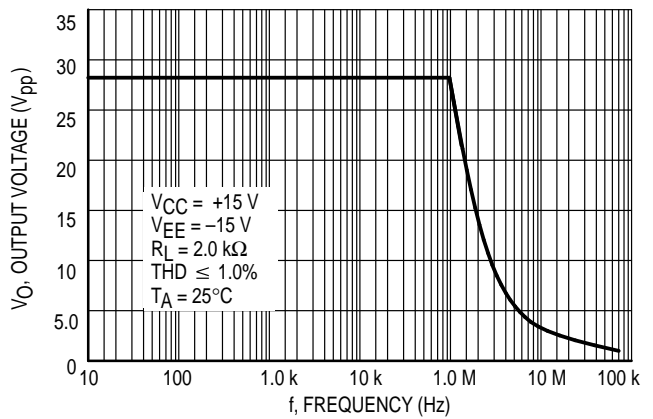

Figure 13. Maximum Output Voltage versus Supply Voltage

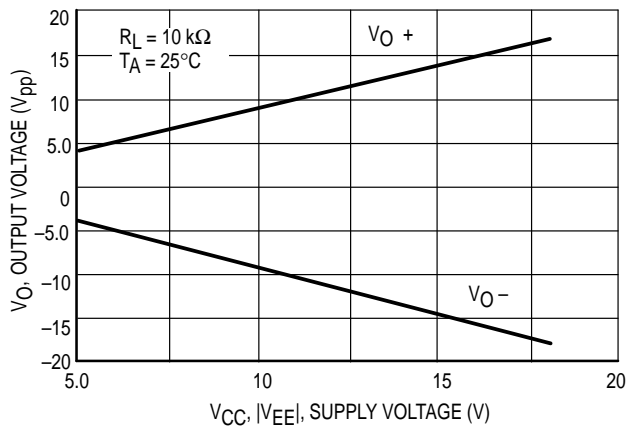

Figure 14. Output Saturation Voltage versus Temperature

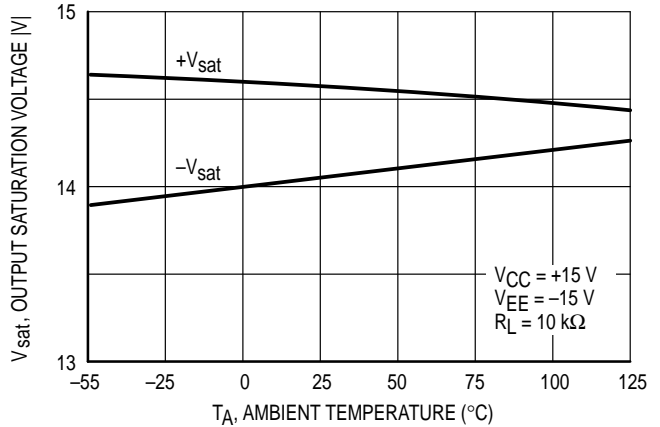

Figure 15. Power Supply Rejection versus Frequency

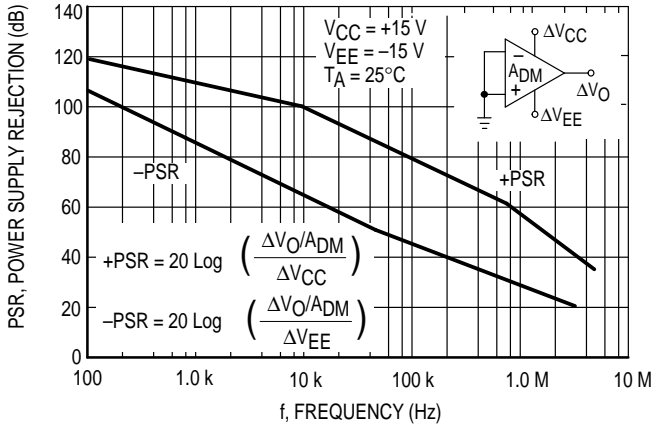

Figure 16. Common Mode Rejection versus Frequency

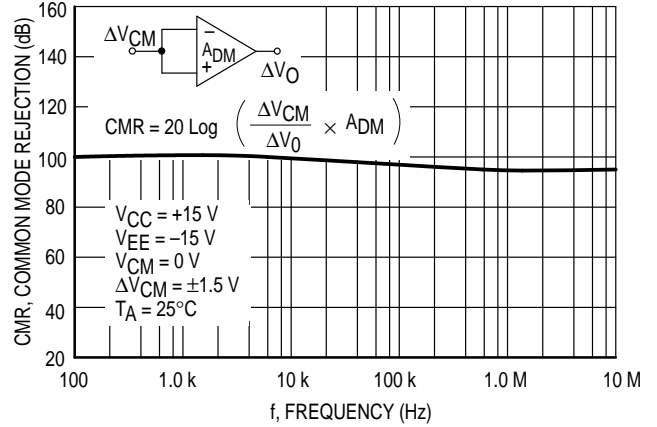

Figure 17. Total Harmonic Distortion versus Frequency

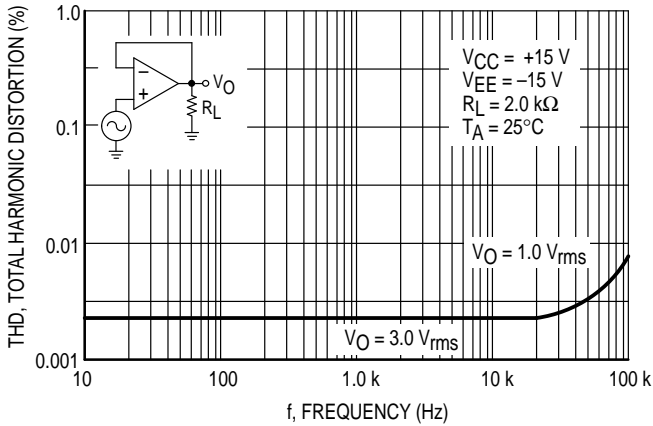

Figure 18. Input Referred Noise Voltage versus Frequency

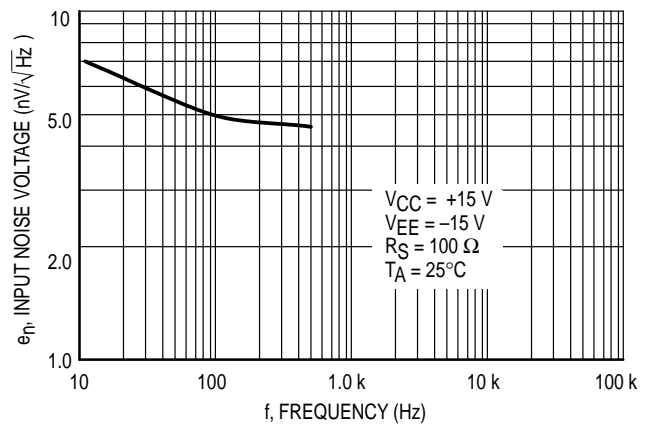

Figure 19. Input Referred Noise Current versus Frequency

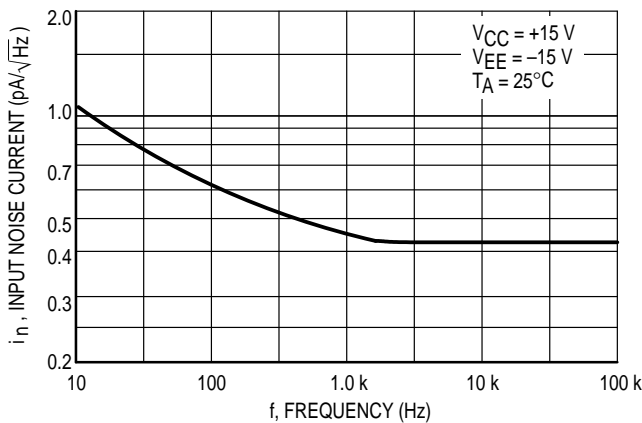

Figure 20. Input Referred Noise Voltage versus Source Resistance

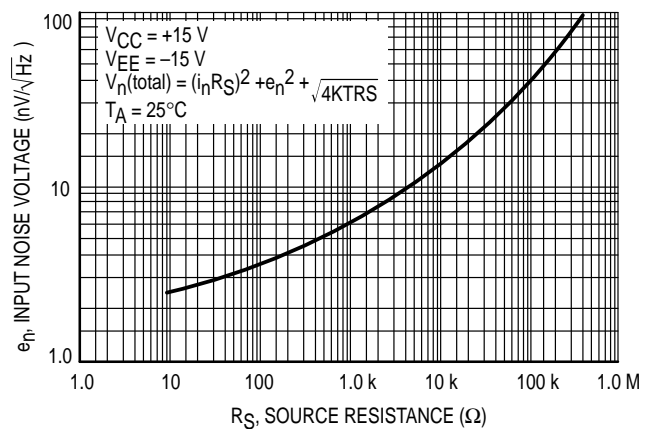

Figure 21. Inverting Amplifier

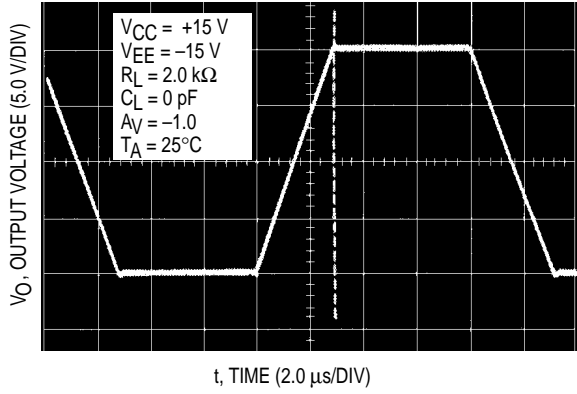

Figure 22. Noninverting Amplifier Slew Rate

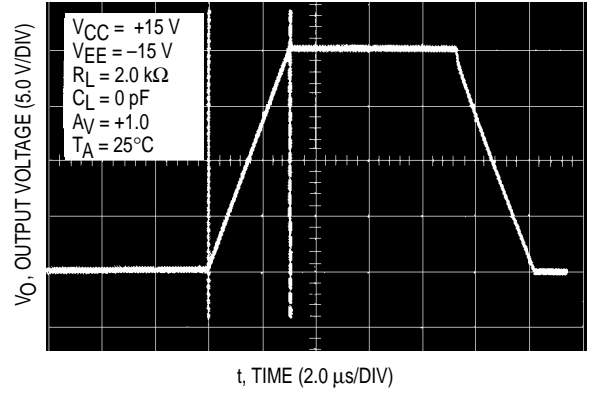
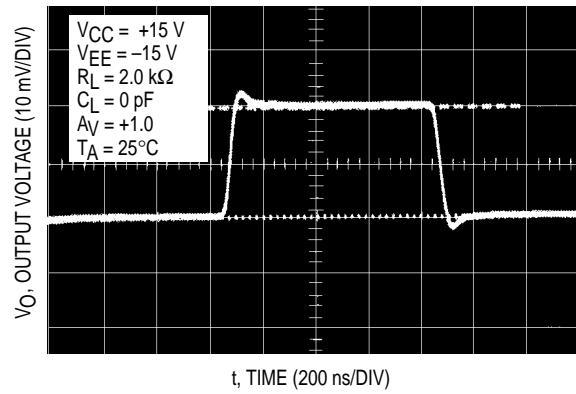

Figure 23. Noninverting Amplifier Overshoot



LM833

OUTLINE DIMENSIONS

N SUFFIX PLASTIC PACKAGE CASE 626-05 ISSUE K

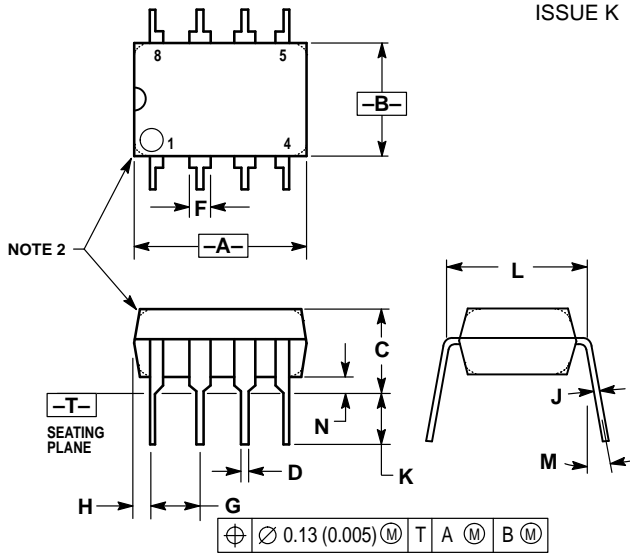

NOTES:

1. DIMENSION L TO CENTER OF LEAD WHEN FORMED PARALLEL.
2. PACKAGE CONTOUR OPTIONAL (ROUND OR SQUARE CORNERS).
3. DIMENSIONING AND TOLERANCING PER ANSI Y14.5M, 1982.

DIM	MILLIMETERS		INCHES	
	MIN	MAX	MIN	MAX
A	9.40	10.16	0.370	0.400
B	6.10	6.60	0.240	0.260
C	3.94	4.45	0.155	0.175
D	0.38	0.51	0.015	0.020
F	1.02	1.78	0.040	0.070
G	2.54 BSC		0.100 BSC	
H	0.76	1.27	0.030	0.050
J	0.20	0.30	0.008	0.012
K	2.92	3.43	0.115	0.135
L	7.62 BSC		0.300 BSC	
M	— 10°		— 10°	
N	0.76	1.01	0.030	0.040

D SUFFIX PLASTIC PACKAGE CASE 751-05 (SO-8) ISSUE R

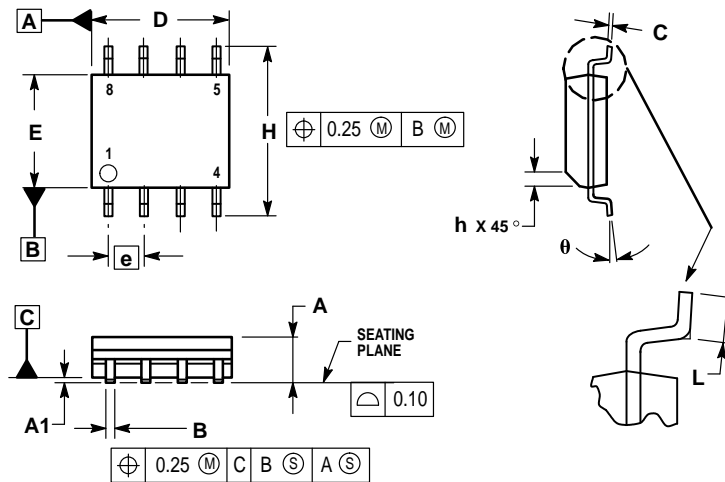

NOTES:

1. DIMENSIONING AND TOLERANCING PER ASME Y14.5M, 1994.
2. DIMENSIONS ARE IN MILLIMETERS.
3. DIMENSION D AND E DO NOT INCLUDE MOLD PROTRUSION.
4. MAXIMUM MOLD PROTRUSION 0.15 PER SIDE.
5. DIMENSION B DOES NOT INCLUDE MOLD PROTRUSION. ALLOWABLE DAMBAR PROTRUSION SHALL BE 0.127 TOTAL IN EXCESS OF THE B DIMENSION AT MAXIMUM MATERIAL CONDITION.

DIM	MILLIMETERS	
	MIN	MAX
A	1.35	1.75
A1	0.10	0.25
B	0.35	0.49
C	0.18	0.25
D	4.80	5.00
E	3.80	4.00
e	1.27 BSC	
H	5.80	6.20
h	0.25	0.50
L	0.40	1.25
θ	0°	7°

LM833

Motorola reserves the right to make changes without further notice to any products herein. Motorola makes no warranty, representation or guarantee regarding the suitability of its products for any particular purpose, nor does Motorola assume any liability arising out of the application or use of any product or circuit, and specifically disclaims any and all liability, including without limitation consequential or incidental damages. "Typical" parameters which may be provided in Motorola data sheets and/or specifications can and do vary in different applications and actual performance may vary over time. All operating parameters, including "Typicals" must be validated for each customer application by customer's technical experts. Motorola does not convey any license under its patent rights nor the rights of others. Motorola products are not designed, intended, or authorized for use as components in systems intended for surgical implant into the body, or other applications intended to support or sustain life, or for any other application in which the failure of the Motorola product could create a situation where personal injury or death may occur. Should Buyer purchase or use Motorola products for any such unintended or unauthorized application, Buyer shall indemnify and hold Motorola and its officers, employees, subsidiaries, affiliates, and distributors harmless against all claims, costs, damages, and expenses, and reasonable attorney fees arising out of, directly or indirectly, any claim of personal injury or death associated with such unintended or unauthorized use, even if such claim alleges that Motorola was negligent regarding the design or manufacture of the part. Motorola and  are registered trademarks of Motorola, Inc. Motorola, Inc. is an Equal Opportunity/Affirmative Action Employer.

How to reach us:

USA/EUROPE/Locations Not Listed: Motorola Literature Distribution;
P.O. Box 20912; Phoenix, Arizona 85036. 1-800-441-2447 or 602-303-5454

MFAX: RMFAX0@email.sps.mot.com – TOUCHTONE 602-244-6609
INTERNET: <http://Design-NET.com>

JAPAN: Nippon Motorola Ltd.; Tatsumi-SPD-JLDC, 6F Seibu-Butsuryu-Center,
3-14-2 Tatsumi Koto-Ku, Tokyo 135, Japan. 03-81-3521-8315

ASIA/PACIFIC: Motorola Semiconductors H.K. Ltd.; 8B Tai Ping Industrial Park,
51 Ting Kok Road, Tai Po, N.T., Hong Kong. 852-26629298



MOTOROLA



LM833/D

