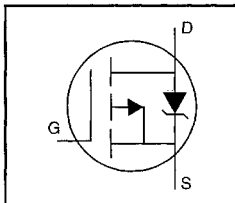


## HEXFET® Power MOSFET

- Dynamic dv/dt Rating
- Repetitive Avalanche Rated
- P-Channel
- 175°C Operating Temperature
- Fast Switching
- Ease of Paralleling
- Simple Drive Requirements



$$V_{DSS} = -60V$$

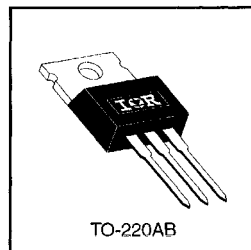
$$R_{DS(on)} = 0.50\Omega$$

$$I_D = -6.7A$$

### Description

Third Generation HEXFETs from International Rectifier provide the designer with the best combination of fast switching, ruggedized device design, low on-resistance and cost-effectiveness.

The TO-220 package is universally preferred for all commercial-industrial applications at power dissipation levels to approximately 50 watts. The low thermal resistance and low package cost of the TO-220 contribute to its wide acceptance throughout the industry.



TO-220AB

DATA  
SHEETS

### Absolute Maximum Ratings

Parameter	Max.	Units
$I_D @ T_C = 25^\circ\text{C}$	-6.7	A
$I_D @ T_C = 100^\circ\text{C}$	-4.7	
$I_{DM}$	-27	
$P_D @ T_C = 25^\circ\text{C}$	43	W
	0.29	W/°C
$V_{GS}$	$\pm 20$	V
$E_{AS}$	140	mJ
$I_{AR}$	-6.7	A
$E_{AR}$	4.3	mJ
dv/dt	-4.5	V/ns
$T_J$	-55 to +175	°C
$T_{STG}$		
	300 (1.6mm from case)	
	10 lbf•in (1.1 N•m)	

### Thermal Resistance

Parameter	Min.	Typ.	Max.	Units
$R_{\theta JC}$	—	—	3.5	°C/W
$R_{\theta CS}$	—	0.50	—	
$R_{\theta JA}$	—	—	62	

## Electrical Characteristics @ T<sub>J</sub> = 25°C (unless otherwise specified)

	Parameter	Min.	Typ.	Max.	Units	Test Conditions
V <sub>(BR)DSS</sub>	Drain-to-Source Breakdown Voltage	-60	—	—	V	V <sub>GS</sub> =0V, I <sub>D</sub> =-250μA
ΔV <sub>(BR)DSS</sub> /ΔT <sub>J</sub>	Breakdown Voltage Temp. Coefficient	—	-0.060	—	V/°C	Reference to 25°C, I <sub>D</sub> =-1mA
R <sub>DS(on)</sub>	Static Drain-to-Source On-Resistance	—	—	0.50	Ω	V <sub>GS</sub> =-10V, I <sub>D</sub> =-4.0A ④
V <sub>GS(th)</sub>	Gate Threshold Voltage	-2.0	—	-4.0	V	V <sub>DS</sub> =V <sub>GS</sub> , I <sub>D</sub> =-250μA
g <sub>fs</sub>	Forward Transconductance	1.4	—	—	S	V <sub>DS</sub> =-25V, I <sub>D</sub> =-4.0A ④
I <sub>DSS</sub>	Drain-to-Source Leakage Current	—	—	-100	μA	V <sub>DS</sub> =-60V, V <sub>GS</sub> =0V
		—	—	-500		V <sub>DS</sub> =-48V, V <sub>GS</sub> =0V, T <sub>J</sub> =150°C
I <sub>GSS</sub>	Gate-to-Source Forward Leakage	—	—	-100	nA	V <sub>GS</sub> =-20V
	Gate-to-Source Reverse Leakage	—	—	100		V <sub>GS</sub> =20V
Q <sub>g</sub>	Total Gate Charge	—	—	12		I <sub>D</sub> =-6.7A
Q <sub>gs</sub>	Gate-to-Source Charge	—	—	3.8	nC	V <sub>DS</sub> =-48V
Q <sub>gd</sub>	Gate-to-Drain ("Miller") Charge	—	—	5.1		V <sub>GS</sub> =-10V See Fig. 6 and 13 ④
t <sub>d(on)</sub>	Turn-On Delay Time	—	11	—	ns	V <sub>DD</sub> =-30V I <sub>D</sub> =-6.7A R <sub>G</sub> =24Ω R <sub>D</sub> =4.0Ω See Figure 10 ④
t <sub>r</sub>	Rise Time	—	63	—		
t <sub>d(off)</sub>	Turn-Off Delay Time	—	10	—		
t <sub>f</sub>	Fall Time	—	31	—		
L <sub>D</sub>	Internal Drain Inductance	—	4.5	—	nH	Between lead, 6 mm (0.25in.) from package and center of die contact
L <sub>S</sub>	Internal Source Inductance	—	7.5	—		
C <sub>iss</sub>	Input Capacitance	—	270	—	pF	V <sub>GS</sub> =0V V <sub>DS</sub> =-25V f=1.0MHz See Figure 5
C <sub>oss</sub>	Output Capacitance	—	170	—		
C <sub>rss</sub>	Reverse Transfer Capacitance	—	31	—		



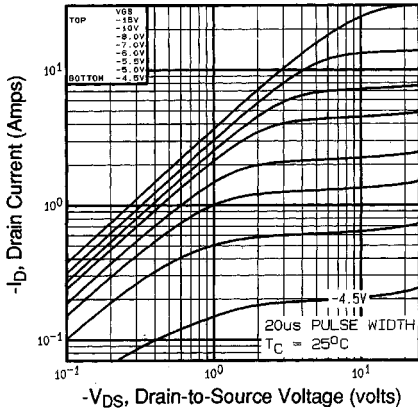
## Source-Drain Ratings and Characteristics

	Parameter	Min.	Typ.	Max.	Units	Test Conditions
I <sub>S</sub>	Continuous Source Current (Body Diode)	—	—	-6.7	A	MOSFET symbol showing the integral reverse p-n junction diode.
I <sub>SM</sub>	Pulsed Source Current (Body Diode) ①	—	—	-27		
V <sub>SD</sub>	Diode Forward Voltage	—	—	-5.5	V	T <sub>J</sub> =25°C, I <sub>S</sub> =-6.7A, V <sub>GS</sub> =0V ④
t <sub>rr</sub>	Reverse Recovery Time	—	80	160	ns	T <sub>J</sub> =25°C, I <sub>F</sub> =-6.7A
Q <sub>rr</sub>	Reverse Recovery Charge	—	0.096	0.19	μC	di/dt=100A/μs ④
t <sub>on</sub>	Forward Turn-On Time	Intrinsic turn-on time is negligible (turn-on is dominated by L <sub>S</sub> +L <sub>D</sub> )				

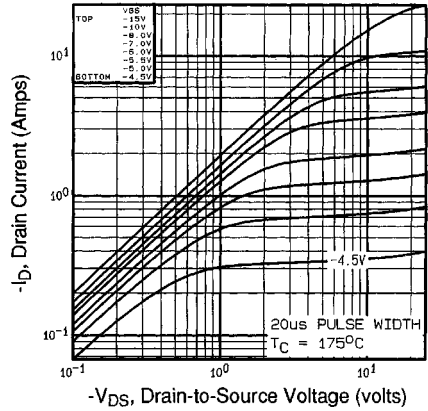


### Notes:

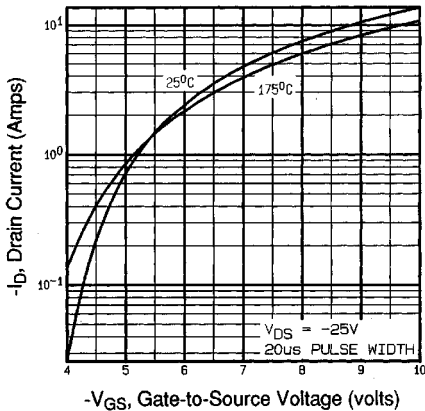
- ① Repetitive rating; pulse width limited by max. junction temperature (See Figure 11)
- ② V<sub>DD</sub>=-25V, starting T<sub>J</sub>=25°C, L=3.6mH R<sub>G</sub>=25Ω, I<sub>AS</sub>=-6.7A (See Figure 12)
- ③ I<sub>SD</sub>≤-6.7A, di/dt≤90A/μs, V<sub>DD</sub>≤V<sub>(BR)DSS</sub>, T<sub>J</sub>≤175°C
- ④ Pulse width ≤ 300 μs; duty cycle ≤2%.



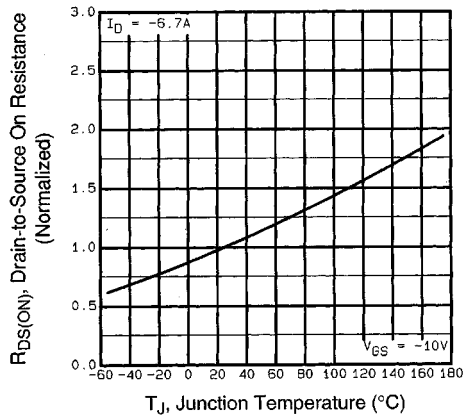
**Fig 1.** Typical Output Characteristics,  
 $T_C=25^\circ\text{C}$



**Fig 2.** Typical Output Characteristics,  
 $T_C=175^\circ\text{C}$

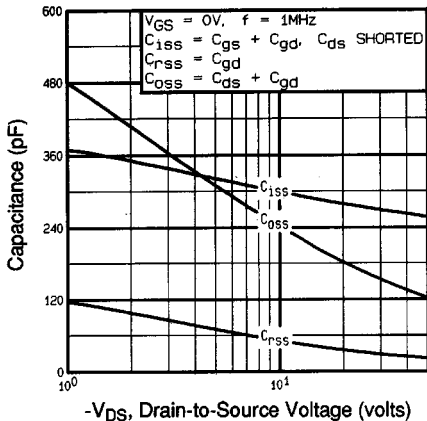


**Fig 3.** Typical Transfer Characteristics

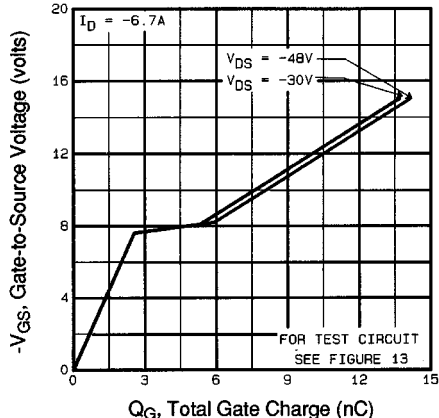


**Fig 4.** Normalized On-Resistance  
Vs. Temperature

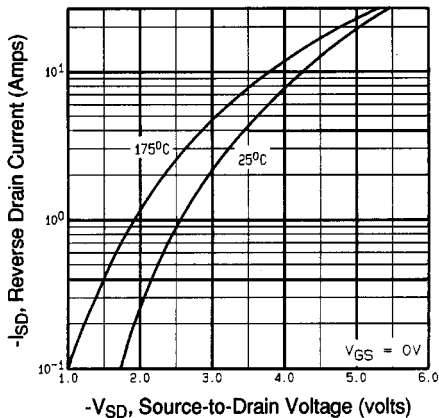
DATA SHEETS



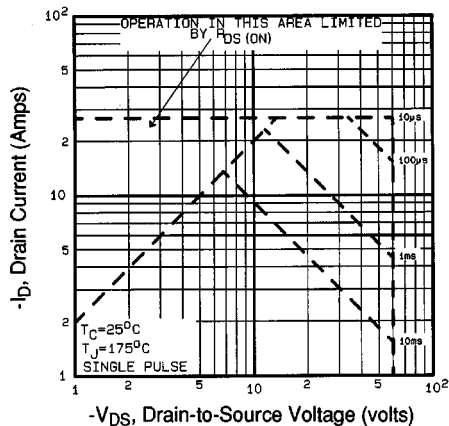
**Fig 5.** Typical Capacitance Vs. Drain-to-Source Voltage



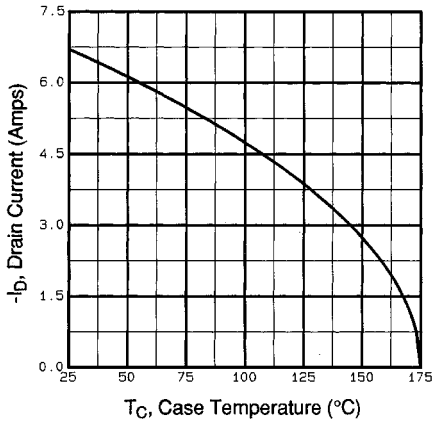
**Fig 6.** Typical Gate Charge Vs. Gate-to-Source Voltage



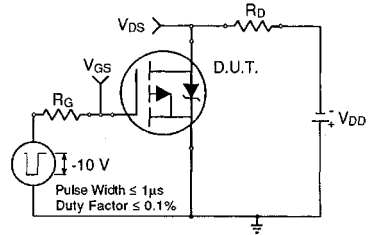
**Fig 7.** Typical Source-Drain Diode Forward Voltage



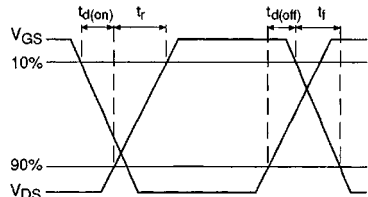
**Fig 8.** Maximum Safe Operating Area



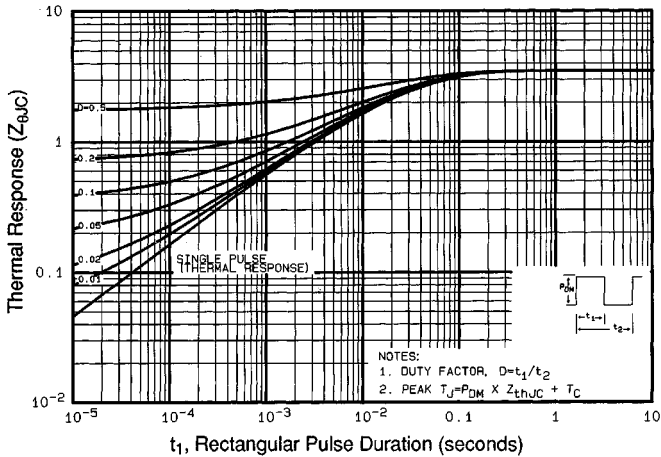
**Fig 9.** Maximum Drain Current Vs. Case Temperature



**Fig 10a.** Switching Time Test Circuit

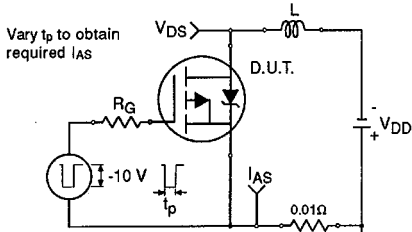


**Fig 10b.** Switching Time Waveforms

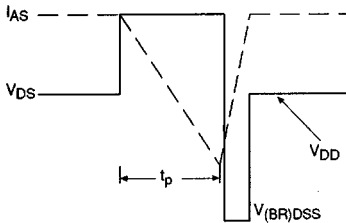


**Fig 11.** Maximum Effective Transient Thermal Impedance, Junction-to-Case

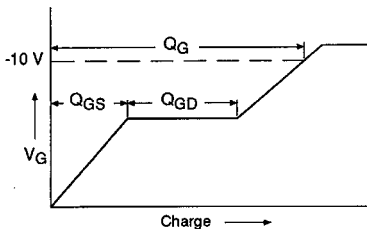
DATA SHEETS



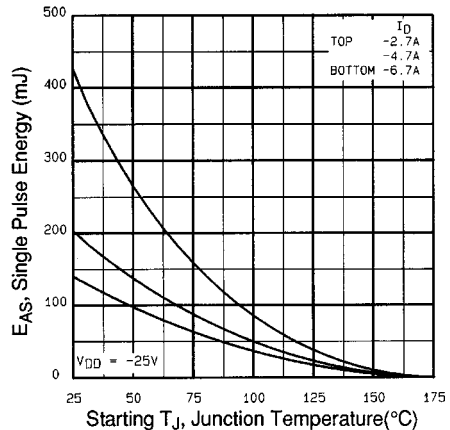
**Fig 12a.** Unclamped Inductive Test Circuit



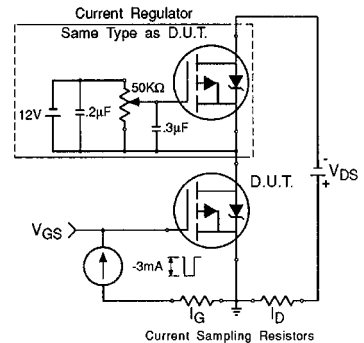
**Fig 12b.** Unclamped Inductive Waveforms



**Fig 13a.** Basic Gate Charge Waveform



**Fig 12c.** Maximum Avalanche Energy Vs. Drain Current



**Fig 13b.** Gate Charge Test Circuit

**Appendix A:** Figure 14, Peak Diode Recovery  $dv/dt$  Test Circuit – See page 1506

**Appendix B:** Package Outline Mechanical Drawing – See page 1509

**Appendix C:** Part Marking Information – See page 1516

**Appendix E:** Optional Leadforms – See page 1525